

A Network of Time-Division Multiplexed Wiring for FPGAs

Rosemary Francis

Simon Moore

Robert Mullins

Motivation

- FPGAs are now home to complex Systems on-Chip
- ...but still optimised for single-core designs
- FPGA global wiring is simple in comparison with ASIC Networks-on-Chip
- Networks for FPGAs use lots of logic
- Hard blocks are limited by the soft IP blocks

Goals

- Use TDM components for effective soft NoC implementation
- Funnel data to high-speed hard blocks
 - Hard NoC
 - Multipliers
 - Block RAM
- Determine optimum TDM architecture
 - What are the costs?
 - Is it possible to design for global and local routing?

Hierarchy of interconnect

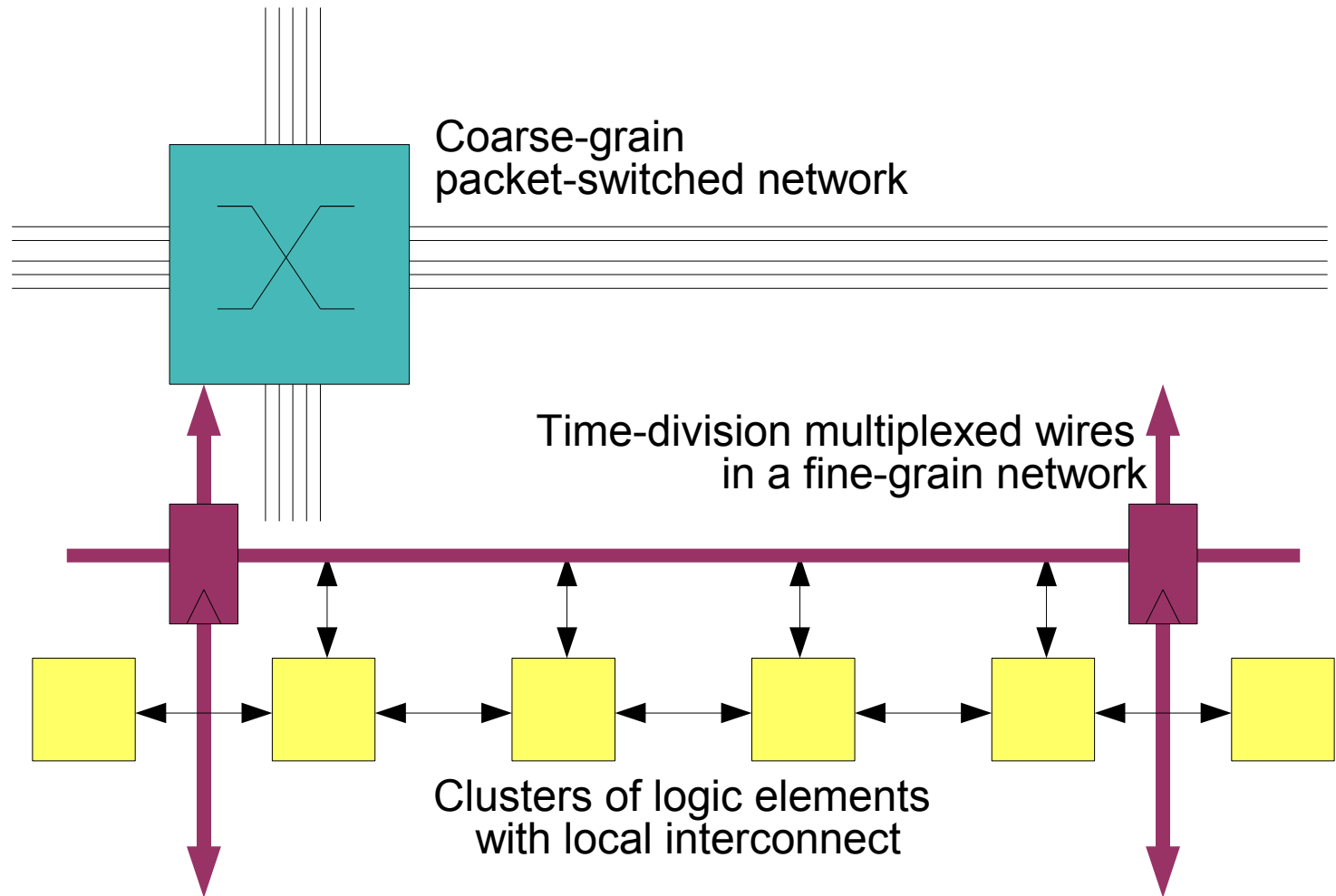

Architecture: Stratix vs TDM

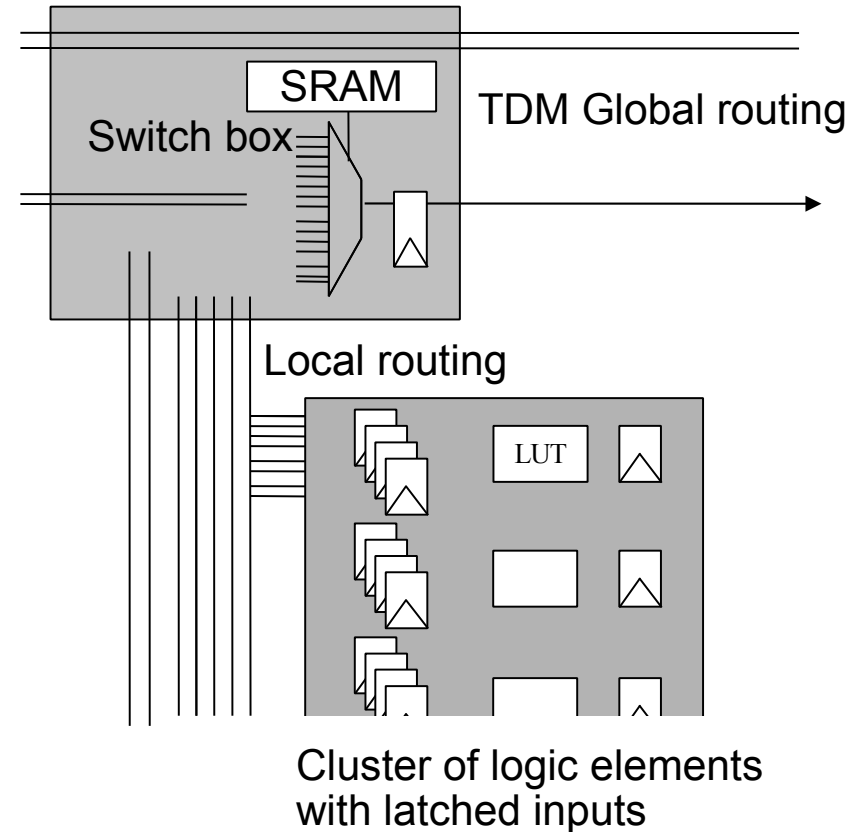
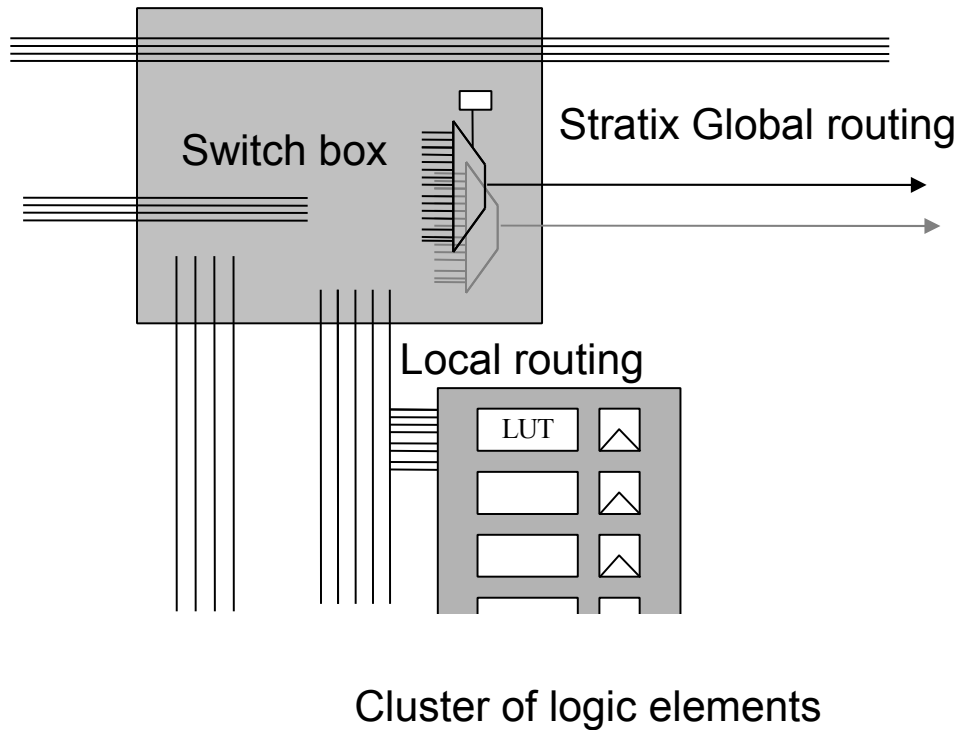

Wire Sharing

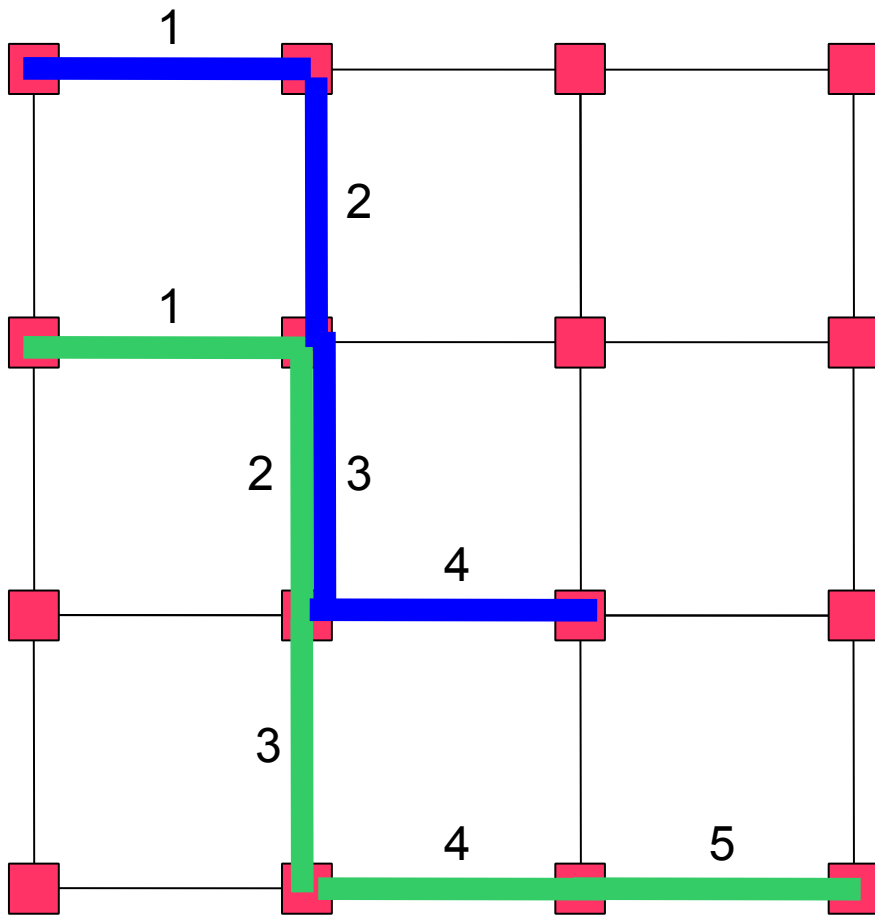

- Many wires can be shared without a problem

Wire Sharing

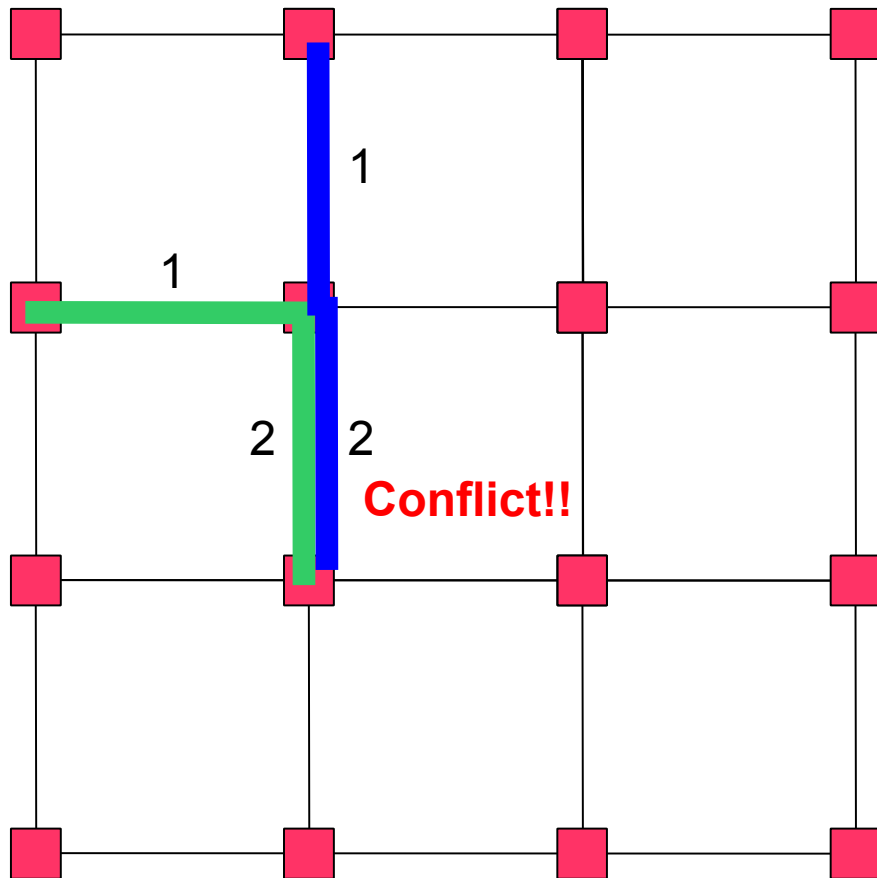

- Many wires can be shared without a problem
- Other configurations require a more intelligent approach

Wire Sharing

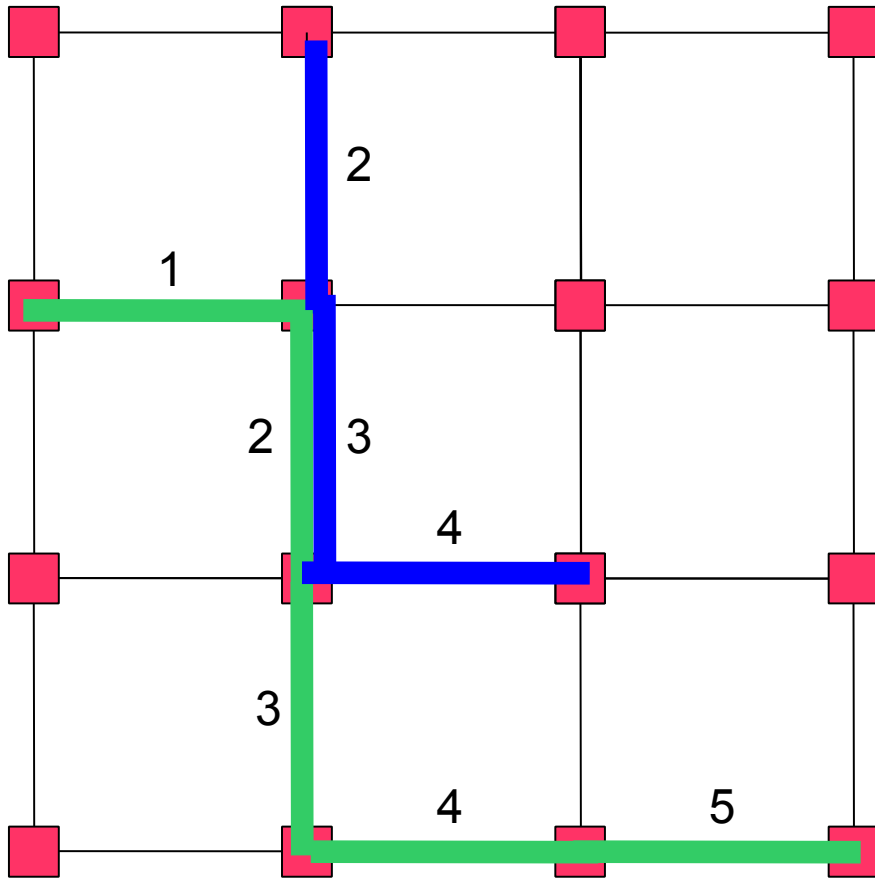

- Many wires can be shared without a problem
- Other configurations require a more intelligent approach
- Signals can be delayed to allow more efficient wire use without rerouting

Our Scheduler

- Our scheduler
 - maps benchmarks from a Stratix FPGA to a TDM FPGA
 - resolved TDM conflicts after place and route
- Benchmarks
 - IP cores taken from the Altera University Suite
- Aim
 - To reduce the amount of wiring as far as possible using TDM wiring with realistic characteristics

Parameter selection (1 of 3)

- Assume infinite time slots to reduce wiring
 - Determine minimum number of TDM wires

Infinite number of time slots

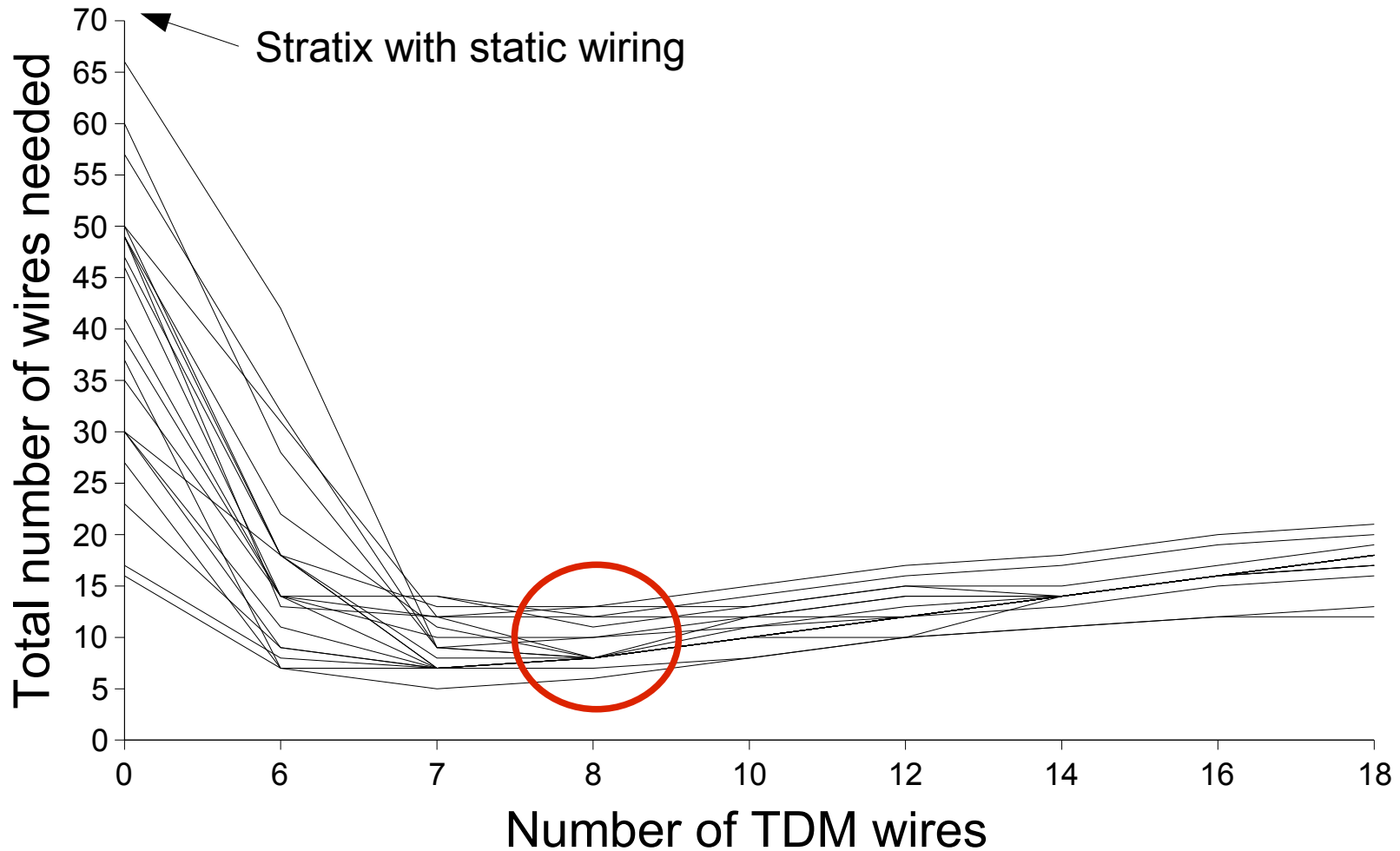

Parameter selection (2 of 3)

- Assume infinite time slots to reduce wiring
 - Determine minimum number of TDM wires
- Vary number of time slots
 - Determine optimum number of time slots
 - Investigate the effect this has on latency

Determine number of time slots

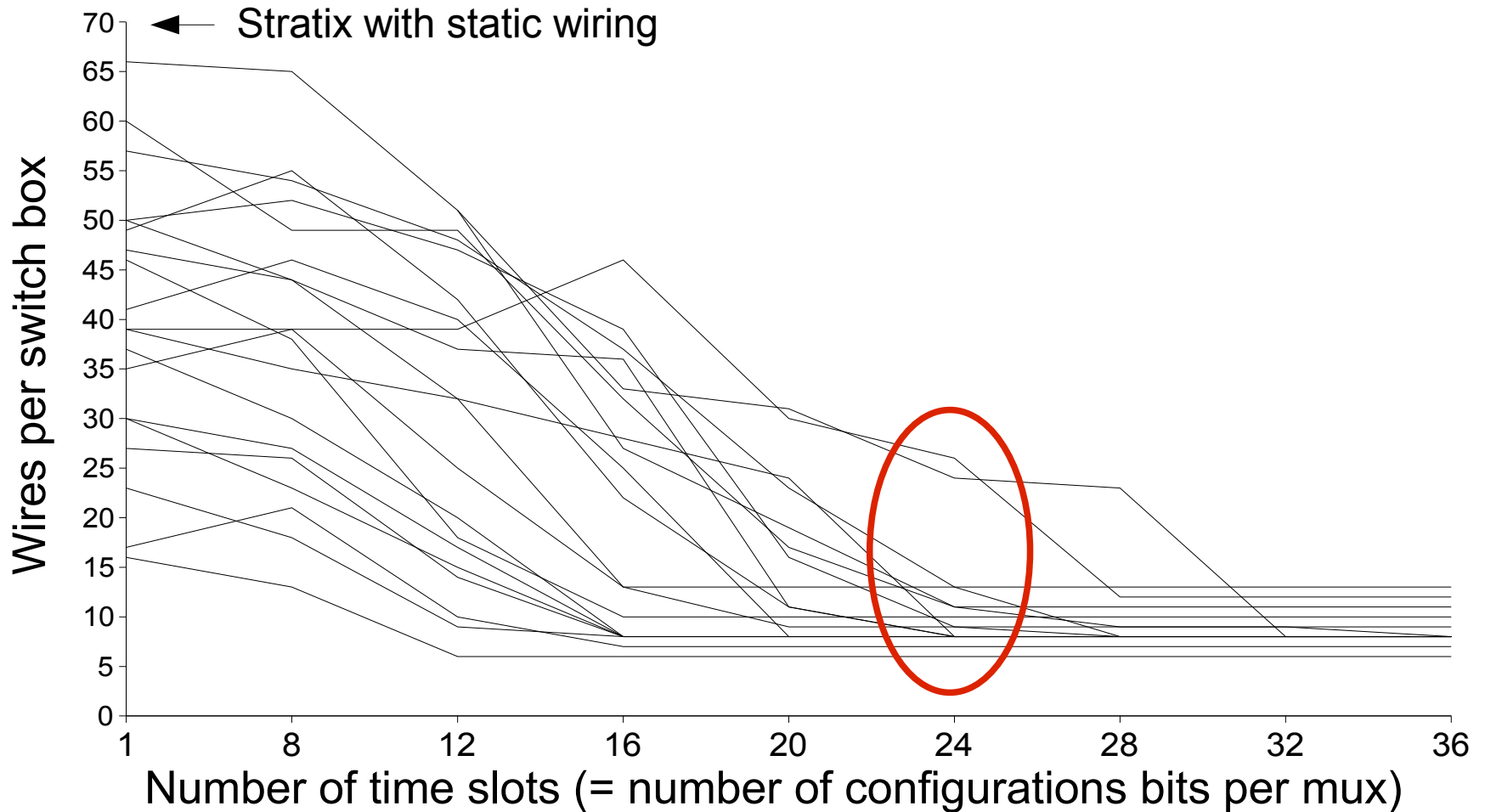

Number of time slots vs latency

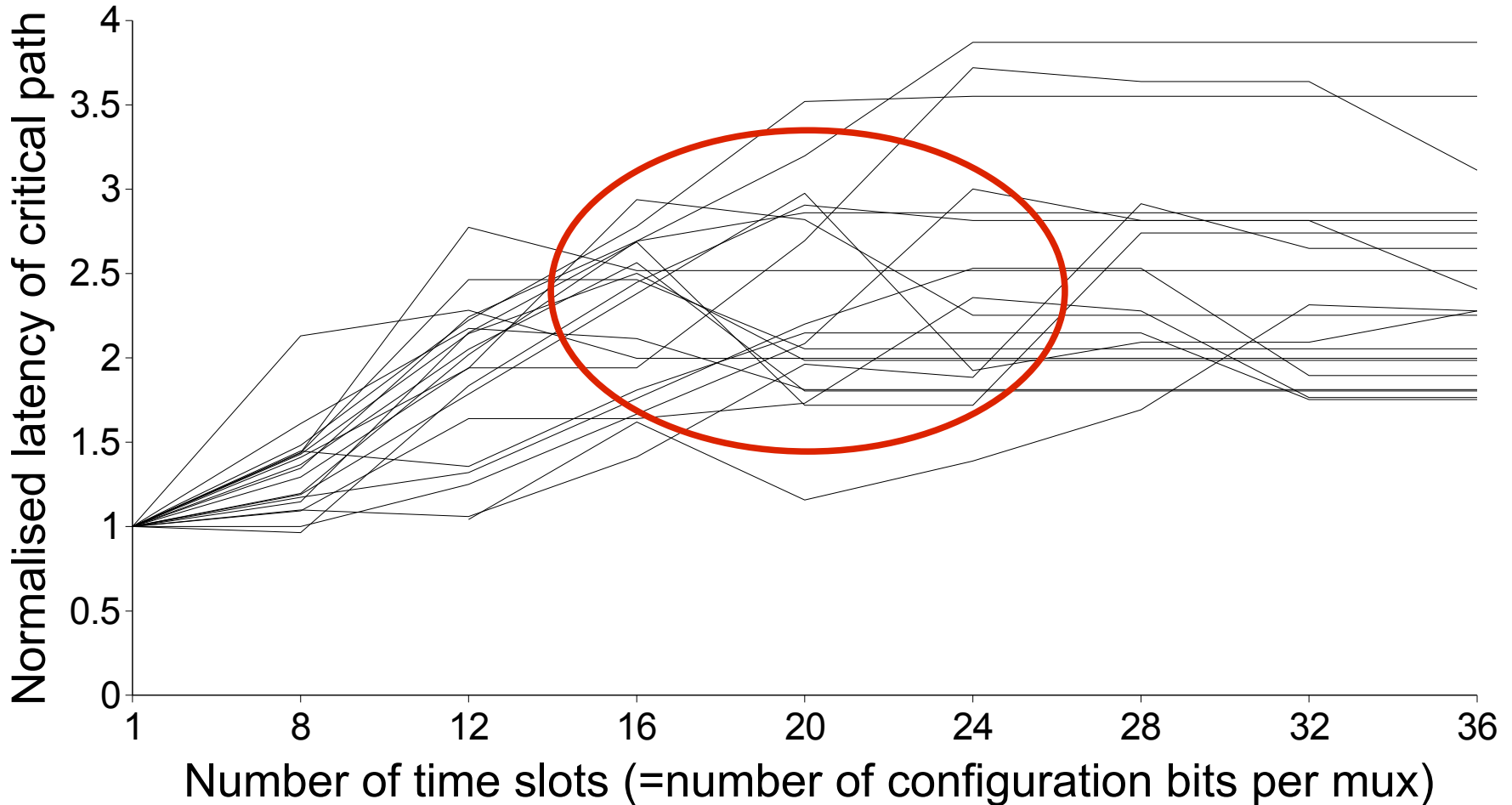

Parameter selection (3 of 3)

- Assume infinite time slots to reduce wiring
 - Determine minimum number of TDM wires
- Vary number of time slots
 - Determine optimum number of time slots
 - Investigate the effect this has on latency
- **Using optimum number of time slots**
 - Re-evaluate optimum number of TDM wires

Limited resources

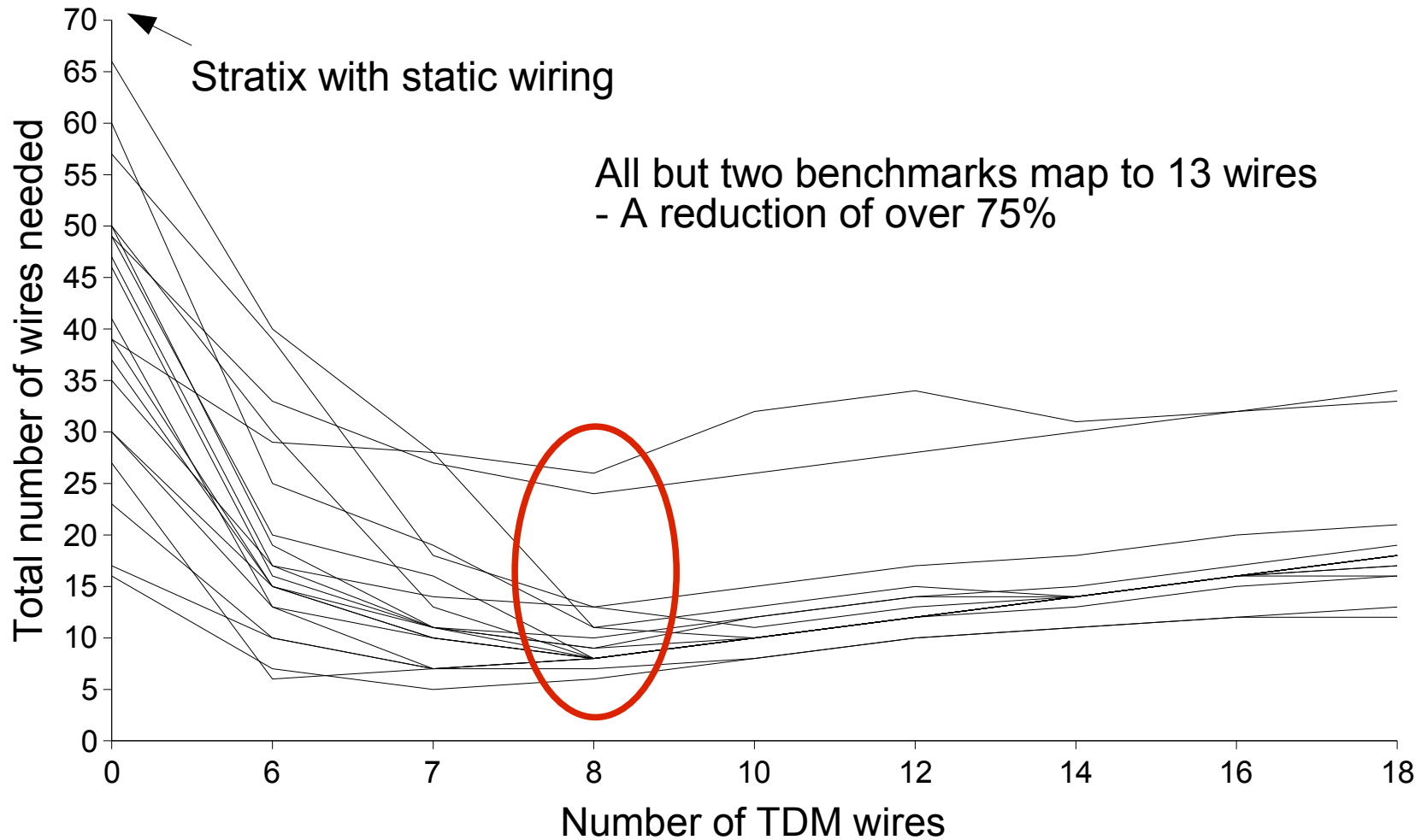

Architectural drawbacks

- Extra configuration SRAM
- High-speed interconnect clock
- Benchmarks run over three times slower
- New CAD tools needed
 - Re-routing in space as well as time
 - Optimise for TDM wiring at every stage

Conclusions

- Using TDM wiring we can reduce the number of wires whilst increasing the data rate within channels
 - 75% less wiring * 24 time slots * 3 times slower means 2 times channel data rate
- This will allow
 - the design of effective global interconnect
 - more efficient sharing of on-chip resources
 - simplification of multi-chip designs

Future Work

- Current scheduling algorithm gives
 - Large wire reduction, large latency penalty
- We are investigating a better compromise
 - Small wiring reduction, small latency penalties?
 - Recent new results show this is possible
- Area and power
 - Is the wiring reduction enough to justify the extra area and power costs?

Thanks for listening...

Rosemary.Francis@cl.cam.ac.uk