



Detection of Specific Sequences Among DNA Fragments Separated by Gel Electrophoresis

E. M. SOUTHERN

J. Of Mol. Biol. (1975) **98**, 503-517

About Edwin M. Southern

Professor Sir Edwin Mellor Southern (1938 - ?)

- Fellow of the Royal Society, Knight Bachelor
- A 2005 Lasker Award-winning molecular biologist
- Medical research council mammalian genome unit, University of Edinburgh (1967)
- Biochemistry professor at the University of Oxford, Trinity College fellow (1985)
- Founded Oxford Gene Technology, and EM Southern Trust, now the Edina Trust
- Some achievements: (http://www.bioch.ox.ac.uk/glycob/rodney_porter_lectures/2006/southern.html)
 - **Southern blot**
 - earliest DNA sequencing / analysis of satellite DNAs / tandem repeats
 - type II restriction endonucleases
 - internal promoters of RNA polymerase III
 - ribosomal and histone genes / methylation patterns /
 - **first human genome mapping project / DNA sequencing**
 - **oligonucleotide arrays or “DNA chips“ (Microarray technology)**



<http://images.vertmarkets.com/crlive/files/Images/836827A0-0E5C-11D5-A770-00D0B7694F32/ladder.jpg>

http://www.nature.com/ng/journal/v23/n3/images/ng1199_251c.jpg

Southern Blotting Technique

① Migration and Transfer

The electrophoresis technique is used to generate a gel containing DNA fragments separated by weight in lanes.

DNA fragments migrate with the solution and transfer from the gel to the membrane.

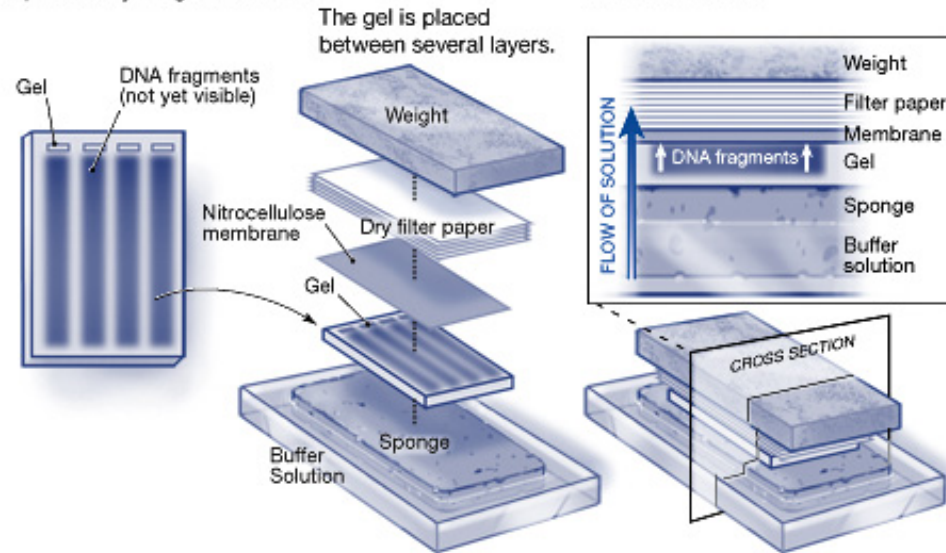

② Labeling

A hybridization technique is used to identify DNA fragments of interest using radiolabeled probe.

③ Visualization and Identification

X-ray film is exposed to the membrane, permitting easy visualization of hybridized radiolabeled fragments.

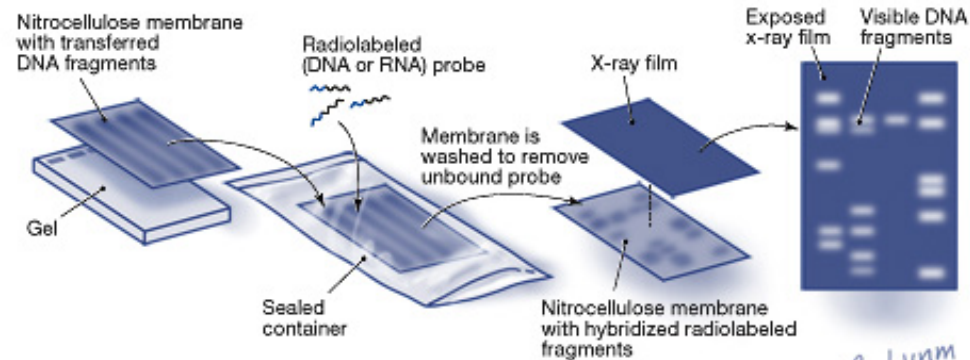

C. Lynn

Before Southern Blot

“Scientists knew that they could chop up DNA using restriction enzymes ... They could then separate the resulting pieces by loading the collection onto an agarose gel and applying an electric current. The pieces would migrate at different rates, depending on size ... For organisms with large genomes, however, this procedure generated a smear of DNA ... Finding a single piece of DNA that carried a specific sequence was hopeless...

Southern realized that he could accomplish his task by brute force: carving the gel into small horizontal slabs, washing the DNA out of each gel slice, attaching every portion to a separate filter, fishing for the particular DNA with a piece of matching, radioactively tagged RNA that would bind to it, and then measuring the amount of bound radioactivity. The tedium and labor involved in such a scheme spurred Southern to think of a better way. “

For Flat Gel

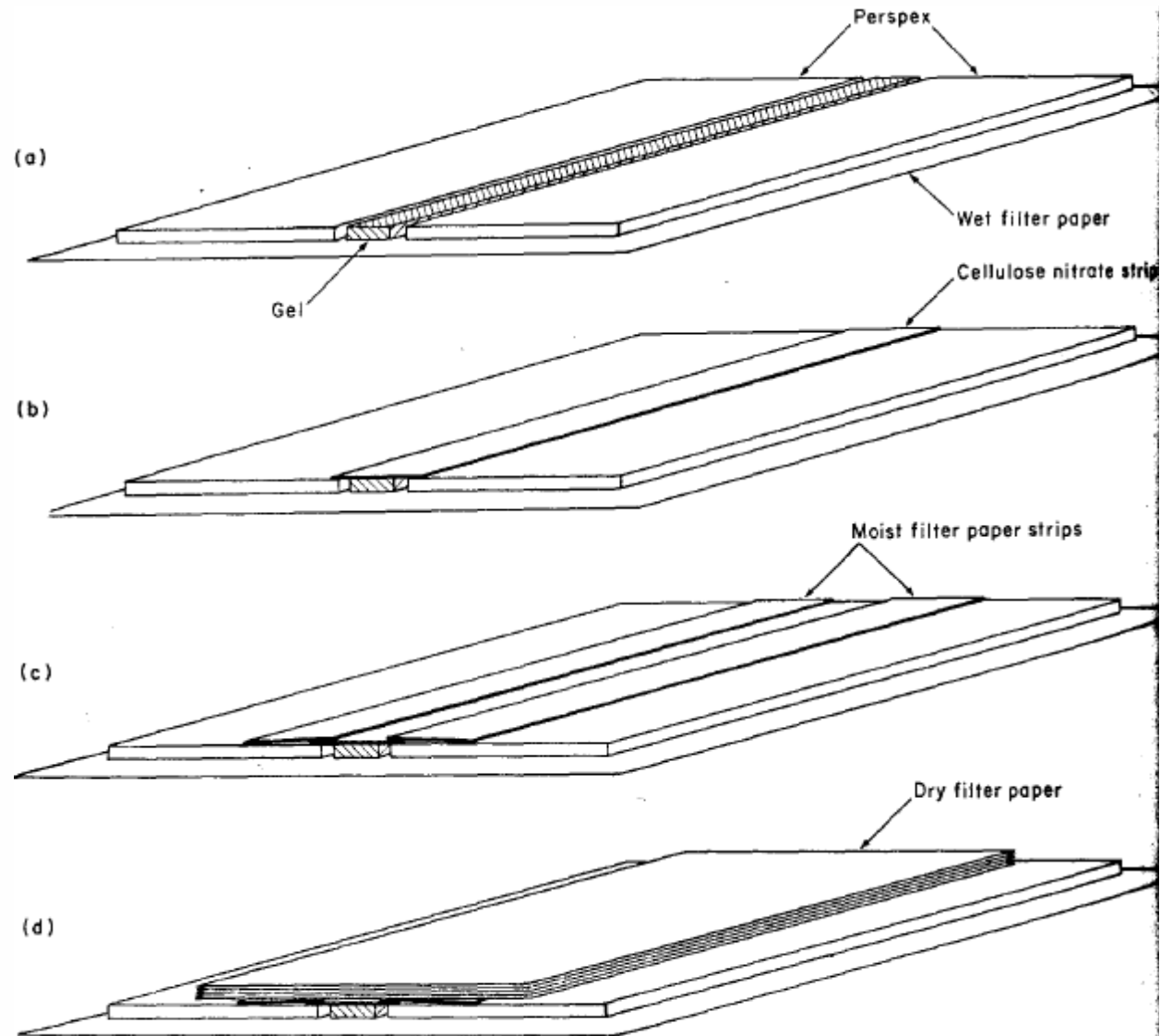

FIG. 1. Steps in the procedure for transferring DNA from agarose gels to cellulose nitrate strips.

For Cylindrical Gel

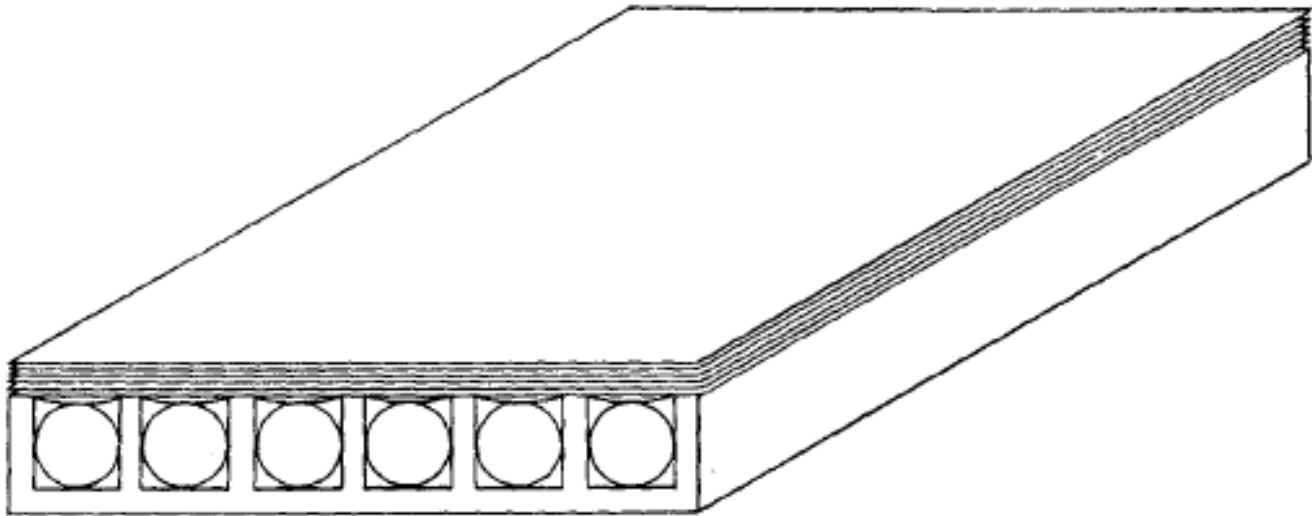
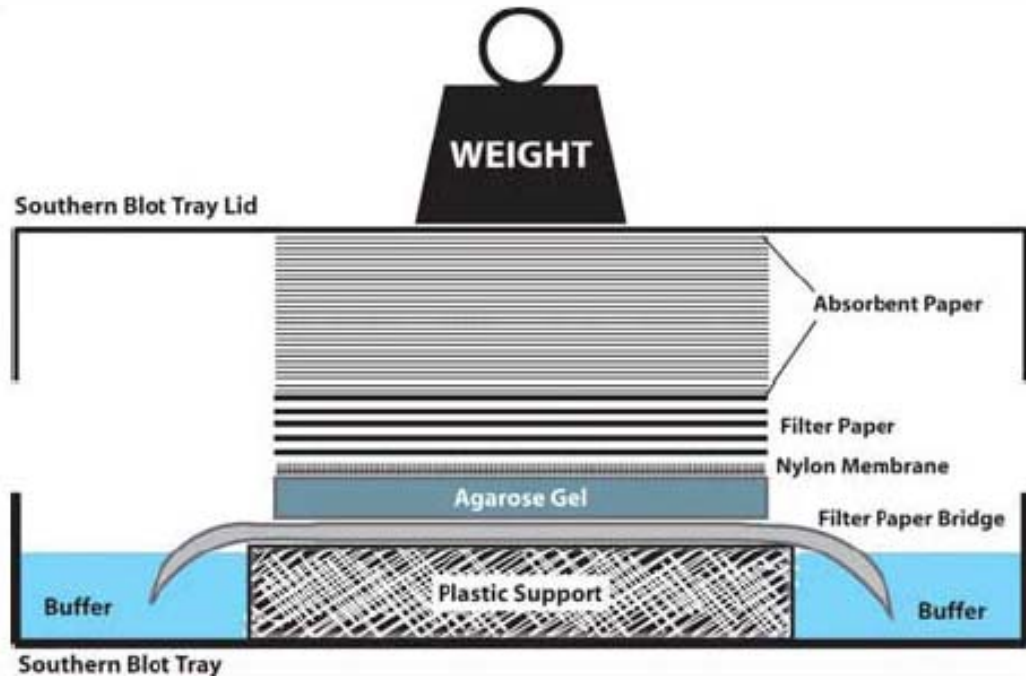

FIG. 2. Apparatus for transferring DNA from a number of cylindrical gels.

Transfer



Hybridization

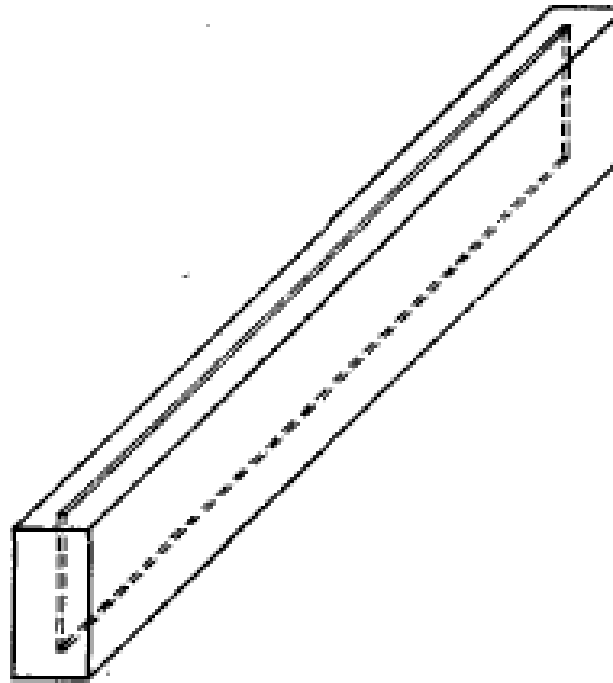

FIG. 3. Vessel used for hybridization of narrow strips.

How it looks like

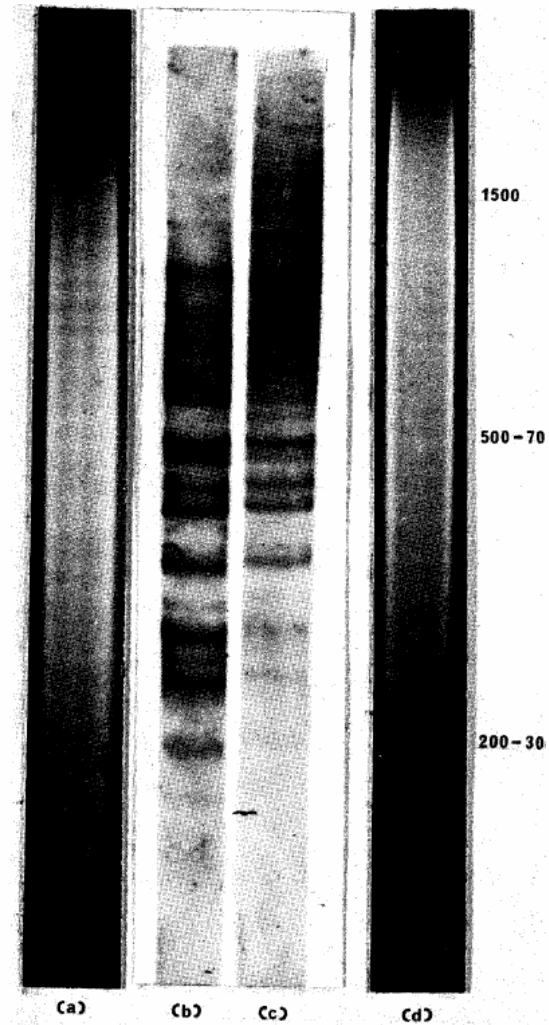

PLATE I. *Hae*III digest of *E. coli* MRE600 DNA analyzed by electrophoresis on 2% agarose gel. DNA was then transferred to cellulose nitrate and hybridized with ^{32}P -labelled, high molecular weight RNA. (a) and (d) Photographs of ethidium bromide fluorescence. (b) and (c) Radioautographs of hybrids.

How it looks like

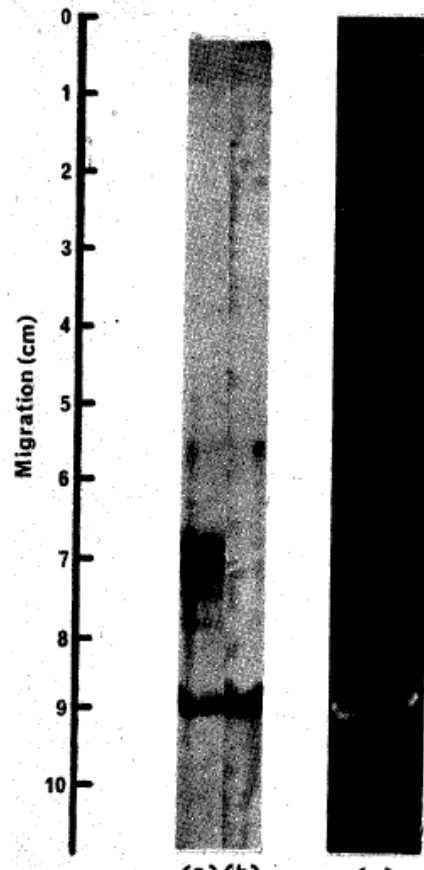

PLATE II. EcoRI digest of purified *X. laevis* ribosomal DNA analyzed by electrophoresis on 1% agarose gel. DNA was transferred to a cellulose nitrate strip, which was then cut longitudinally in two. The left-hand side was hybridized to 18 S RNA and the right-hand side to 28 S RNA (spec. act. of RNAs, 1.5×10^6 c.p.m. per μg). Hybridization was done in $1 \times \text{SSC}$ at 65°C using the vessel shown in Fig. 3. A large excess of cold 28 S RNA was added to the labelled 18 S RNA to compete out any 28 S contamination. After hybridization, the strips were washed in $1 \times \text{SSC}$ at 65°C for 1.5 h, and dried. They were then dipped through a solution of PPO in toluene (20%, w/v) dried in air and placed against Kodak RP Royal X-ray film at -70°C for 2 months. Photograph of ethidium bromide fluorescence (c). Fluorograph of 18 S hybrids (a). Fluorograph of 28 S hybrids (b).

How it looks like

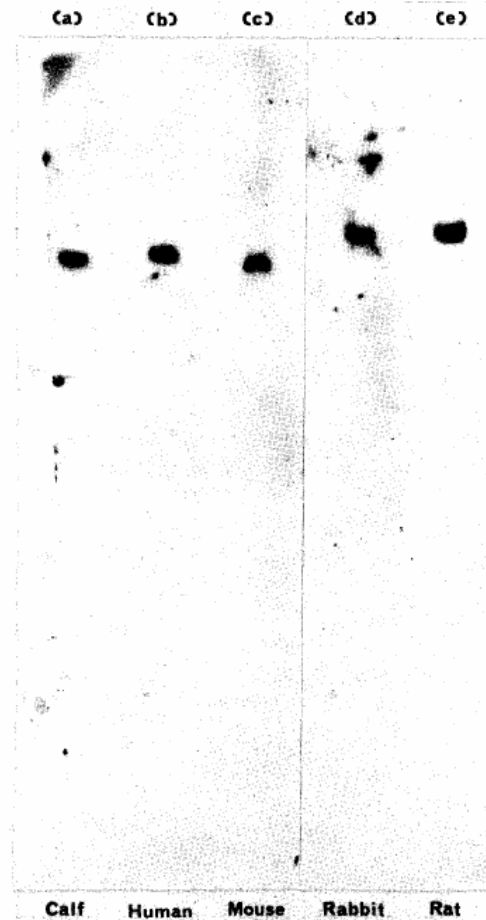

PLATE III. *Eco*RI digests of five mammalian DNAs, hybridized to 28 S RNA. Calf (a), human (b), mouse (c), rabbit (d) and rat (e) DNAs were digested to completion with *Eco*RI and separated by electrophoresis on 1% agarose gels (9mm × 12 cm, approx. 40 μg DNA per tube, 3 mA/tube for 16 h). The gels were pretreated as usual and the DNA fragments transferred to a single sheet of cellulose nitrate filter (12 cm × 8 cm) using the apparatus shown in Fig. 2. The top end of each gel was carefully aligned with one edge of the cellulose nitrate sheet. After 20 h, traces of DNA could still be seen, by ethidium bromide fluorescence, in the high molecular weight region of the gel. The filter was hybridized with 28 S RNA and radioautographed as described in the legend to Fig. 8.

Optimization

TABLE 1
Losses of DNA at stages of the procedure

	EcoRI fragments DNA lost (%)	HaeIII fragments DNA lost (%)
Denaturing solution	2.1	4.8
Neutralizing solution	1.3	4.4
Remaining in gel after transfer	0.21	0.31

Two samples of *E. coli* DNA (0.1 μg ; spec. act. approx. 10^6 c.p.m. per μg) were digested with EcoRI and HaeIII. The fragments were separated by electrophoresis on 1% gels in 1-cm wide slots, and then transferred to cellulose nitrate strips as described in Materials and Methods. The transfer was left overnight. The radioactivity leached out of the gel by the denaturing and neutralizing solutions, that remaining in the gel, and that which had been trapped on the cellulose nitrate filter were measured in a liquid scintillation counter (Cerenkov radiation).

Optimization of transfer condition

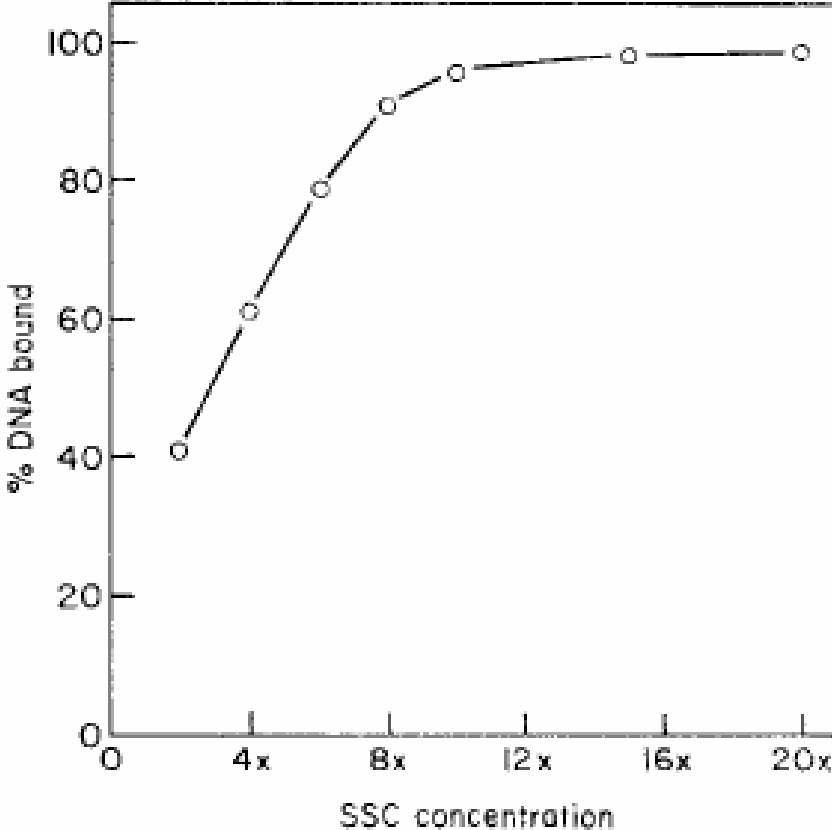

FIG. 4. Effect of salt concentration on efficiency of binding sonicated DNA to cellulose nitrate filters.

Optimization of transfer condition

TABLE 2
Effects of temperature and solvent on retention of sonicated DNA on cellulose nitrate filters

Solvent	50°C	Temperature		
		65°C	80°C	90°C
2 × SSC		77	62	48
6 × SSC		97	76	56
10 × SSC		95	83	73
20 × SSC		97	88	81
6 × SSC in 50% formamide	58	50		

³H-labelled *X. laevis* DNA (spec. act. approx. 5×10^5 c.p.m. per μg) was dissolved in ice-cold $0.1 \times \text{SSC}$ and sonicated in six 15-s bursts. Between each treatment the solution was cooled in ice for 1 min. The solution was boiled for 5 min, made to $20 \times \text{SSC}$ and cooled. Samples of this solution were pipetted on to 13-mm circles of cellulose nitrate, which were then washed in $2 \times \text{SSC}$ at room temperature. Approximately 650 c.p.m. were loaded on each filter, and there was no loss caused by washing in $2 \times \text{SSC}$. The filters were dried, baked at 80°C for 2 h in a vacuum oven and immersed in 10 ml of the solvent equilibrated at the temperature used for incubation. After 90 min, the filters were removed, washed in $2 \times \text{SSC}$ at room temperature, dried under vacuum and counted in a liquid scintillation counter.

Optimization of hybridization condition

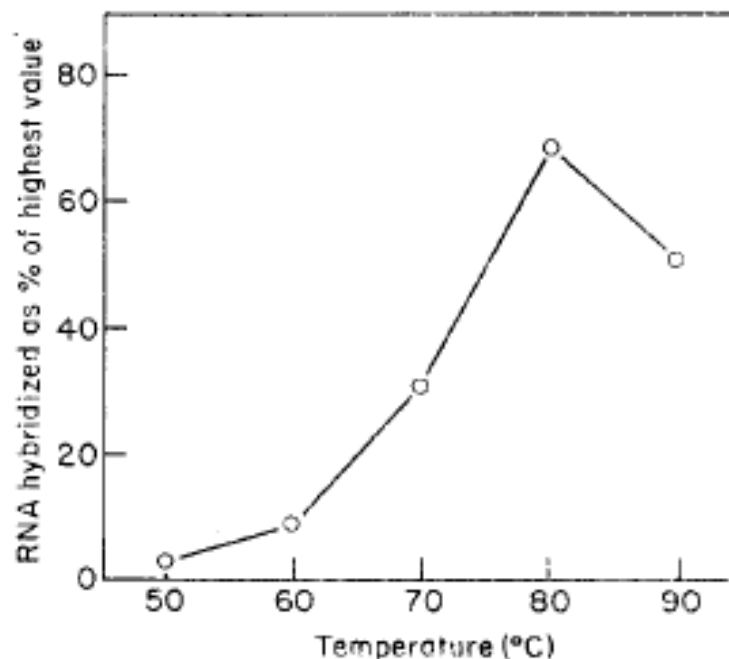

FIG. 5. Temperature dependence of hybridization of 28 S rRNA to *X. laevis* DNA.

X. laevis DNA was loaded on cellulose nitrate filters (17 μg DNA/13-mm diameter disc), which were pretreated as usual for hybridization. ^3H -labelled 28 S RNA from *X. laevis* kidney cells (spec. act. 1.5×10^6 c.p.m./ μg) was dissolved in $6 \times \text{SSC}$ (0.28 $\mu\text{g}/\text{ml}$) and warmed to the temperature used for hybridization. Two filters loaded with DNA and 2 blank filters were introduced into the solutions and left for 30 min. They were washed in 2 l of $2 \times \text{SSC}$ at room temperature, treated with 200 ml of RNAase A (20 $\mu\text{g}/\text{ml}$ in $2 \times \text{SSC}$) at room temperature for 20 min, washed in 200 ml of $2 \times \text{SSC}$ for 10 min, dried under vacuum and counted. Hybridization is expressed as a percentage of that obtained after 5 h at 80°C.

Optimization

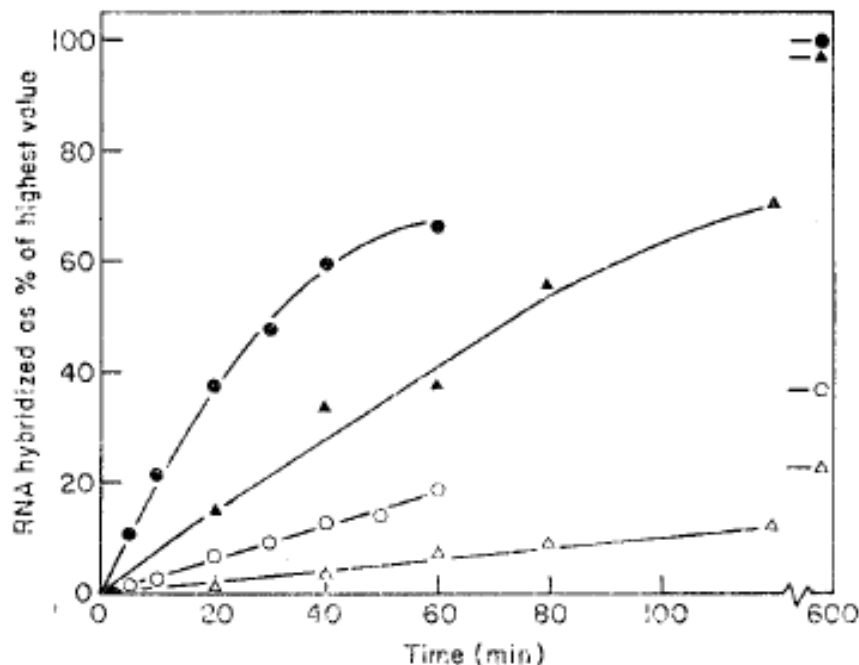

FIG. 6. Time course of hybridization of 28 S RNA to sonicated and high molecular weight DNA at 70 and 80°C.

Filters were loaded as described in the legend to Fig. 5. Two sets were loaded: one with high molecular weight DNA and one with DNA sonicated as described in the legend to Table 2. Hybridization and subsequent treatment of the filters was carried out as described in the legend to Fig. 6 and filters removed at the times indicated. 6 × SSC at 80°C, high molecular weight DNA (●); 6 × SSC at 70°C, high molecular weight DNA (▲); 6 × SSC, 80°C sonicated DNA (○); 6 × SSC at 70°C, sonicated DNA (△).

Quantitative determination

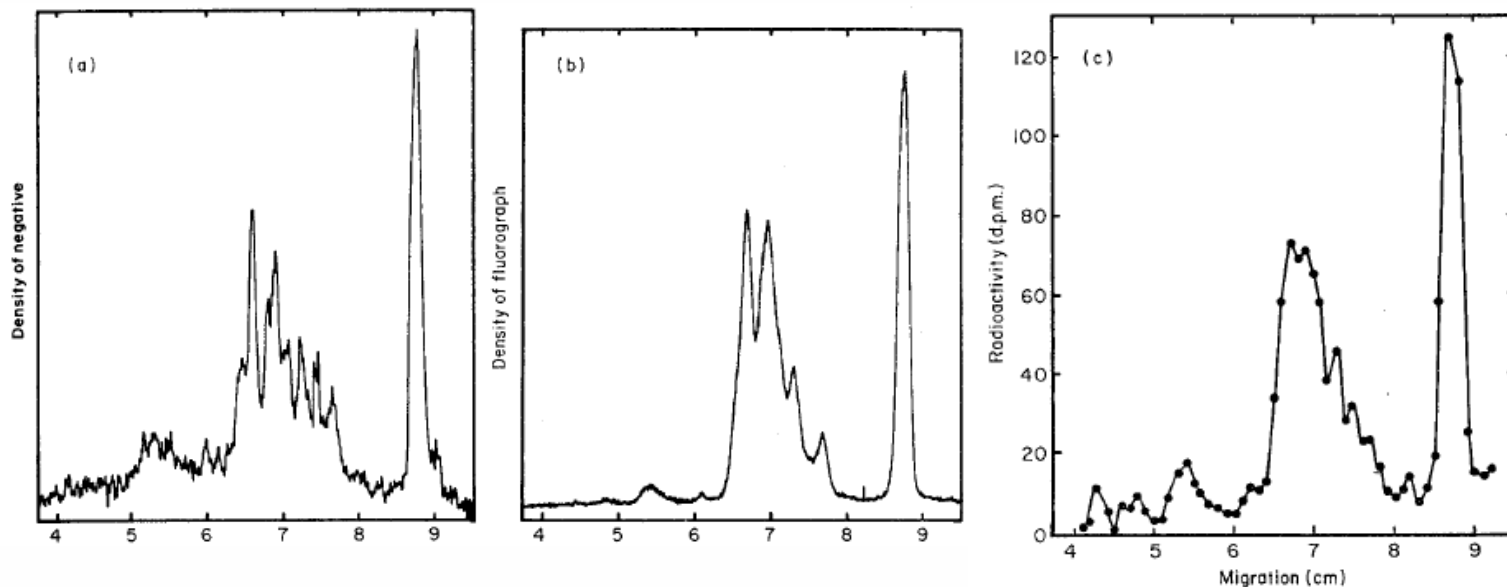

FIG. 7. (a) Microdensitometer tracing of the negative of Plate II(c). (b) Microdensitometer tracing of Plate II(a). (c) Distribution of counts in the Millipore strip which on fluorography gave Plate II(a). The strip was cut into 1 mm pieces, which were counted in a liquid scintillation counter at an efficiency of 40%.

Analysis of Mouse and Rabbit 18S and 28S rDNA

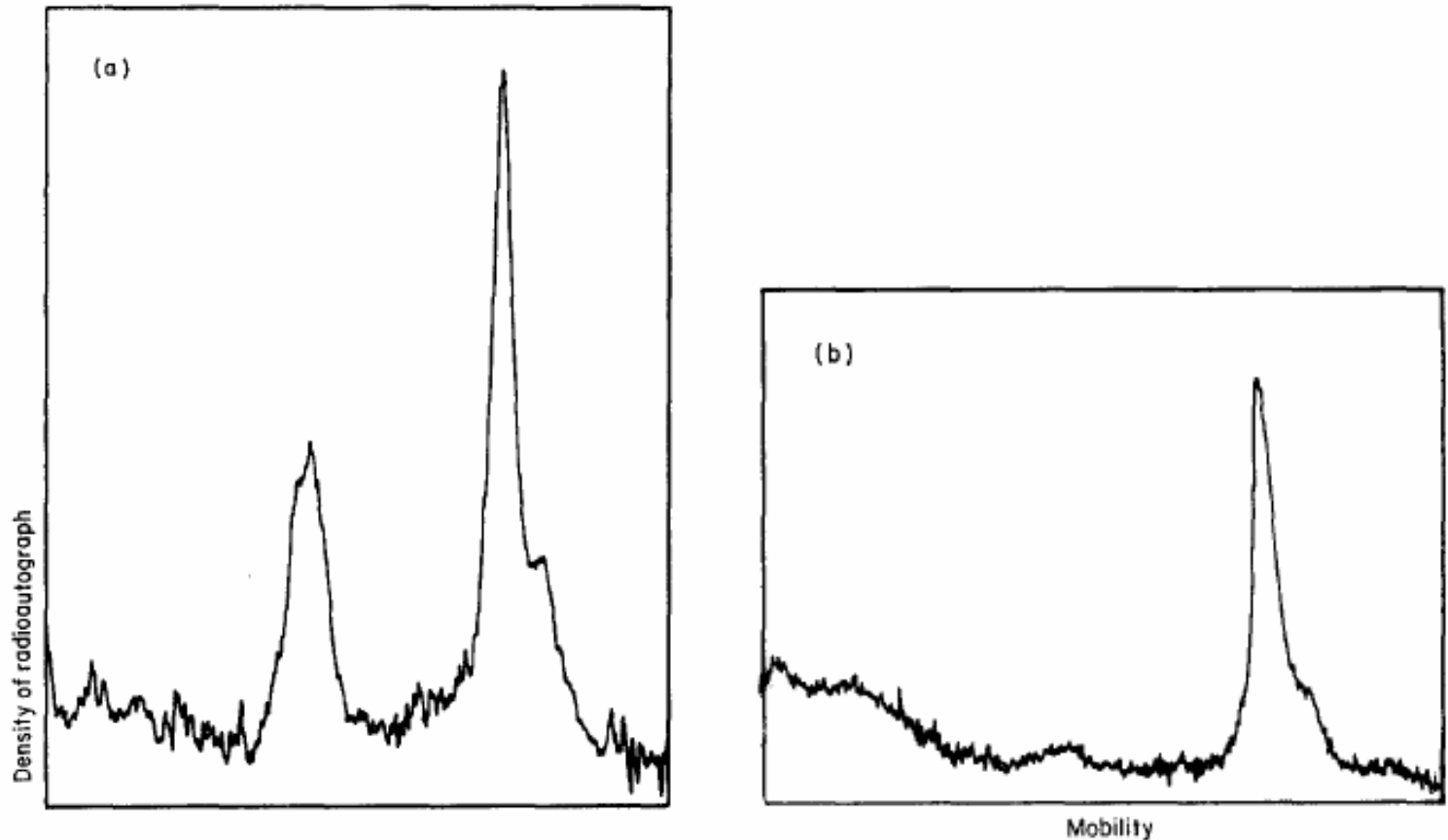

FIG. 8. EcoRI digest of mouse DNA hybridized to 18 S and 28 S RNA.

Total mouse DNA was digested to completion with EcoRI. The digest was separated by electrophoresis on 1% cylindrical agarose gels (9 mm × 24 cm, 5 mA/tube for 20 h, 40 μg of DNA/gel).

The gels were stained, photographed, and the DNA transferred to cellulose nitrate as described in Materials and Methods. One gel was hybridized to ³²P-labelled 18 S RNA and another to 28 S RNA. The RNA concentration was 0.1 μg/ml in 6 × SSC and hybridization was carried out at 80°C for 4 h. The filters were then washed in 2 × SSC (4 l) at 60°C for 30 min, dried and radiographed using Kodak Blue Brand X-ray film.

(a) Densitometer tracing of the 18 S hybrids. (b) Densitometer tracing of the 28 S hybrids.

Analysis of rDNA in five mammals

TABLE 3
Size of EcoRI fragments that hybridize to ribosomal RNAs

Species	Size of RI fragment bearing 28 S sequences ($\times 10^{-6}$)	Size of fragments bearing 18 S sequences ($\times 10^{-6}$)
Calf	5.7	
Human	5.7	
Mouse	5.2	5.2 and approx. 14
Rabbit	6.0	6.0 and approx. 12
Rat	6.0	
<i>X. laevis</i>	3.0	3.0 and 4 to 6

Sizes were estimated from mobilities in 1% agarose gels by comparison with EcoRI fragments of λ -phage DNA. The sizes of the large fragments from mouse and rabbit DNAs hybridizing to 18 S RNA are approximate estimates because there was only one marker in this region of the gel and in this region large differences in size result in small mobility differences.

Conservation of EcoRI sites in the rDNA of mammals.

Albert Lasker Award for Clinical Medical Research '05



“My big contribution to science was the discovery that blotting paper could be used to soak liquid out of jelly. I wouldn't be here today if others had not found clever applications for this simple discovery and I'm delighted to share this prestigious award with Alec Jeffreys who used the method to make the most important discovery that genes have a split structure - the, introns in eukaryotic genes, and he also developed his famous fingerprinting method from it. But there have been others and I get a little bit of credit for each application and as there have been many and colleagues have been generous in their acknowledgement, the credit has mounted up over the years. I hope that anyone who has used the method, learning of this award, will feel that they have earned a share in it. “

- Acceptance remarks by Edwin Southern

-THE END-

