

Satisfiability of Propositional Formulas

Mooly Sagiv

Slides by Sharad Malik, Ohad Shacham, Daniel Kroening and Ofer Strichman

The SAT Problem

- Given a propositional formula (Boolean function)
 - $\varphi = (\mathbf{a} \vee \mathbf{b}) \wedge (\neg \mathbf{a} \vee \neg \mathbf{b} \vee \mathbf{c})$
- Determine if φ is valid
- Determine if φ is satisfiable
 - Find a satisfying assignment or report that such does not exist
- For n variables, there are 2^n possible truth assignments to be checked

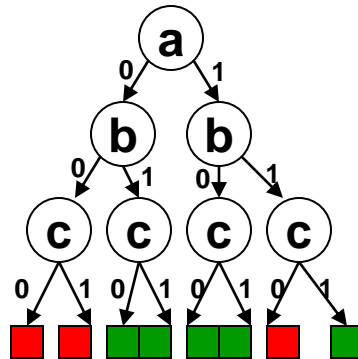

Why Bother?

- Core computational engine for major applications
 - Artificial Intelligence
 - Knowledge base deduction
 - Automatic theorem proving
 - Electronic Design Automaton
 - Testing and Verification
 - Logic synthesis
 - FPGA routing
 - Path delay analysis
 - And more...
 - Software Verification

Problem Representation

- Represent the formulas in Conjunctive Normal Form (CNF)
- Conversion to CNF is straightforward
 - $\mathbf{a \vee (b \wedge \neg(c \vee \neg d)) \equiv (a \vee (b \wedge \neg c \wedge \neg\neg d)) \equiv (a \vee (b \wedge \neg c \wedge d)) \equiv (a \vee b) \wedge (a \vee \neg c) \wedge (a \vee d)}$
 - **May need to add variables**
- Notations
 - Literals
 - Variable or its negation
 - Clauses
 - Disjunction of literals
 - $\mathbf{\varphi = (a \vee b) \wedge (\neg a \vee \neg b \vee c) \equiv (a + b)(a' + b' + c)}$
- Advantages of CNF
 - Simple data structure
 - Compact
 - Compositional
 - All the clauses need to be satisfied

Complexity Results

- First established NP-Complete problem
 - Even when at most 3 literals per clause (3-SAT)
 - S. A. Cook, The complexity of theorem proving procedures, *Proceedings, Third Annual ACM Symp. on the Theory of Computing*, 1971, 151-158
 - No polynomial algorithm for all instances unless $P = NP$
- Becomes polynomial when
 - At most two literals per clause (2-SAT)
 - At most one positive literal in every clause (Horn)

Goals

- Develop algorithms which solve all SAT instances
- Exponential worst case complexity
- But works well on many instances
 - Interesting Heuristics
 - Annual SAT conferences
 - SAT competitions
 - Randomly, Handmade, Industrial, AI
 - 10 Millions variables!

SAT made some progress...

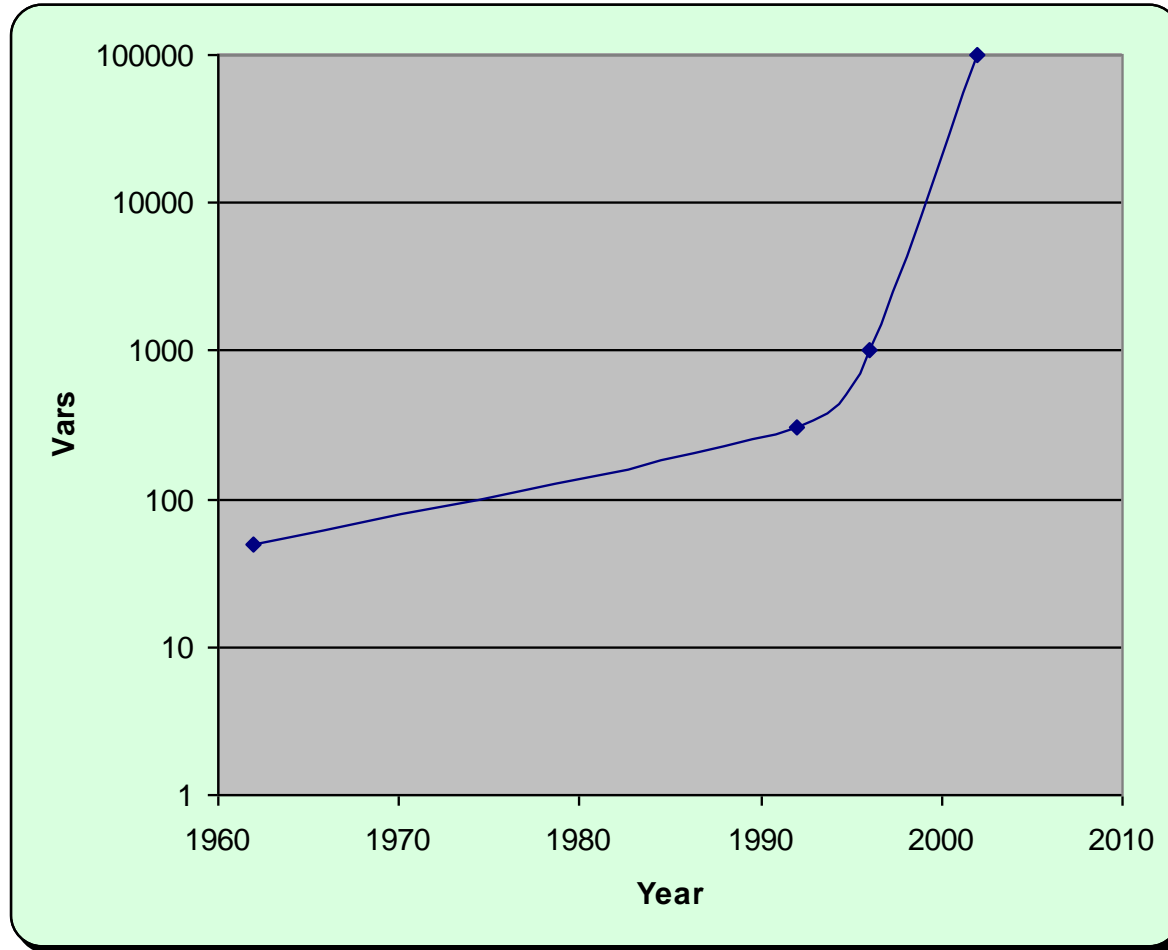

Clause Resolution

- Resolution of a pair of clauses with exactly ONE incompatible variable

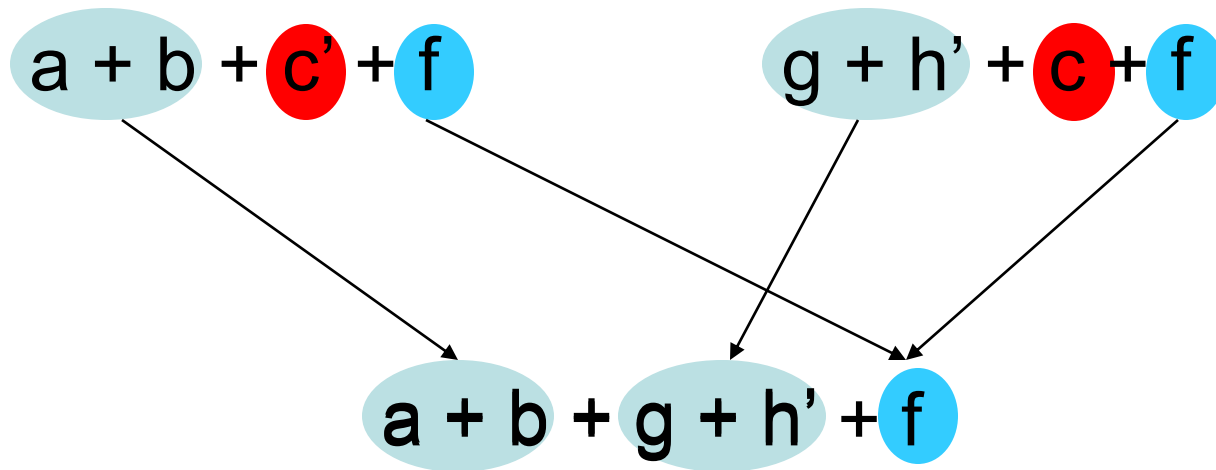

- What if more than one incompatible variables?

Davis Putnam Algorithm

M .Davis, H. Putnam, "A computing procedure for quantification theory", *J. of ACM*, Vol. 7, pp. 201-214, 1960

- Iteratively select a variable for resolution till no more variables are left
- Report UNSAT when the empty clause occurs
- Can discard resolved clauses after each iteration

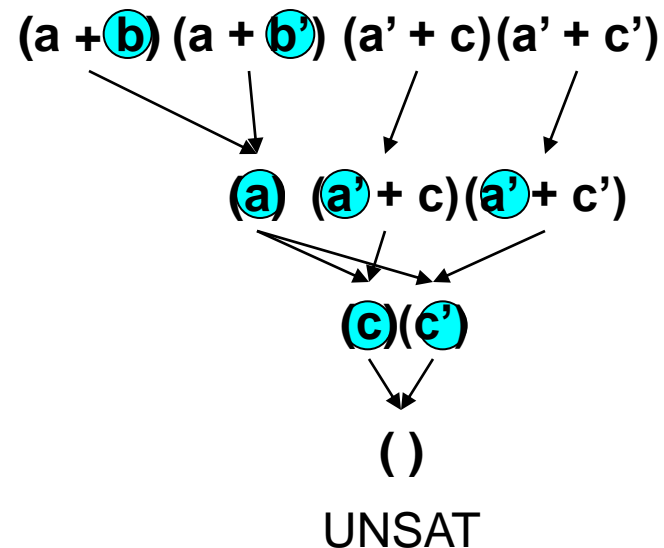
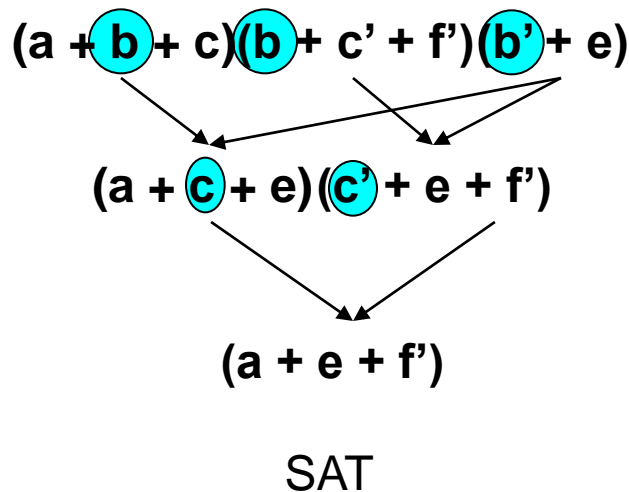

Potential memory explosion problem!

Can we avoid using exponential space?

DLL Algorithm

- Davis, Logemann and Loveland

M. Davis, G. Logemann and D. Loveland, "A Machine Program for Theorem-Proving", *Communications of ACM*, Vol. 5, No. 7, pp. 394-397, 1962

- Basic framework for many modern SAT solvers
- Also known as DPLL for historical reasons

Basic DLL Procedure - DFS

(a' + b + c)

(a + c + d)

(a + c + d')

(a + c' + d)

(a + c' + d')

(b' + c' + d)

(a' + b + c')

(a' + b' + c)

Basic DLL Procedure - DFS

$(a' + b + c)$

$(a + c + d)$

$(a + c + d')$

$(a + c' + d)$

$(a + c' + d')$

$(b' + c' + d)$

$(a' + b + c')$

$(a' + b' + c)$

a

Basic DLL Procedure - DFS

$(a' + b + c)$

$(a + c + d)$

$(a + c + d')$

$(a + c' + d)$

$(a + c' + d')$

$(b' + c' + d)$

$(a' + b + c')$

$(a' + b' + c)$

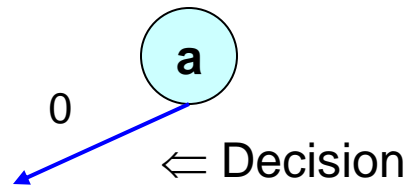

Basic DLL Procedure - DFS

$(a' + b + c)$

$(a + c + d)$

$(a + c + d')$

$(a + c' + d)$

$(a + c' + d')$

$(b' + c' + d)$

$(a' + b + c')$

$(a' + b' + c)$

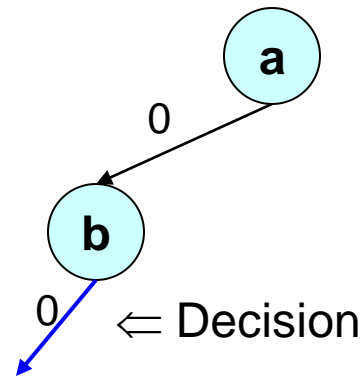

Basic DLL Procedure - DFS

$(a' + b + c)$
 $(a + c + d)$
 $(a + c + d')$
 $(a + c' + d)$
 $(a + c' + d')$
 $(b' + c' + d)$
 $(a' + b + c')$
 $(a' + b' + c)$

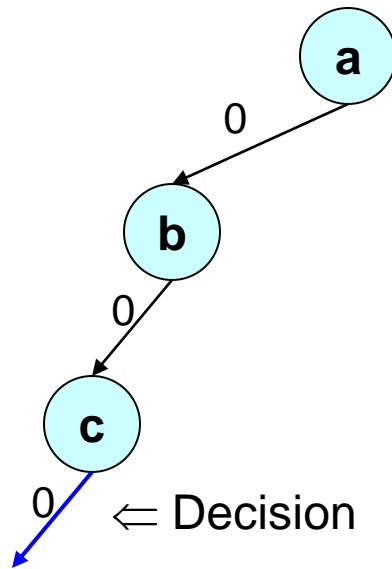

Basic DLL Procedure - DFS

$(a' + b + c)$
 $(a + c + d)$
 $(a + c + d')$
 $(a + c' + d)$
 $(a + c' + d')$
 $(b' + c' + d)$
 $(a' + b + c')$
 $(a' + b' + c)$

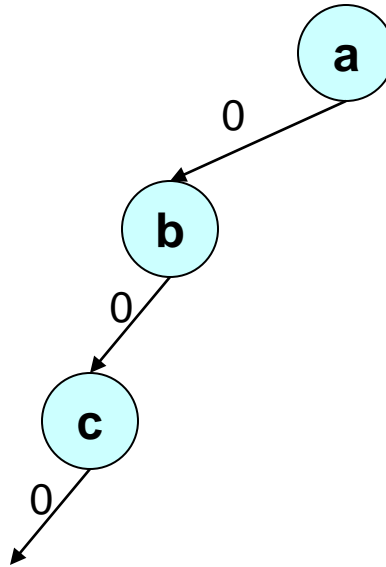

Implication Graph

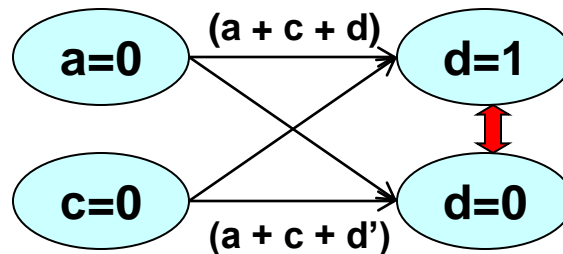

Conflict!

Basic DLL Procedure - DFS

- $(a' + b + c)$
- $(a + c + d)$
- $(a + c + d')$
- $(a + c' + d)$
- $(a + c' + d')$
- $(b' + c' + d)$
- $(a' + b + c')$
- $(a' + b' + c)$

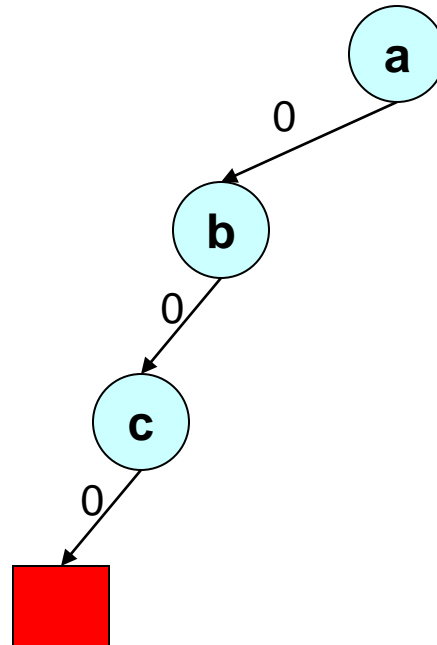

Implication Graph

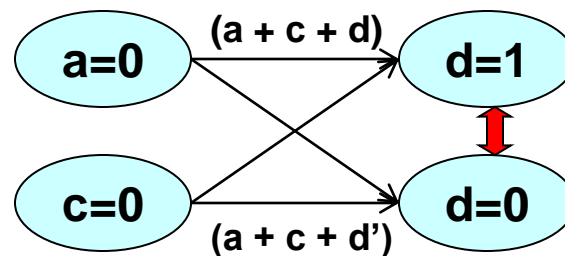

Conflict!

Basic DLL Procedure - DFS

$(a' + b + c)$

$(a + c + d)$

$(a + c + d')$

$(a + c' + d)$

$(a + c' + d')$

$(b' + c' + d)$

$(a' + b + c')$

$(a' + b' + c)$

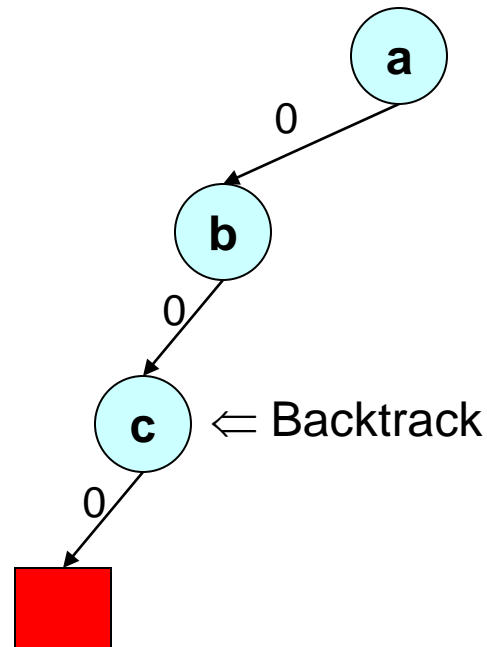

Basic DLL Procedure - DFS

$(a' + b + c)$
 $(a + c + d)$
 $(a + c + d')$
 $(a + c' + d)$
 $(a + c' + d')$
 $(b' + c' + d)$
 $(a' + b + c')$
 $(a' + b' + c)$

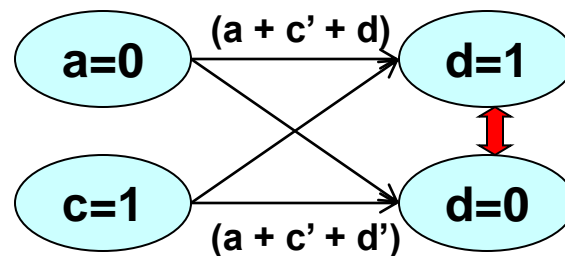
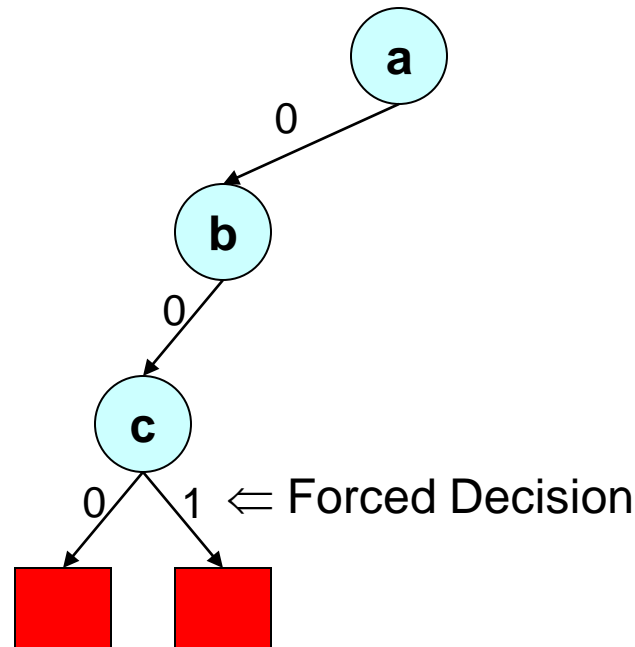

Basic DLL Procedure - DFS

$(a' + b + c)$

$(a + c + d)$

$(a + c + d')$

$(a + c' + d)$

$(a + c' + d')$

$(b' + c' + d)$

$(a' + b + c')$

$(a' + b' + c)$

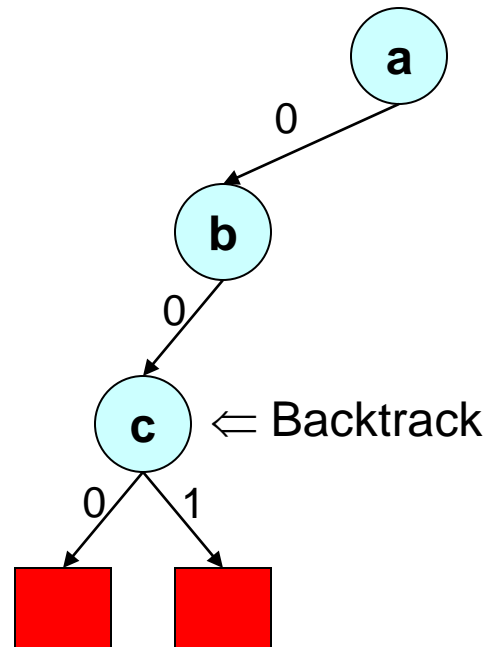

Basic DLL Procedure - DFS

$(a' + b + c)$

$(a + c + d)$

$(a + c + d')$

$(a + c' + d)$

$(a + c' + d')$

$(b' + c' + d)$

$(a' + b + c')$

$(a' + b' + c)$

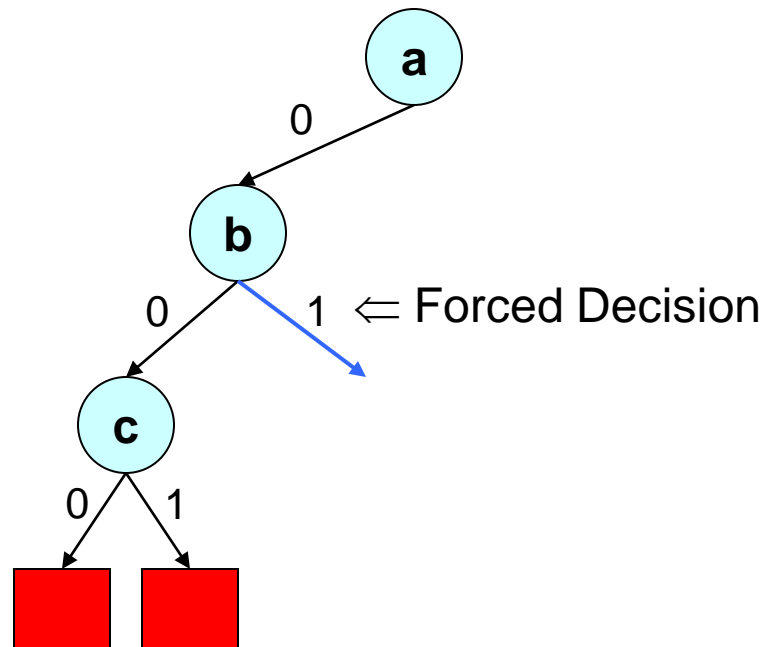

Basic DLL Procedure - DFS

$(a' + b + c)$
 $(a + c + d)$
 $(a + c + d')$
 $(a + c' + d)$
 $(a + c' + d')$
 $(b' + c' + d)$
 $(a' + b + c')$
 $(a' + b' + c)$

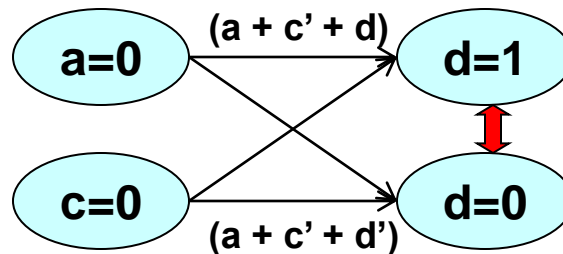
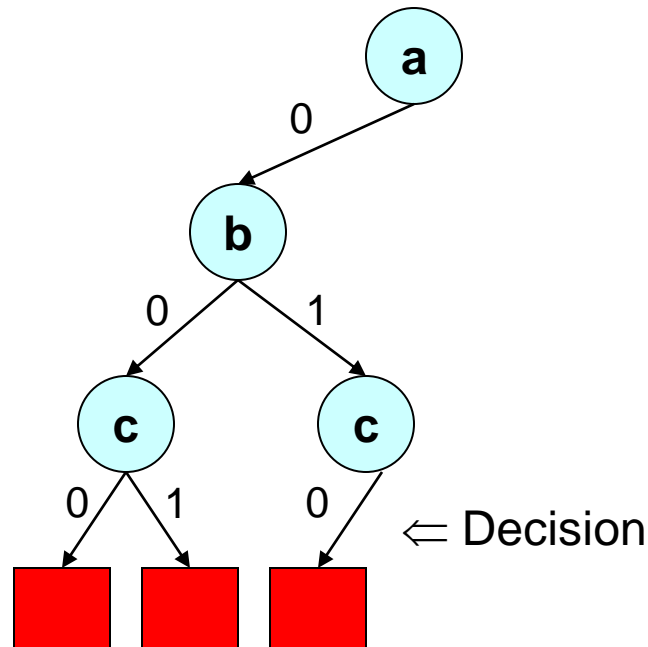

Basic DLL Procedure - DFS

$(a' + b + c)$

$(a + c + d)$

$(a + c + d')$

$(a + c' + d)$

$(a + c' + d')$

$(b' + c' + d)$

$(a' + b + c')$

$(a' + b' + c)$

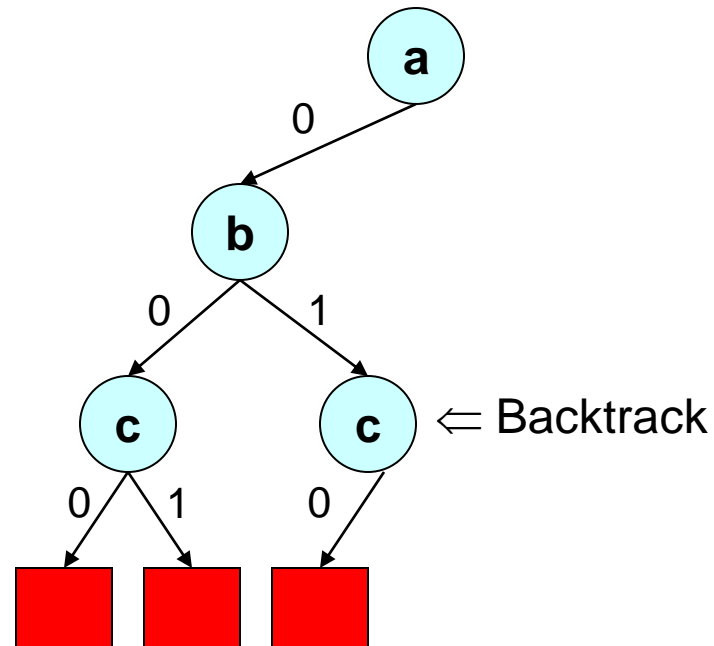

Basic DLL Procedure - DFS

$(a' + b + c)$
 $(a + c + d)$
 $(a + c + d')$
 $(a + c' + d)$
 $(a + c' + d')$
 $(b' + c' + d)$
 $(a' + b + c')$
 $(a' + b' + c)$

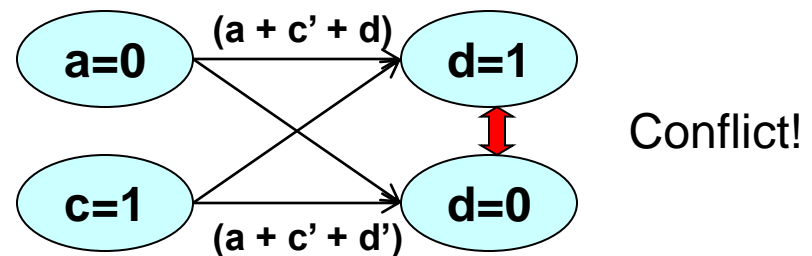
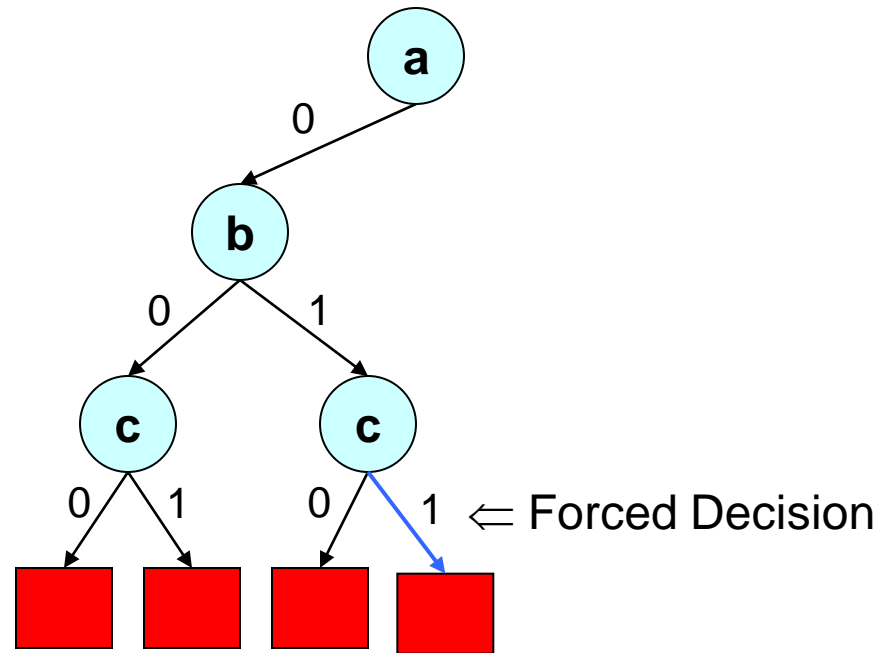

Basic DLL Procedure - DFS

$(a' + b + c)$

$(a + c + d)$

$(a + c + d')$

$(a + c' + d)$

$(a + c' + d')$

$(b' + c' + d)$

$(a' + b + c')$

$(a' + b' + c)$

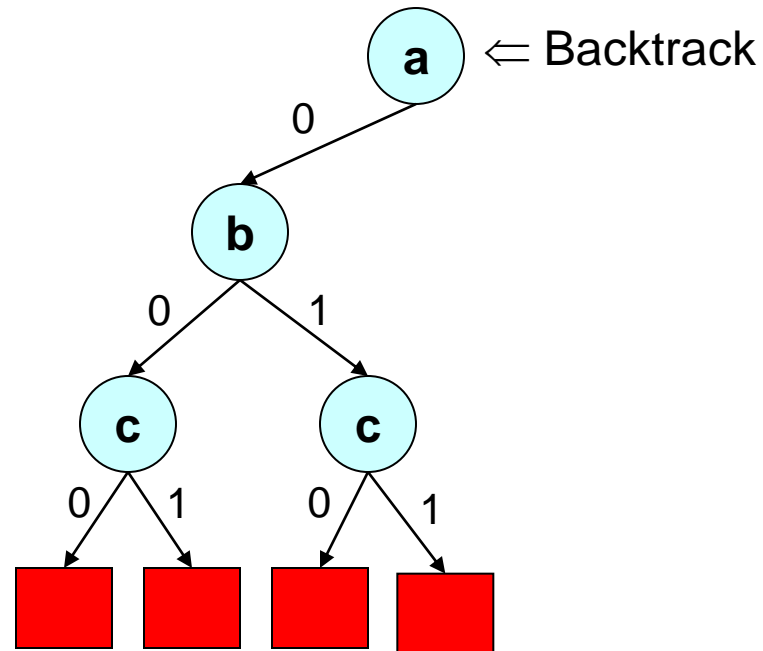

Basic DLL Procedure - DFS

$(a' + b + c)$

$(a + c + d)$

$(a + c + d')$

$(a + c' + d)$

$(a + c' + d')$

$(b' + c' + d)$

$(a' + b + c')$

$(a' + b' + c)$

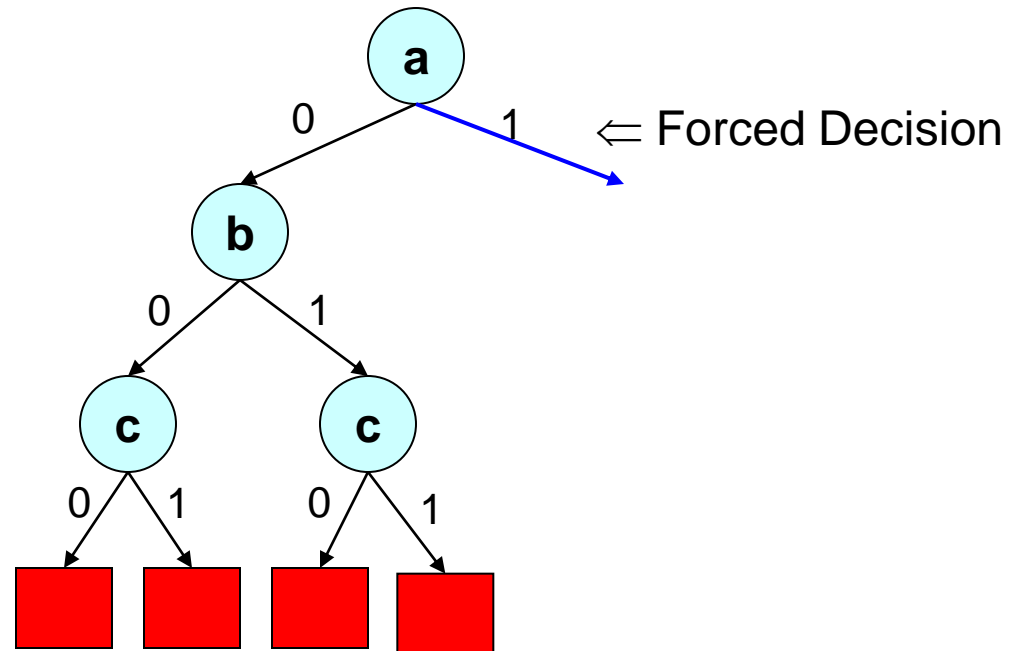

Basic DLL Procedure - DFS

$(a' + b + c)$

$(a + c + d)$

$(a + c + d')$

$(a + c' + d)$

$(a + c' + d')$

$(b' + c' + d)$

$(a' + b + c')$

$(a' + b' + c)$

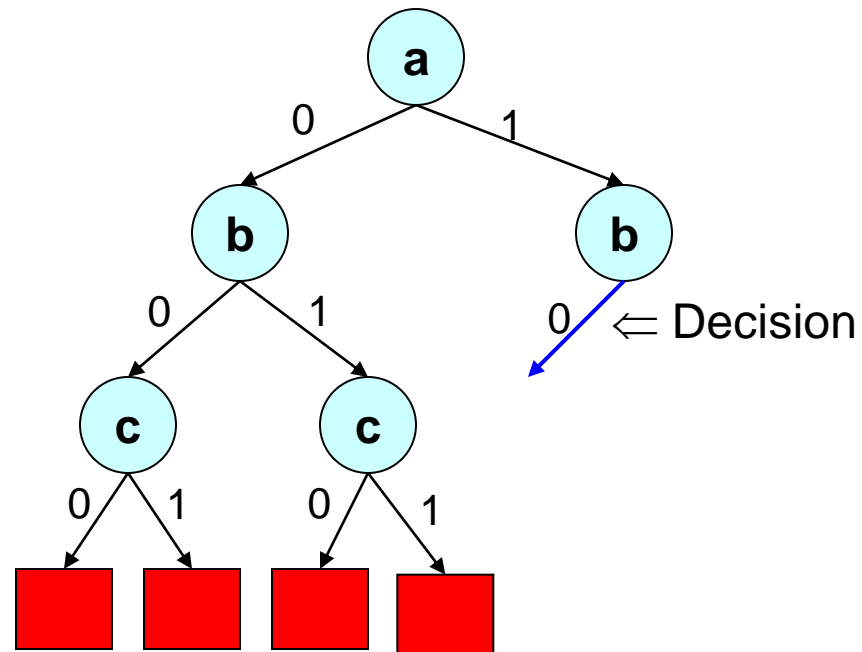

Basic DLL Procedure - DFS

$(a' + b + c)$
 $(a + c + d)$
 $(a + c + d')$
 $(a + c' + d)$
 $(a + c' + d')$
 $(b' + c' + d)$
 $(a' + b + c')$
 $(a' + b' + c)$

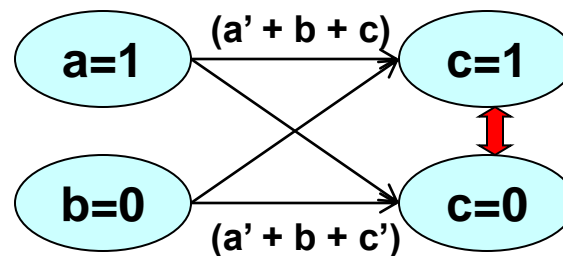
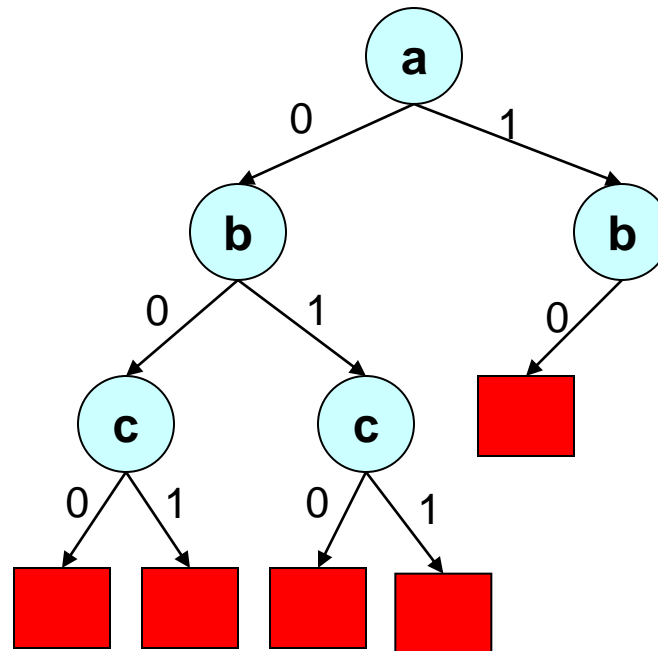

Conflict!

Basic DLL Procedure - DFS

$(a' + b + c)$

$(a + c + d)$

$(a + c + d')$

$(a + c' + d)$

$(a + c' + d')$

$(b' + c' + d)$

$(a' + b + c')$

$(a' + b' + c)$

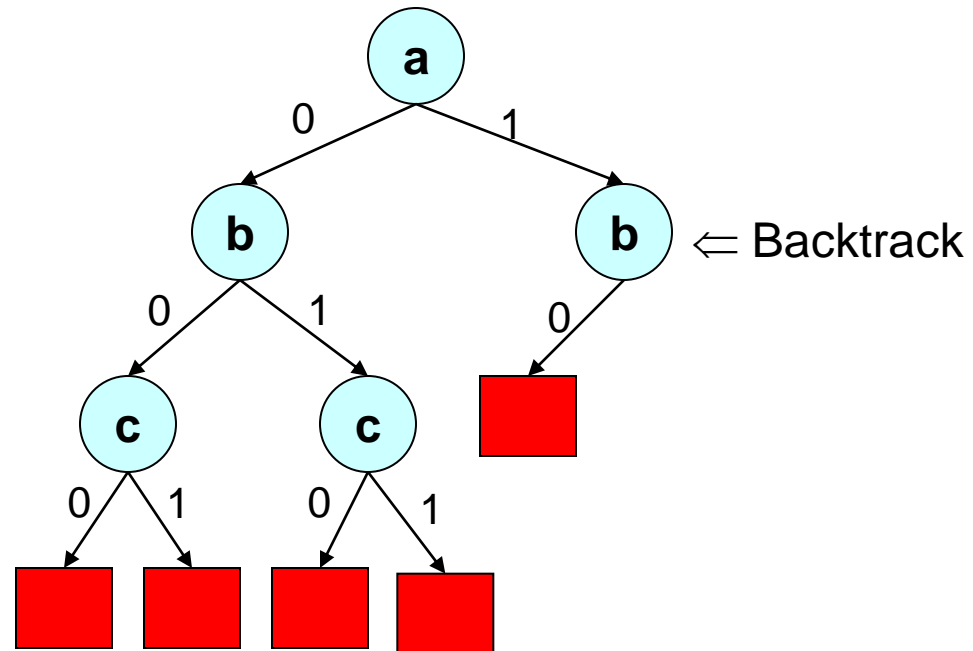

Basic DLL Procedure - DFS

$(a' + b + c)$
 $(a + c + d)$
 $(a + c + d')$
 $(a + c' + d)$
 $(a + c' + d')$
 $(b' + c' + d)$
 $(a' + b + c')$
 $(a' + b' + c)$

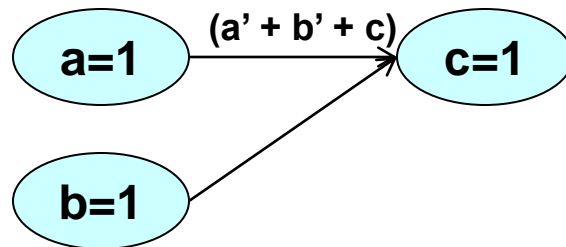
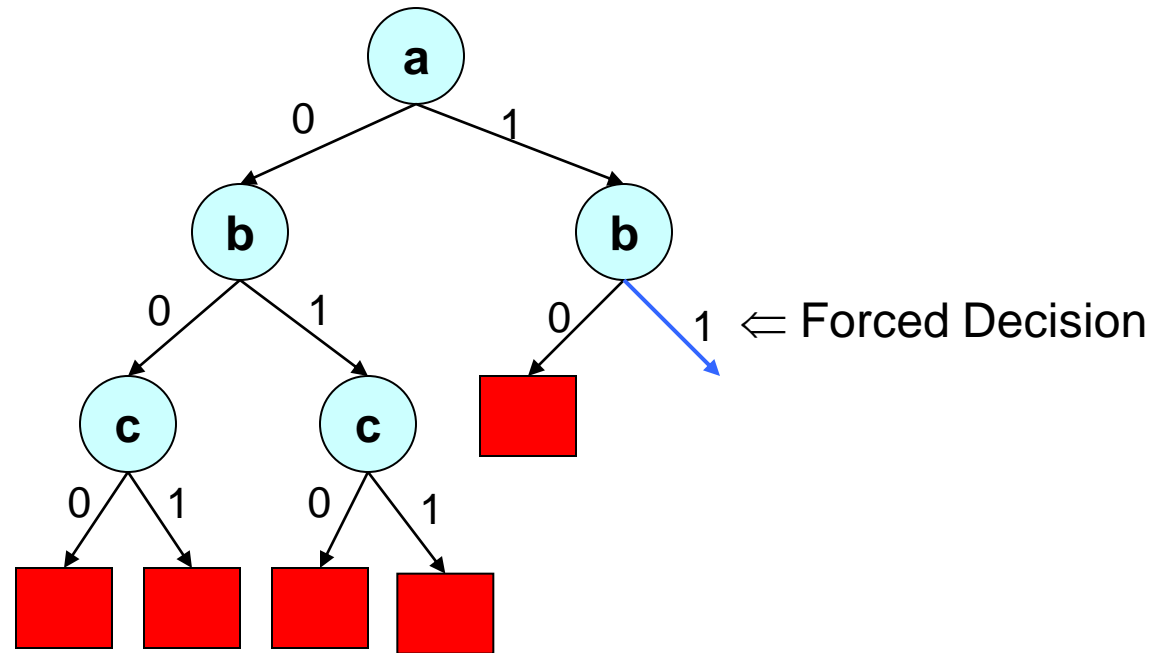

Basic DLL Procedure - DFS

$(a' + b + c)$
 $(a + c + d)$
 $(a + c + d')$
 $(a + c' + d)$
 $(a + c' + d')$
 $(b' + c' + d)$
 $(a' + b + c')$
 $(a' + b' + c)$

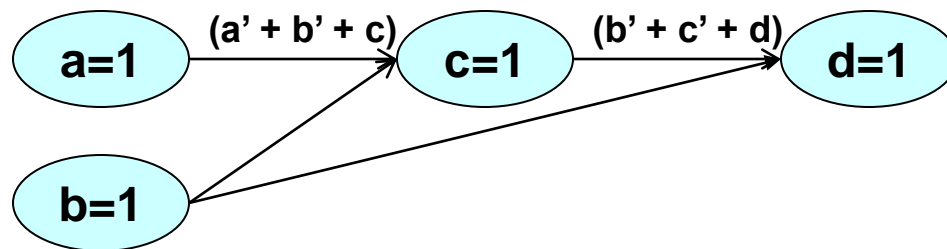
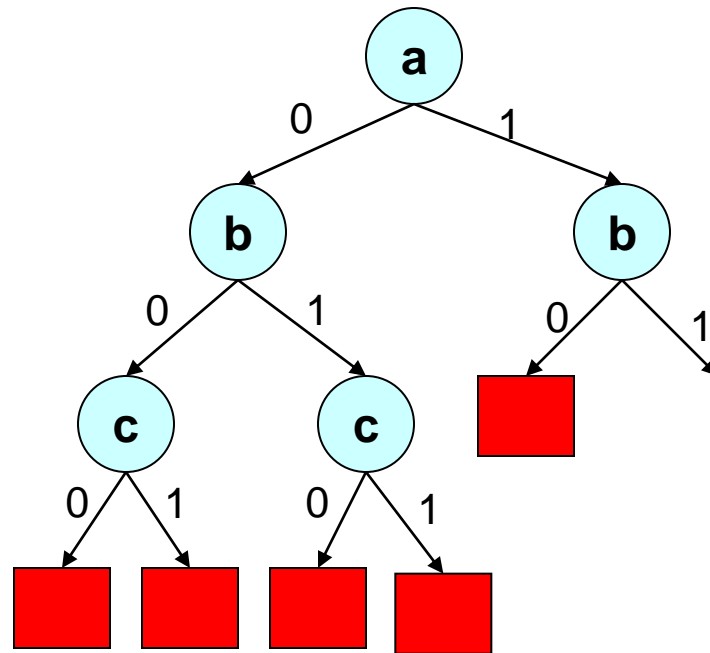

Basic DLL Procedure - DFS

$(a' + b + c)$
 $(a + c + d)$
 $(a + c + d')$
 $(a + c' + d)$
 $(a + c' + d')$
 $(b' + c' + d)$
 $(a' + b + c')$
 $(a' + b' + c)$

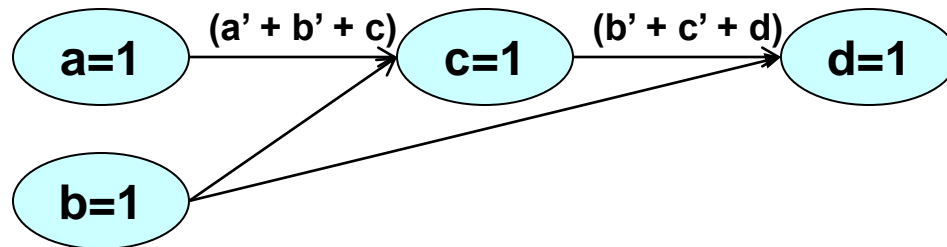
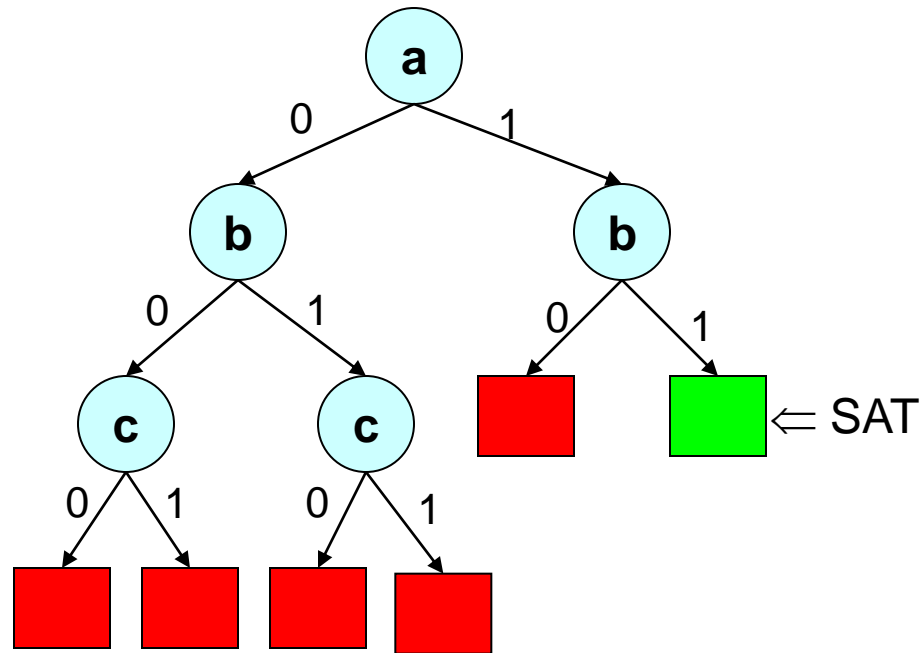

Implications and Boolean Constraint Propagation

- Implication
 - A variable is forced to be assigned to be True or False based on previous assignments
- **Unit** clause rule (rule for elimination of one literal clauses)
 - An unsatisfied clause is a unit clause if it has exactly one unassigned literal

$$(a + b' + c)(b + c')(a' + c')$$

$$a = T, b = T, c \text{ is unassigned}$$

Satisfied Literal

Unsatisfied Literal

Unassigned Literal

- The unassigned literal is implied because of the unit clause
- Boolean Constraint Propagation (BCP)
 - Iteratively apply the unit clause rule until there is no unit clause available
- Workhorse of DLL based algorithms

A Basic SAT algorithm

```
While (true)
{
  if (!Decide()) return (SAT)
  while (!BCP())
  if (!Resolve_Conflict()) return (UNSAT)
}
```

Choose the next variable and value.
Return False if all variables are assigned

Apply repeatedly the *unit clause rule*.
Return False if reached a conflict

Backtrack until no conflict.
Return False if impossible

Conflict Driven Learning and Non-chronological Backtracking

$$x1 + x4$$

$$x1 + x3' + x8'$$

$$x1 + x8 + x12$$

$$x2 + x11$$

$$x7' + x3' + x9$$

$$x7' + x8 + x9'$$

$$x7 + x8 + x10'$$

$$x7 + x10 + x12'$$

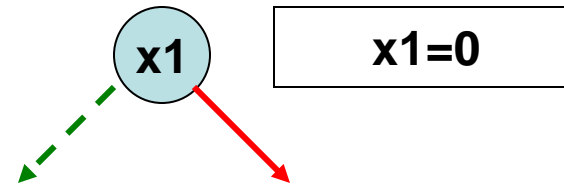

$$\text{○ } x1=0$$

Conflict Driven Learning and Non-chronological Backtracking

$$x1 + x4$$

$$x1 + x3' + x8'$$

$$x1 + x8 + x12$$

$$x2 + x11$$

$$x7' + x3' + x9$$

$$x7' + x8 + x9'$$

$$x7 + x8 + x10'$$

$$x7 + x10 + x12'$$

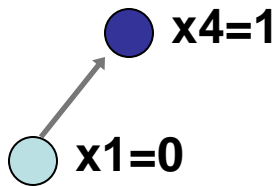
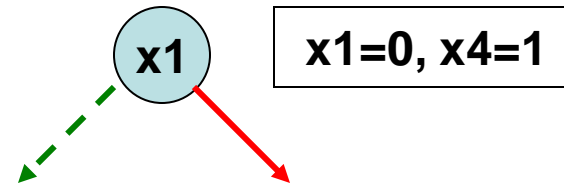

Conflict Driven Learning and Non-chronological Backtracking

x1 + x4

x1 + x3' + x8'

x1 + x8 + x12

x2 + x11

x7' + x3' + x9

x7' + x8 + x9'

x7 + x8 + x10'

x7 + x10 + x12'

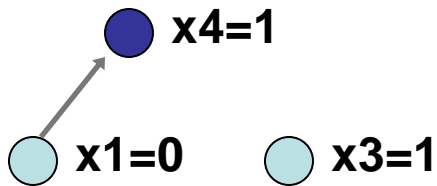
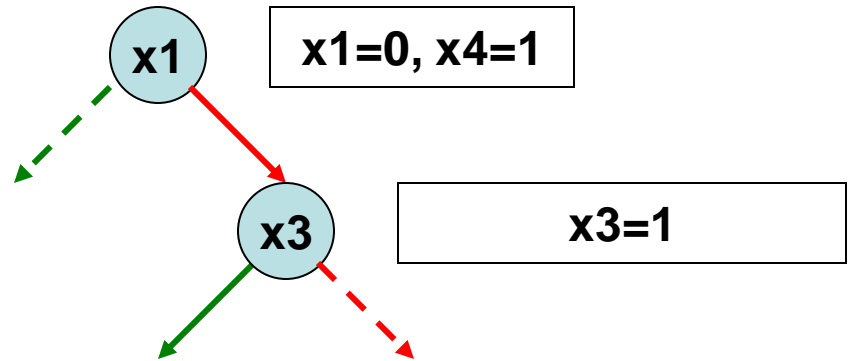

Conflict Driven Learning and Non-chronological Backtracking

$x_1 + x_4$

$x_1 + x_3' + x_8'$

$x_1 + x_8 + x_{12}$

$x_2 + x_{11}$

$x_7' + x_3' + x_9$

$x_7' + x_8 + x_9'$

$x_7 + x_8 + x_{10}'$

$x_7 + x_{10} + x_{12}'$

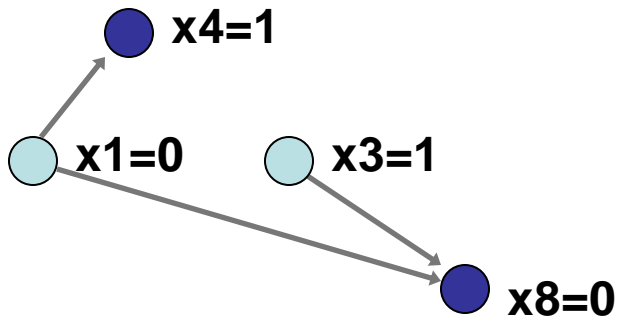
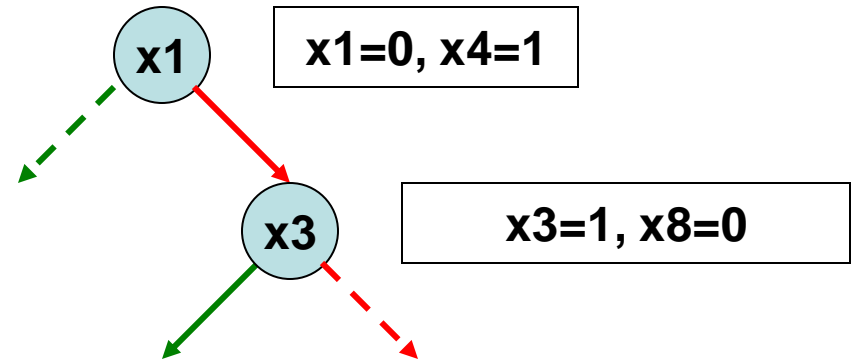

Conflict Driven Learning and Non-chronological Backtracking

$x_1 + x_4$

$x_1 + x_3' + x_8'$

$x_1 + x_8 + x_{12}$

$x_2 + x_{11}$

$x_7' + x_3' + x_9$

$x_7' + x_8 + x_9'$

$x_7 + x_8 + x_{10}'$

$x_7 + x_{10} + x_{12}'$

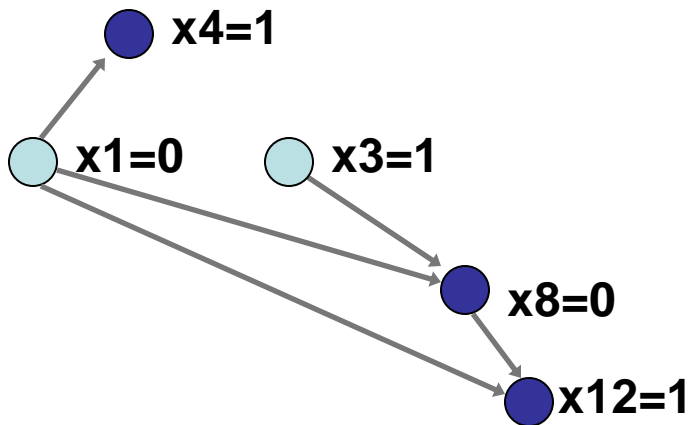
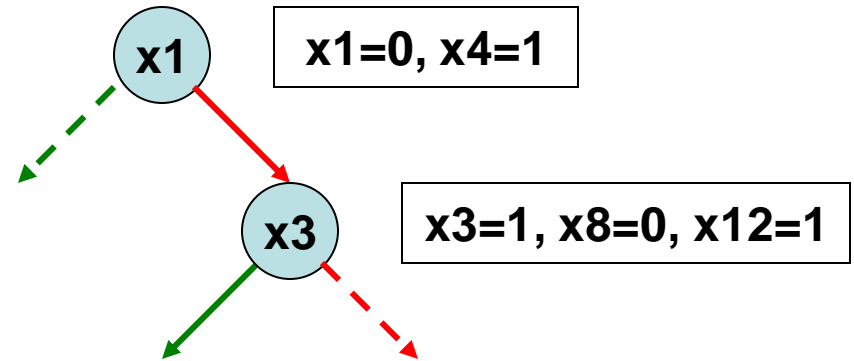

Conflict Driven Learning and Non-chronological Backtracking

$x_1 + x_4$

$x_1 + x_3' + x_8'$

$x_1 + x_8 + x_{12}$

$x_2 + x_{11}$

$x_7' + x_3' + x_9$

$x_7' + x_8 + x_9'$

$x_7 + x_8 + x_{10}'$

$x_7 + x_{10} + x_{12}'$

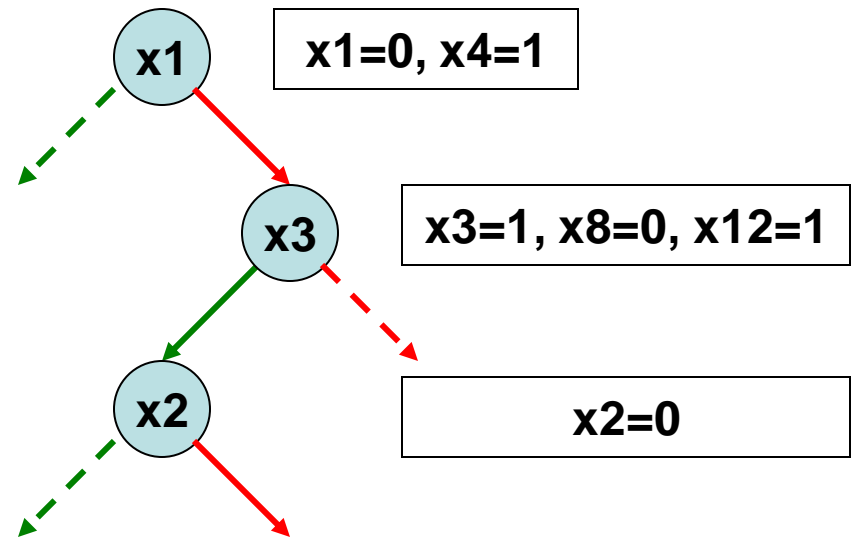
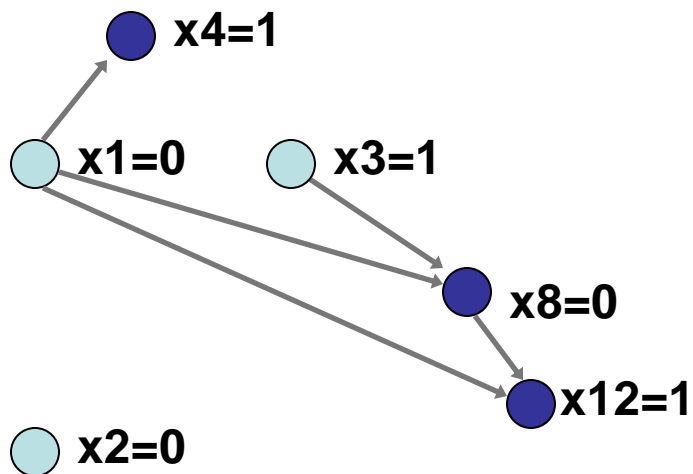

Conflict Driven Learning and Non-chronological Backtracking

$$x1 + x4$$

$$x1 + x3' + x8'$$

$$x1 + x8 + x12$$

$$x2 + x11$$

$$x7' + x3' + x9$$

$$x7' + x8 + x9'$$

$$x7 + x8 + x10'$$

$$x7 + x10 + x12'$$

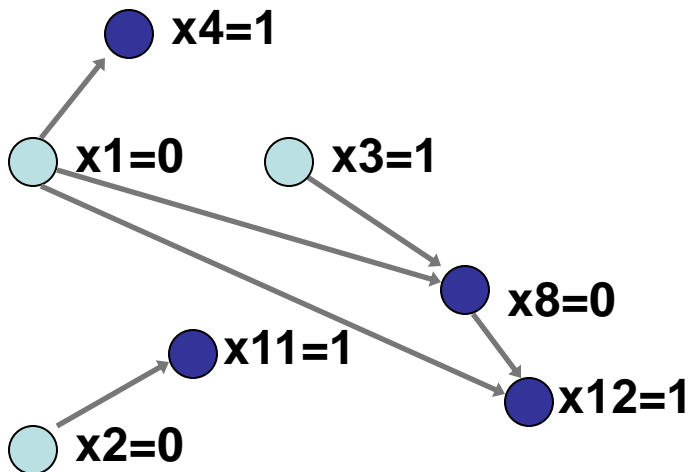
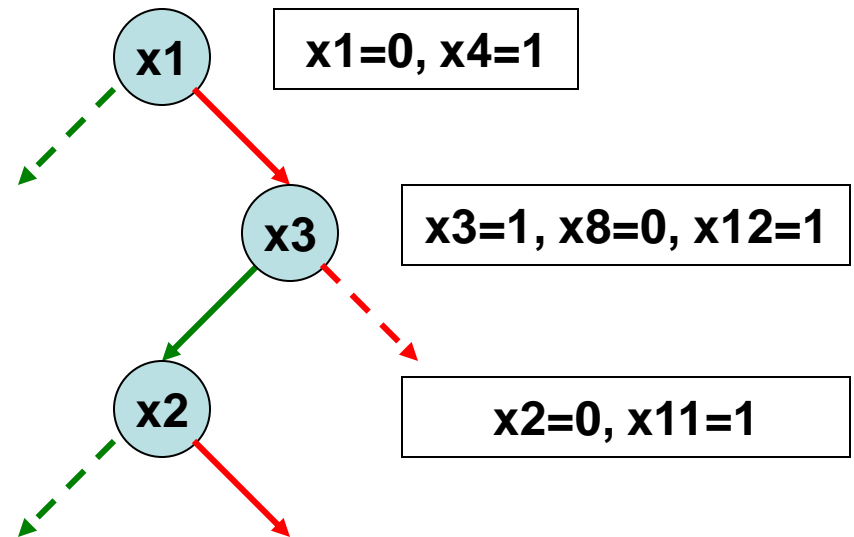

Conflict Driven Learning and Non-chronological Backtracking

$$x1 + x4$$

$$x1 + x3' + x8'$$

$$x1 + x8 + x12$$

$$x2 + x11$$

$$x7' + x3' + x9$$

$$x7' + x8 + x9'$$

$$x7 + x8 + x10'$$

$$x7 + x10 + x12'$$

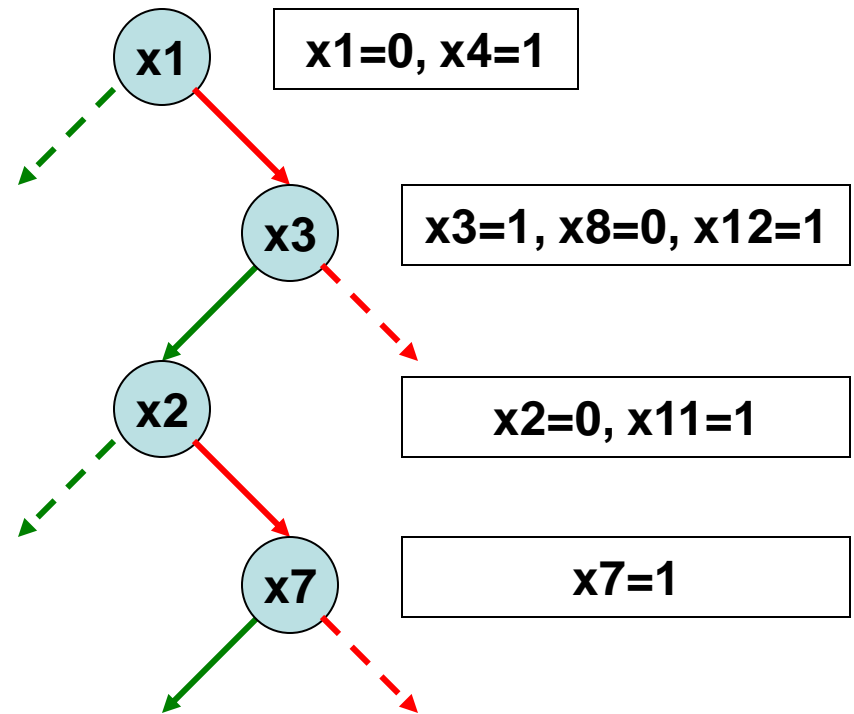
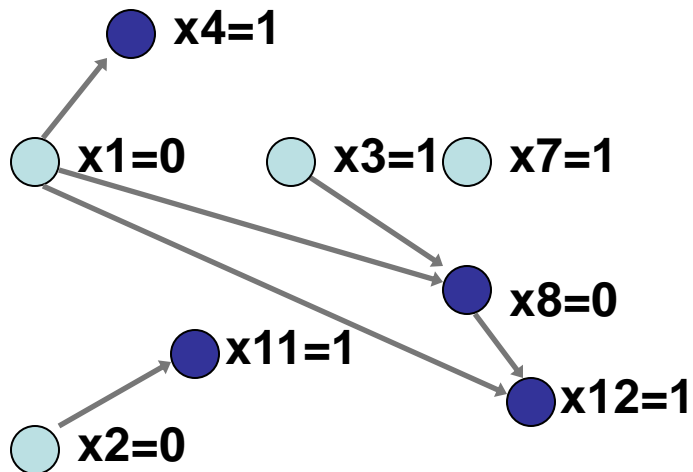

Conflict Driven Learning and Non-chronological Backtracking

$x_1 + x_4$

$x_1 + x_3' + x_8'$

$x_1 + x_8 + x_{12}$

$x_2 + x_{11}$

$x_7' + x_3' + x_9$

$x_7' + x_8 + x_9'$

$x_7 + x_8 + x_{10}'$

$x_7 + x_{10} + x_{12}'$

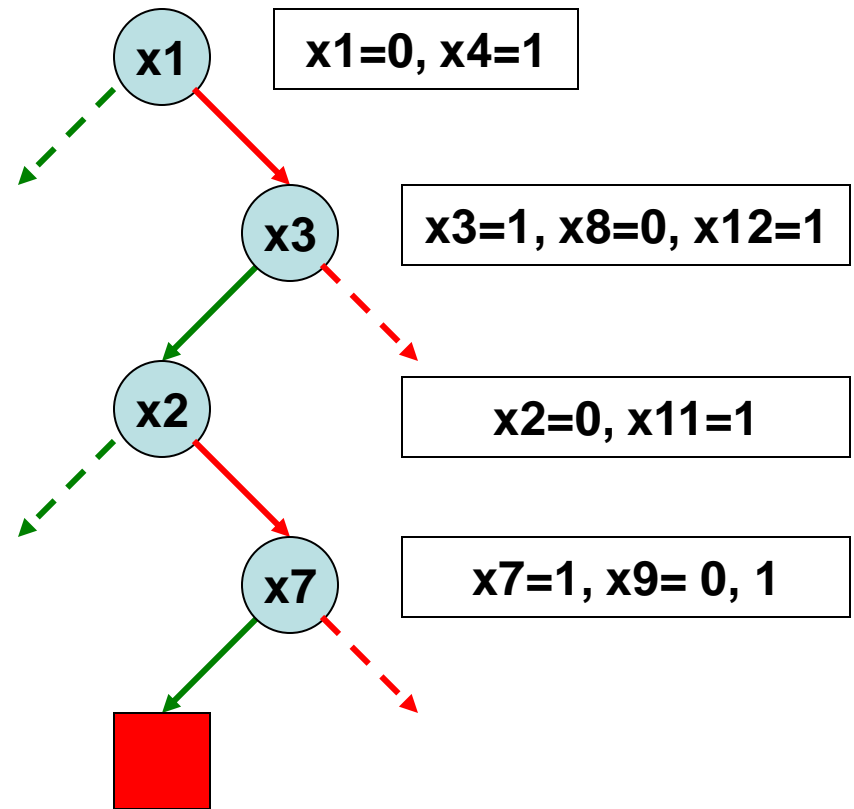
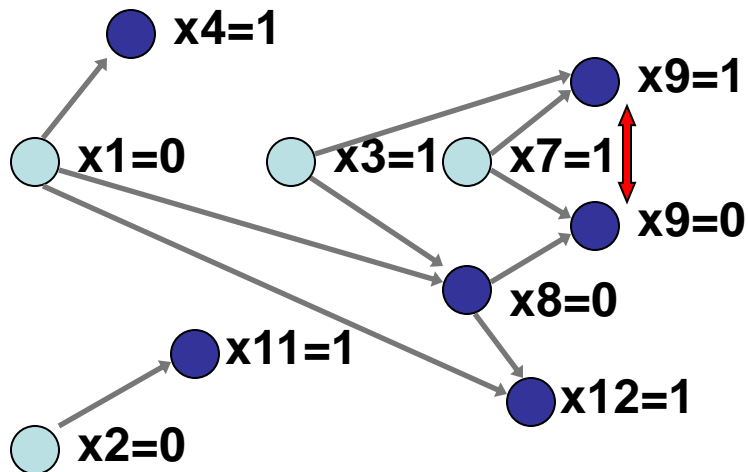

Conflict Driven Learning and Non-chronological Backtracking

$x_1 + x_4$

$x_1 + x_3' + x_8'$

$x_1 + x_8 + x_{12}$

$x_2 + x_{11}$

$x_7' + x_3' + x_9$

$x_7' + x_8 + x_9'$

$x_7 + x_8 + x_{10}'$

$x_7 + x_{10} + x_{12}'$

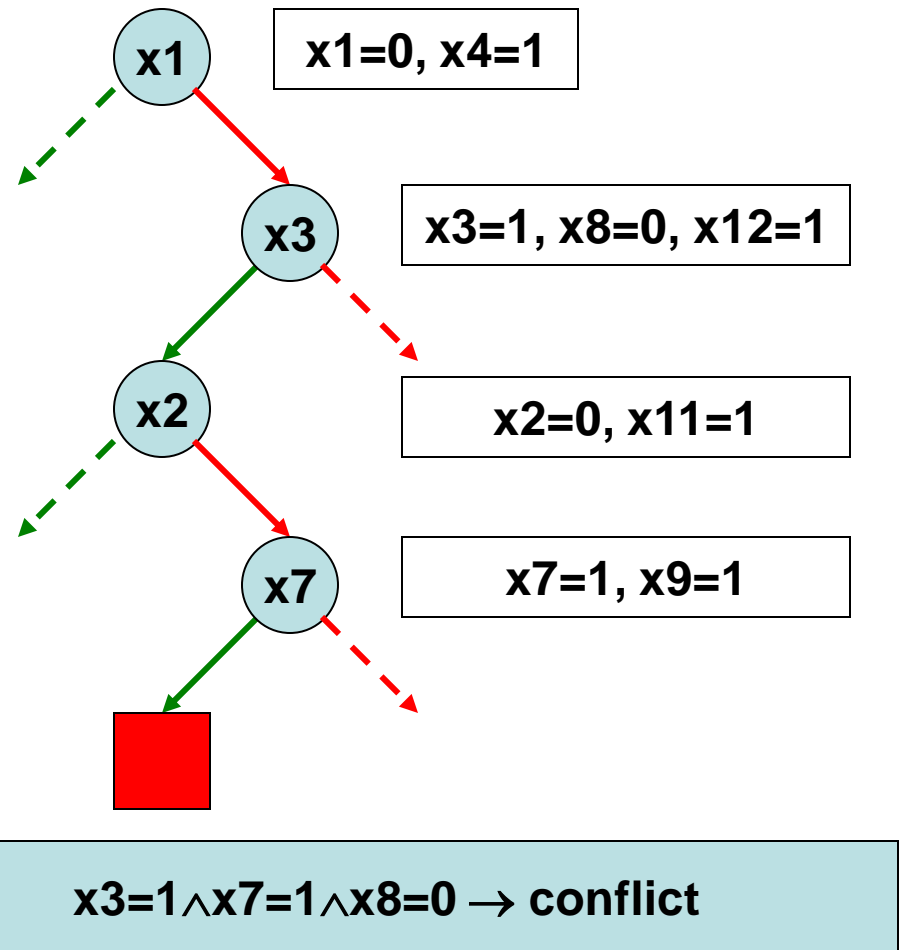
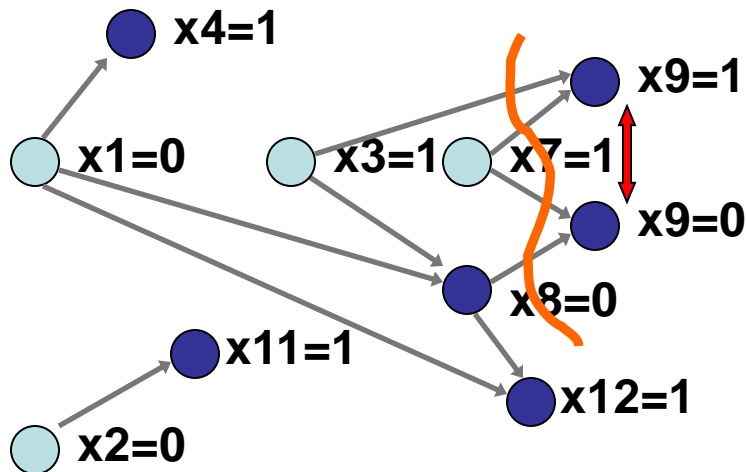

Conflict Driven Learning and Non-chronological Backtracking

$x_1 + x_4$

$x_1 + x_3' + x_8'$

$x_1 + x_8 + x_{12}$

$x_2 + x_{11}$

$x_7' + x_3' + x_9$

$x_7' + x_8 + x_9'$

$x_7 + x_8 + x_{10}'$

$x_7 + x_{10} + x_{12}'$

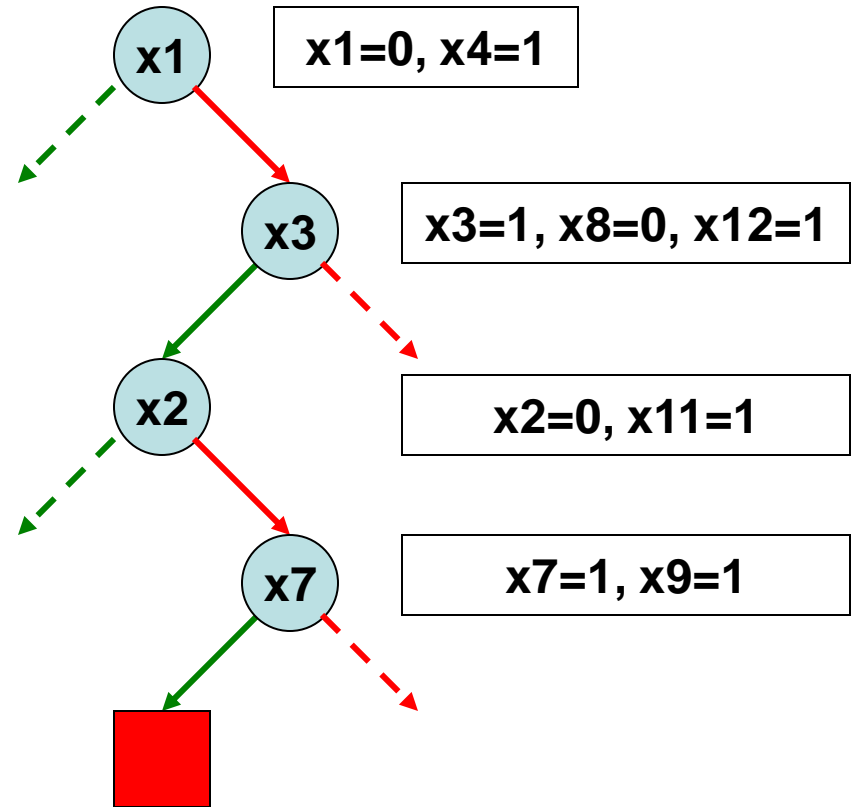
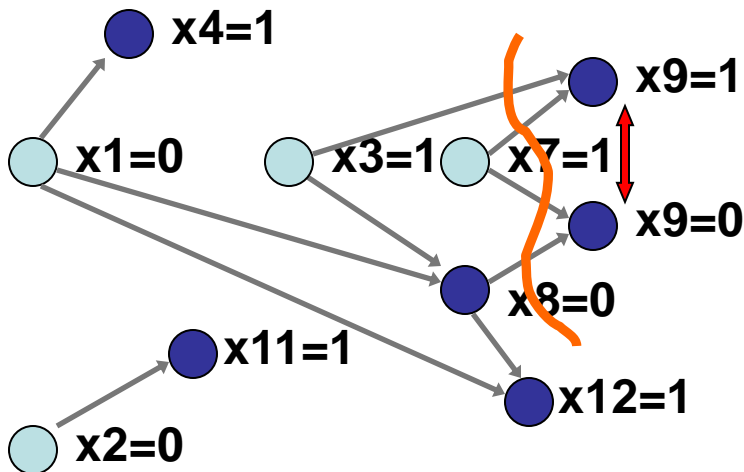

$x_3=1 \wedge x_7=1 \wedge x_8=0 \rightarrow \text{conflict}$

Add conflict clause: $x_3' + x_7' + x_8$

Conflict Driven Learning and Non-chronological Backtracking

$x_1 + x_4$

$x_1 + x_3' + x_8'$

$x_1 + x_8 + x_{12}$

$x_2 + x_{11}$

$x_7' + x_3' + x_9$

$x_7' + x_8 + x_9'$

$x_7 + x_8 + x_{10}'$

$x_7 + x_{10} + x_{12}'$

$x_3' + x_7' + x_8$

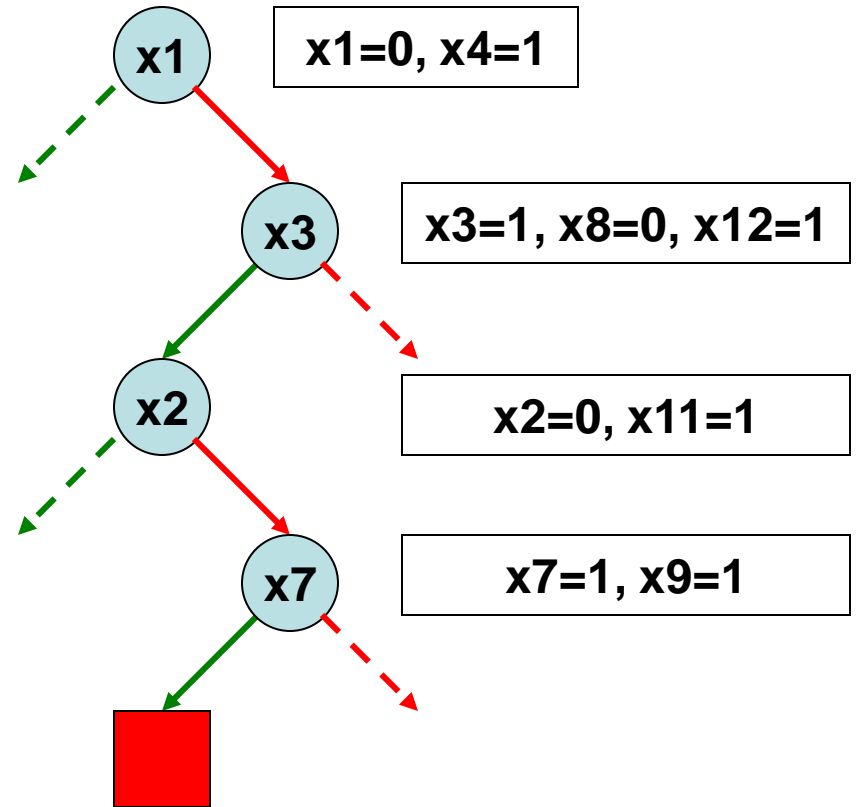
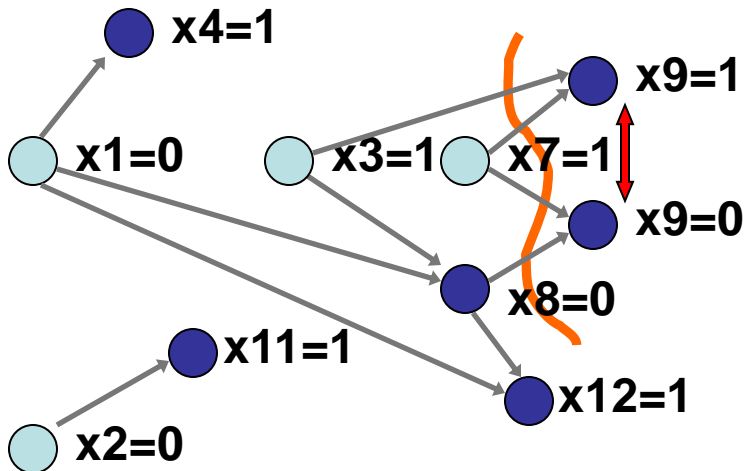

$x_3=1 \wedge x_7=1 \wedge x_8=0 \rightarrow \text{conflict}$

Add conflict clause: $x_3' + x_7' + x_8$

Conflict Driven Learning and Non-chronological Backtracking

$$x1 + x4$$

$$x1 + x3' + x8'$$

$$x1 + x8 + x12$$

$$x2 + x11$$

$$x7' + x3' + x9$$

$$x7' + x8 + x9'$$

$$x7 + x8 + x10'$$

$$x7 + x10 + x12'$$

$$x3' + x7' + x8$$

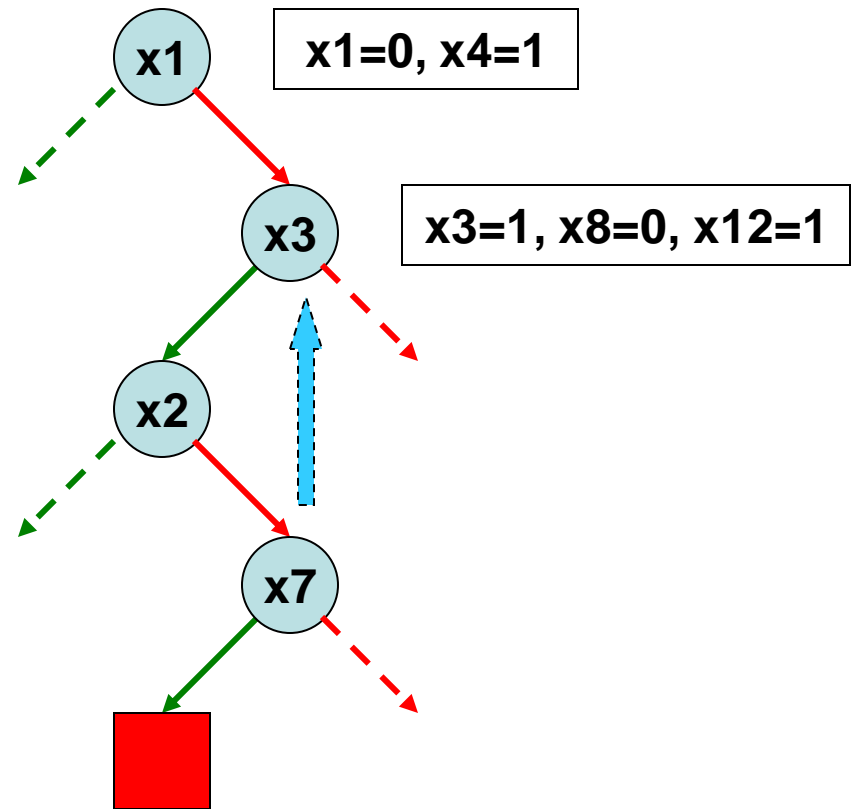
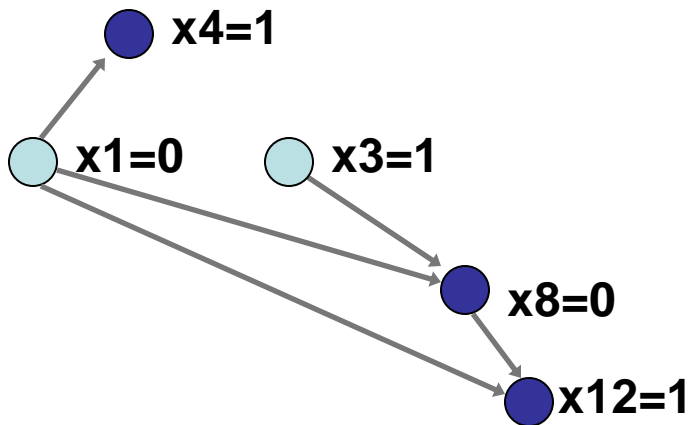

Backtrack to the decision level of $x3=1$
 $x7 = 0$

Conflict Driven Learning and Non-chronological Backtracking

$$x1 + x4$$

$$x1 + x3' + x8'$$

$$x1 + x8 + x12$$

$$x2 + x11$$

$$x7' + x3' + x9$$

$$x7' + x8 + x9'$$

$$x7 + x8 + x10'$$

$$x7 + x10 + x12'$$

$$x3' + x7 + x8'$$

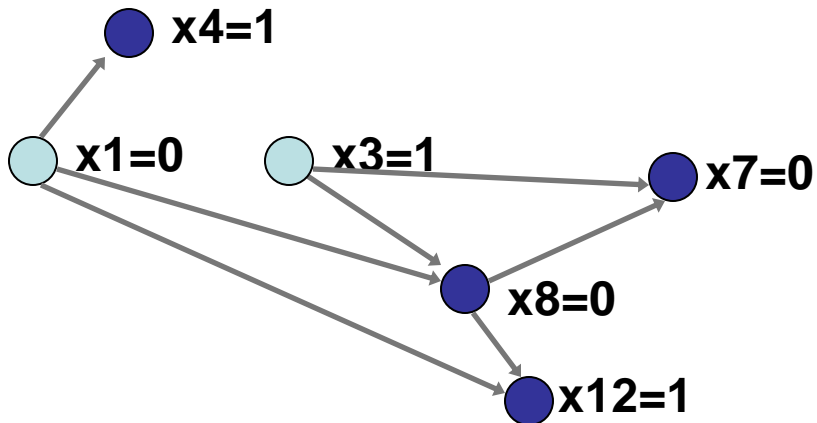
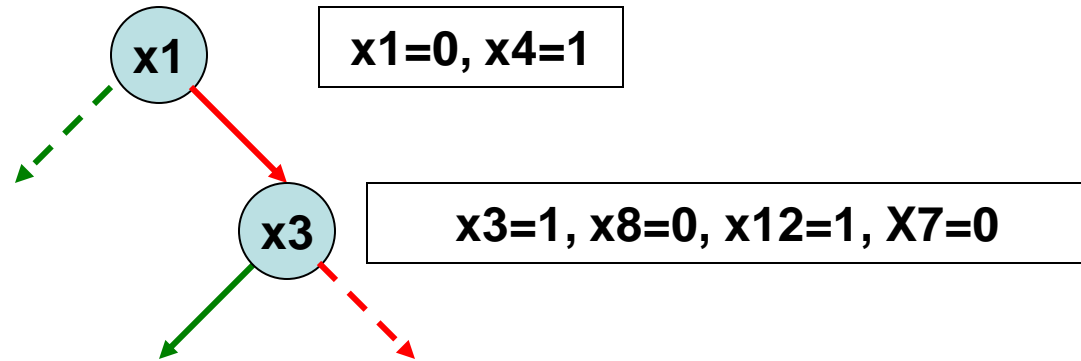

What's the big deal?

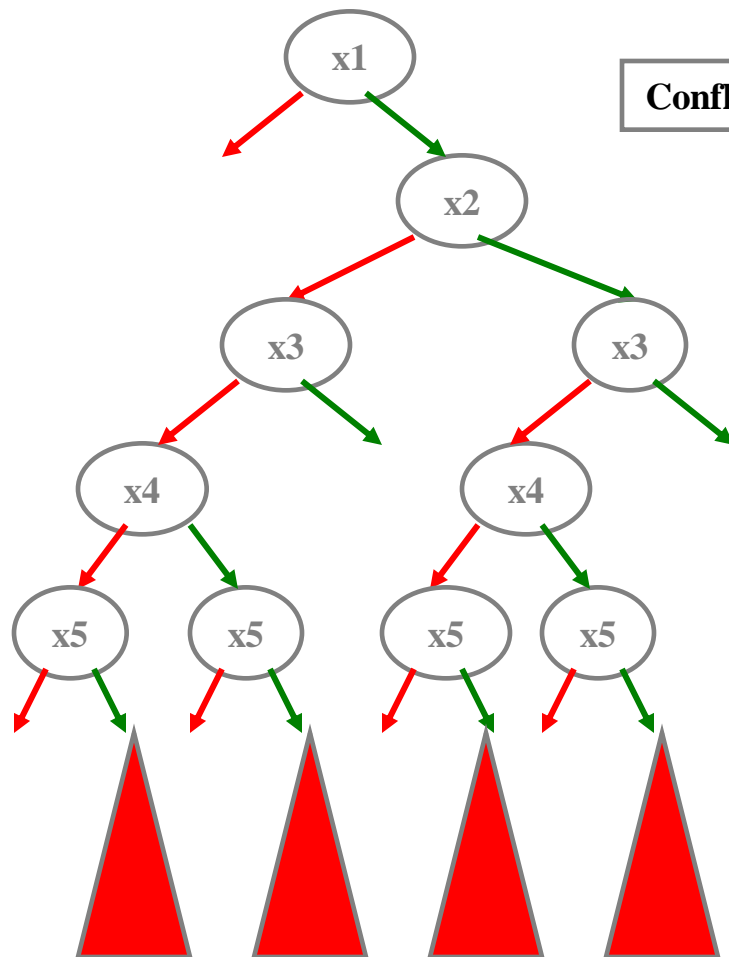

Significantly prune the search space –
learned clause is useful forever!

Useful in generating future conflict
Clauses

No longer polynomial space

Restart

- Abandon the current search tree and reconstruct a new one
- The clauses learned prior to the restart are *still there* after the restart and can help pruning the search space
- Adds to robustness in the solver

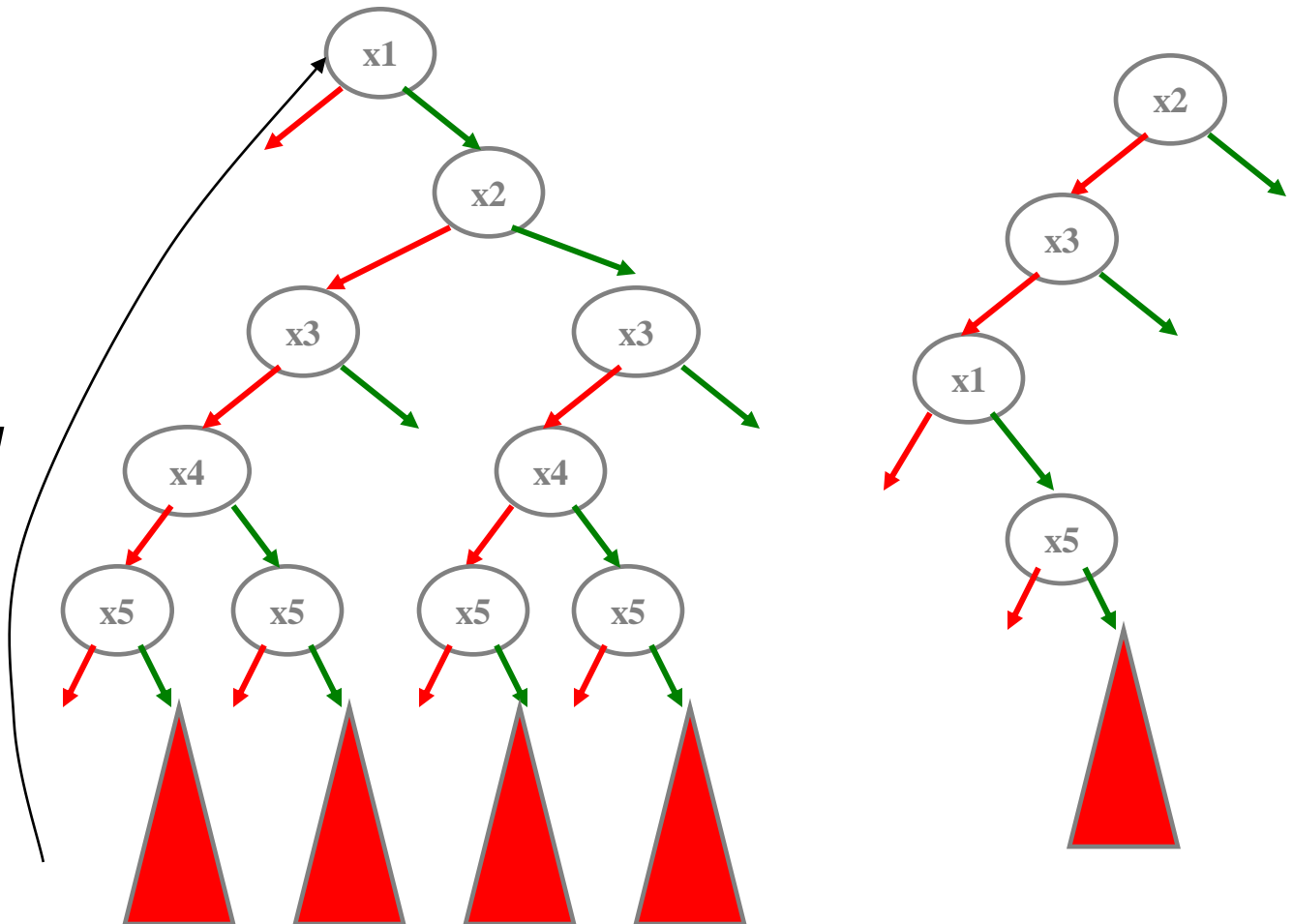

Conflict clause: $x1' + x3 + x5'$

BCP Algorithm

- What “causes” an implication? When can it occur?
 - All literals in a clause but one are assigned to F
 - $(v_1 + v_2 + v_3)$: implied cases: $(0 + 0 + v_3)$ or $(0 + v_2 + 0)$ or $(v_1 + 0 + 0)$
 - For an N-literal clause, this can only occur after N-1 of the literals have been assigned to F
 - So, (theoretically) we could completely ignore the first N-2 assignments to this clause
 - In reality, we pick two literals in each clause to “watch” and thus can ignore any assignments to the other literals in the clause
 - Example: $(v_1 + v_2 + v_3 + v_4 + v_5)$
 - $(\mathbf{v_1=X} + \mathbf{v_2=X} + v_3=? \text{ {i.e. X or 0 or 1}} + v_4=? + v_5=?)$

Chaff Decision Heuristic - VSIDS

- Variable State Independent Decaying Sum
 - Rank variables by literal count in the initial clause database
 - Periodically, divide all counts by a constant
 - Only increment counts as new clauses are added
- Quasi-static:
 - Static because it doesn't depend on var state
 - Not static because it gradually changes as new clauses are added
 - Decay causes bias toward *recent* conflicts

Finding a Solution to a SAT problem is can be viewed as 2 player game

- Player 1: tries to find satisfying assignment
- Player 2: tries to show that such assignment does not exist

Let A be an arbitrary assignment
while true:

if $A \models C$ then return SAT

if $() \in C$ then return UNSAT

let $c \in C$ such that not $A \models c$ and let A' such that $A' \models c$

$A := A'$

||

let $c' \notin C$ such that $C \models c'$ and not $A \models c'$

$C := C \cup \{c'\}$

Example Game 1

□

$$(a + b)(a + b')(a' + c)(a' + c')$$

Example Game 2

□

$$(a + b + c)(b + c' + f')(b' + e)$$

Some Bibliography

- **Chaff: Engineering an Efficient SAT Solver**
Matthew W. Moskewicz, Conor F. Madigan, Ying Zhao, Lintao Zhang, Sharad Malik (DAC'01)
- **Efficient Conflict Driven Learning in a Boolean Satisfiability Solver** Lintao Zhang, Conor F. Madigan, Matthew H. Moskewicz (IJCAD'01)
- **A New Method for Solving Hard Satisfiability Problems**
Bart Selman, Hector Levesque, David Mitchell (AAI'92)

Missing

- Post Chaff SAT solvers
 - BerkMin
 - Seige
 - miniSat
 - HaifaSAT
 - JeruSAT (Alex Nadel)
- The Stålmarck's algorithm
- Hyperresolution
- Local Search

Open Question

- Is there a subset of a useful propositional logic beyond Horn clauses which:
 - Allows polynomial SAT
 - Includes many of the practical instances
 - Some recent ideas in
 - Zack Newsham, Vijay Ganesh, Sebastian Fischmeister, Gilles Audemard, Laurent Simon:
Impact of Community Structure on SAT Solver Performance.
SAT 2014: 252-268

Summary

- Rich history of emphasis on practical efficiency
- Need to account for computation cost in search space pruning
- Need to match algorithms with underlying processing system architectures
- Specific problem classes can benefit from specialized algorithms
 - Identification of problem classes?
 - Dynamically adapting heuristics?
- We barely understand the tip of the iceberg here
 - much room to learn and improve