

# POWER AND FREQUENCY CONTROL

- **Chapter 4**
- **Weedy & Cory, Electric Power Systems**

# POWER AND FREQUENCY CONTROL

- **ACTIVE POWER AND FREQUENCY CONTROL**
- **Chapter 4**
- **Page 163**
  
- **Morning**
  - Rate of increase in demand is very high
- **Boiler control**
- **Speed governor control in turbine**
  - More steam for more power output

# POWER AND FREQUENCY CONTROL

- Kinetic Energy is a function of

1. moment of inertia,  $I$ , kg-m<sup>2</sup>
2. speed and,  $\omega = n \times 2\pi / 60$ , rad / sec

$$K.E. = \frac{1}{2} m v^2$$

$$= \frac{1}{2} m (\omega r)^2$$

$$= \frac{1}{2} (m r^2) \omega^2$$

$$= \frac{1}{2} I \omega^2$$

- But frequency,  $f$ , depends on angular speed.  $f = p n / 120$ .

- Therefore  $K.E. \propto \omega^2 \propto f^2$

# POWER AND FREQUENCY CONTROL

- **Example 1**

- An isolated 75 MVA generator feeds its own load and operates initially at no load at 3,000 rpm i.e. 50 HZ. A 20 MW load is suddenly applied and the steam valves of the turbine commence to open after 0.5 second due to the time lag in the governor system. Calculate the frequency to which the generated voltage drops before steam flow meets the new load. The stored energy for the machine is 4 kW-sec per kVA of generator capacity.

# POWER AND FREQUENCY CONTROL

- **Example 1**

- An isolated 75 MVA generator feeds its own load and operates initially at no load at 3,000 rpm i.e. 50 HZ. A 20 MW load is suddenly applied and the steam valves of the turbine commence to open after 0.5 second due to the time lag in the governor system. Calculate the frequency to which the generated voltage drops before steam flow meets the new load. The stored energy for the machine is 4 kW-sec per kVA of generator capacity.

- **Solution**

- K.E. =  $4 \times 75 = 300$  MW-sec
- (-)  $0.5 \times 20 = 10$
- -----
- Balance = 290 MW-sec

$$\left(\frac{f_1}{f}\right)^2 = \frac{290}{300}$$

$$f_1 = 50 \times \sqrt{\frac{290}{300}} = 49.2 \text{ Hz}$$

# POWER AND FREQUENCY CONTROL

- PRIME MOVER
  - Mechanical power input
  - Controlled by governor

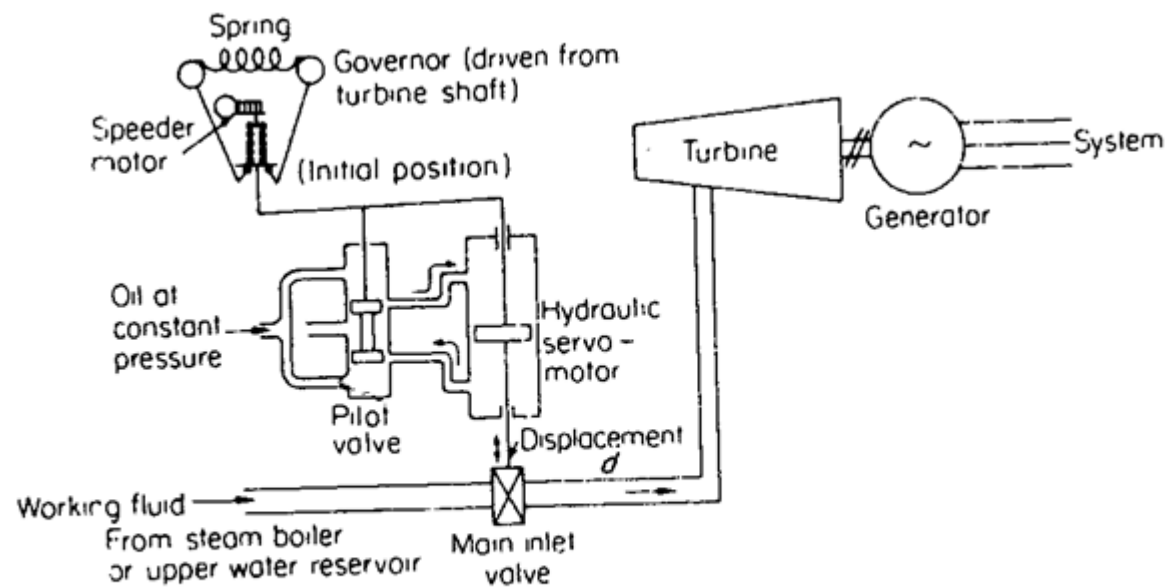

(B. Weedy & B. Cory, *Electric Power Systems*, 4<sup>th</sup> edition, John Wiley & Sons, 1999, Page 164)

# POWER AND FREQUENCY CONTROL

## • GOVERNOR CHARACTERISTICS

- Droop characteristic is a straight line.
  - Speeder gear can shift characteristic parallel to itself.
- The most desirable operation
  - Unit power output occurs at per unit speed (frequency).
- Same frequency in Interconnected system.
  - Two generators with different droop characteristics may share load unequally.
  - Characteristic of one machine may be shifted to share the load equally.
- See pp164-6.

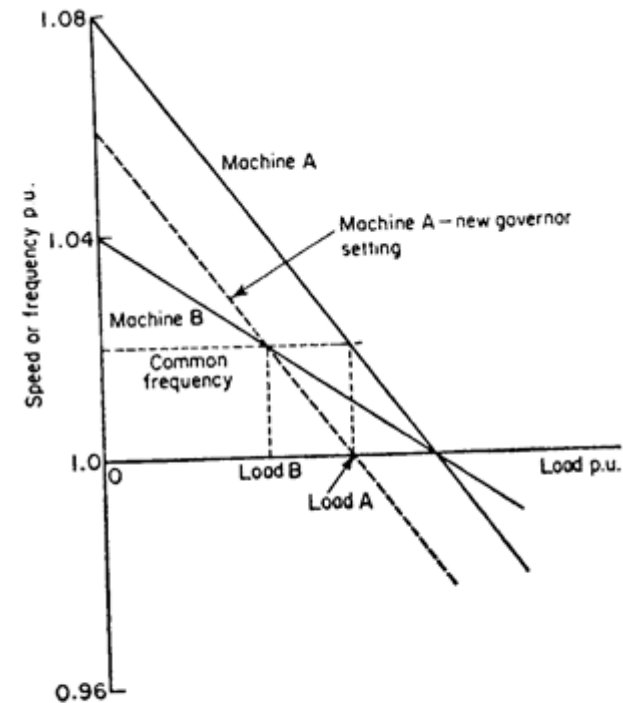

(B. Weedy & B. Cory, *Electric Power Systems*, 4<sup>th</sup> edition, John Wiley & Sons, 1999, Page 170)

# POWER AND FREQUENCY CONTROL

- **Example 2**

- Two synchronous generators operate in parallel and supply a total load of 200 MW. The capacities of the machines are 100 MW and 200 MW.
- Both have the governor droop characteristics of 4 percent from no-load to full-load.
- Calculate the load taken by each machine assuming free governor action.
- Also determine the frequency at which the paralleled machine deliver the load.



# POWER AND FREQUENCY CONTROL

- **Solution to Example 2**

- Total power = 200 MW
- Machine A supplies  $x$  MW
- Machine B supplies  $200 - x$  MW
- From similar triangles:

$$\frac{0.04}{100} = \frac{\alpha}{x} \quad \frac{0.04}{200} = \frac{\alpha}{200 - x}$$

$$\alpha = \frac{0.04x}{100} = \frac{0.04}{200}(200 - x)$$

- Machine A:  $x = 66.7$  MW.
- Machine B:  $200 - x = 133.3$  MW.
- Note: Machines supply load in proportion to their ratings. This is due to identical droop characteristics.

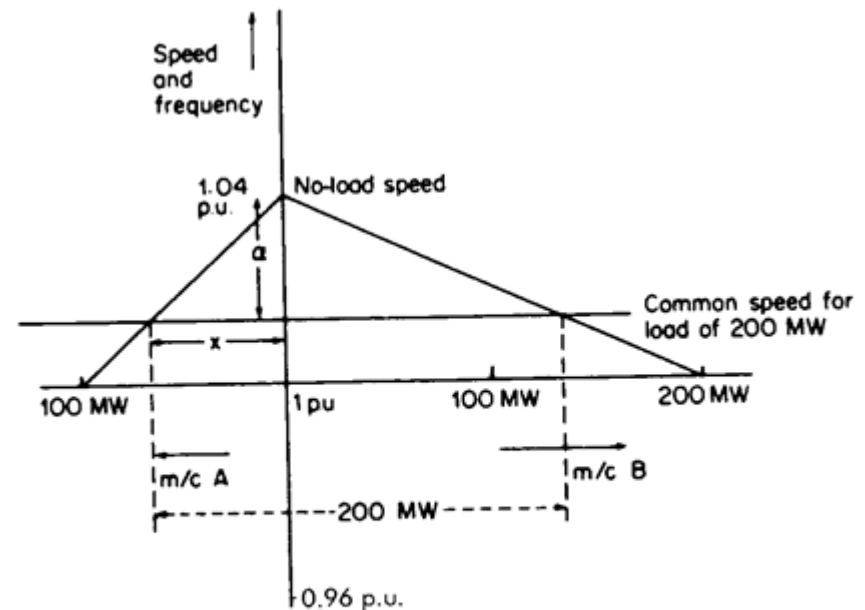

(B. Weedy & B. Cory, *Electric Power Systems*, 4<sup>th</sup> edition, John Wiley & Sons, 1999, Page 171)

# POWER v FREQUENCY

- **INTERCONNECTED SYSTEM**

- Change in power demand causes a change in frequency.

- $\Delta P =$  Change in power demand  
= Change in load power – change in generated power  
=  $\Delta P_L - \Delta P_G$

- $\Delta P_L = \Delta P_{L\text{-new}} - \Delta P_{L\text{-old}}$

- Stiffness (constant) =  $\Delta P / \Delta f = -K$  (MW/Hz)

- $\Delta P + K \Delta f = 0$

- $K$  is a function of governor and load characteristics.

- Stiff system

- Large change in  $P$  causes small change in  $f$  i.e.  $K$  is large.

# POWER v FREQUENCY

- **INTERCONNECTED SYSTEM**

- $\Delta P + K \Delta f = 0$

- Suppose two interconnected systems A and B lose the interconnecting line. The following were measured for system A.

- $\Delta P = 500 \text{ MW}; \Delta f = 0.1 \text{ Hz}$

- Then

- $K_A = 500/0.1 = 5,000 \text{ MW/Hz}$

- For small systems

- K is small i.e.  $\Delta f$  is large for a small  $\Delta P$ .

# POWER AND FREQUENCY CONTROL

- **Example**

- Power  $\Delta P_T$  is transmitted from system A to system B. System frequency is  $f$ . If the link is broken, A has excess and B has deficit generation of  $\Delta P_T$ .

- For System A

- $\Delta P_{GA} = 0, \Delta P_{LA} = 0 - \Delta P_T = -\Delta P_T, \quad -K_A = \Delta P_A / \Delta f_A$

- $\Delta P_A = \Delta P_{LA} - \Delta P_{GA} = -\Delta P_T - 0 = -\Delta P_T$

- $\Delta f_A = f_A - f = \Delta P_A / -K_A = (-\Delta P_T) / (-K_A) = \Delta P_T / K_A$

- $f_A = f + \Delta f_A = f + \Delta P_T / K_A$

Continued to next slide

# POWER AND FREQUENCY CONTROL

- **Example** (continued from previous slide)
- Power  $\Delta P_T$  is transmitted from system A to system B. System frequency is  $f$ . If the link is broken, A has excess and B has deficit generation of  $P_T$ .
- For System B
- $\Delta P_L = 0$  and  $\Delta P_G = -\Delta P_T$   $-K_A = \Delta P_A / \Delta f_A$
- Determine  $f_B = f - \Delta P_T / K_B$ .

# POWER AND FREQUENCY CONTROL

$$\Delta P_G = 0 \quad \Delta P_L = 0 - (\Delta P_T) = -\Delta P_T \quad -K_A = \frac{\Delta P_A}{\Delta f_A}$$

- **System A**

$$\Delta P_A = \Delta P_{AL} - \Delta P_{AG} = -\Delta P_T - 0$$

$$f_A = f + \frac{\Delta P_T}{K_A}$$

$$\Delta f_A = f_A - f = \frac{\Delta P_A}{-K_A} = \frac{(-\Delta P_T) - 0}{-K_A} = \frac{\Delta P_T}{K_A}$$

$$f_A = f + \frac{\Delta P_T}{K_A}$$

- **System B**

$$\Delta P_B = \Delta P_{BL} - \Delta P_{BG} = -0 - \Delta P_T$$

$$\Delta f_B = f_B - f = \frac{\Delta P_B}{-K_B} = \frac{0 - (-\Delta P_T)}{-K_B}$$

$$f_B = f - \frac{\Delta P_T}{K_B}$$

# POWER AND FREQUENCY CONTROL

- **FREQUENCY BIAS TIE LINE CONTROL**

- The above can be extended to any number of interconnected systems. The guiding relations for three interconnected systems A,B and C are:

$$\sum \Delta P_A + K_A \Delta f_A = 0$$

$$\sum \Delta P_B + K_B \Delta f_B = 0$$

$$\sum \Delta P_C + K_C \Delta f_C = 0$$

# POWER AND FREQUENCY CONTROL

- **COMPUTER CONTROL OF LOAD FREQUENCY**
  - Spinning reserve (not the same as K.E.)
  - Voltage control
  - Stability
  - Protection requirements
  - Optimization



# POWER AND FREQUENCY CONTROL

- Synchronous machine connected to a system
- $P_{\text{out}} \propto \text{Steam input}$

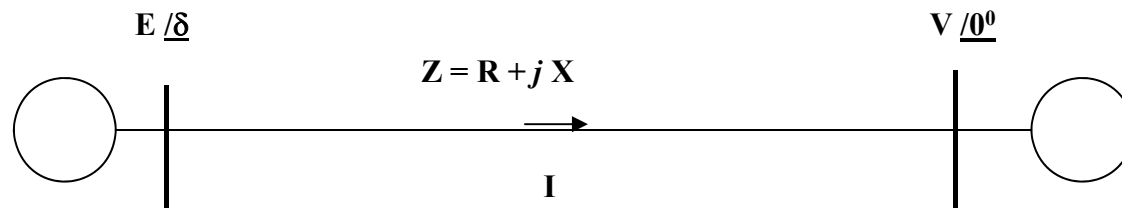

# POWER AND FREQUENCY CONTROL

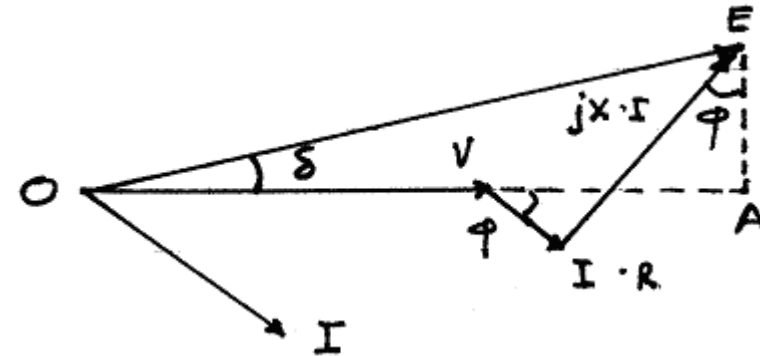
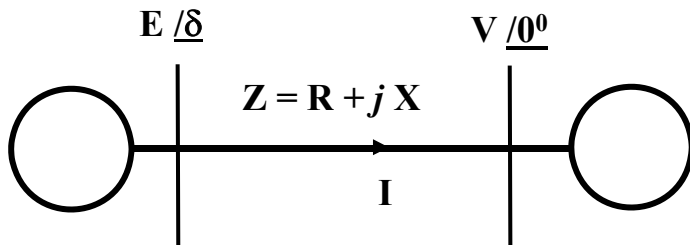

For small  $\delta$ ,

$$OA \cong |E|$$

$$\Delta V = |E| - |V|$$

$$= IR \cos \phi + IX \sin \phi = \frac{R}{V} \cdot (VI \cos \phi) + \frac{X}{V} \cdot (VI \sin \phi)$$

$$= \frac{RP}{V} + \frac{XQ}{V} = \frac{RP + XQ}{V}$$

$$\sin \delta = \frac{EA}{OE} = \frac{IX \cos \phi - IR \sin \phi}{E} = \frac{\frac{XP}{V} - \frac{RQ}{V}}{E} = \frac{XP - RQ}{VE}$$

# POWER AND FREQUENCY CONTROL

$$\sin \delta = \frac{XP - RQ}{VE} \cong \frac{XP}{VE} \text{ since } R \ll X$$

Remember ??  $P = \frac{EV}{X} \sin \delta$

- $P = f(\delta)$
- **Flow of power determined by the angle.**
- **Hence  $\delta$  is known as *power angle* or *load angle*.**
  
- **More about voltage control later**
- **Back to power and frequency control**

# POWER AND FREQUENCY CONTROL

- **Power angle**

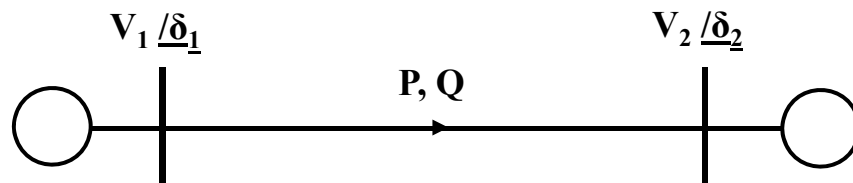

$$P = \frac{E V}{X} \sin \delta$$

- when  $\delta = \delta_1 - \delta_2 = 0$ :
  - no power is transferred from Bus 1 to Bus 2 i.e.  $P = 0$ .
- When  $\delta > 0$ :
  - net power is **delivered** from Bus 1 to Bus 2 i.e.  $P > 0$ .
- When  $\delta < 0$ :
  - net power is **received** at Bus 1 from Bus 2 i.e.  $P < 0$ .

# POWER AND FREQUENCY CONTROL

$$\Delta V = \frac{R P + X Q}{V} \cong \frac{X Q}{V}$$

- $Q = f(\Delta V)$  :
- **Voltage difference (magnitude) determines flow of reactive power.**
  - If  $V_1 = V_2$ ,  $Q = 0$ .
  - If  $V_1 > V_2$ ,  $Q > 0$ .
  - If  $V_1 < V_2$ ,  $Q < 0$ .
- Since  $V$  is constant,  $Q$  depends on  $E$  i.e.  $I_f$ .
- Remember??  $P$  depends on input mechanical power.

# POWER AND FREQUENCY CONTROL

- **Control of P and Q**

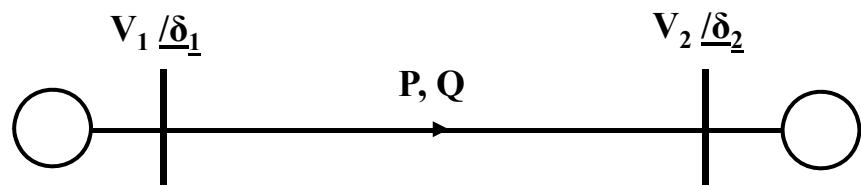

$$P = \frac{EV}{X} \sin \delta$$

$$\Delta V \cong \frac{XQ}{V}$$

- **P and Q can be controlled almost independently**
- **If  $r/x$  is small**

# POWER AND FREQUENCY CONTROL

- **REFERENCES**

- B. M. Weedy and B. J. Cory, Electric Power Systems, 4th Ed, John Wiley & Sons.