



Linear Precoding Schemes for PAPR Reduction in Mobile WiMAX OFDMA System

Jijina N.¹, Dr. Sakuntala S. Pillai, Senior member IEEE²

PG Student [TCE], Dept. of ECE, Mar Baselios College of Engineering & Technology, Kerala, India¹

Dean (R&D), Dept. of ECE, Mar Baselios College of Engineering & Technology, Kerala India²

ABSTRACT: The mobile WiMAX air interface adopts Orthogonal Frequency Division Multiple Access (OFDMA) as multiple access technique for its uplink and downlink transmission. All OFDMA based systems, including mobile WiMAX, experience the problem of high peak-to-average power ratio (PAPR). Each symbol block is linearly transformed by a precoding matrix before OFDM modulation and transmission in linear precoding. This paper provides a comparison of three typical linear precoding techniques: Hadamard transform precoding, Discrete Sine Transform precoding and Square root raised cosine function precoding used in OFDMA system. The performance of these different schemes in terms of PAPR reduction is analyzed with the conventional Random Interleaved OFDMA system.

KEYWORDS: OFDMA; Mobile WiMAX; PAPR; Precoding; CCDF; WHT Matrix; Square Root Raised Cosine Function; Discrete Sine Transform.

I. INTRODUCTION

The ever increasing demand for very high data rate wireless transmission due to the increase of mobile data usage and emergence of new applications such as Multimedia online gaming, mobile TV etc calls for technologies which make use of the available resources in the most intelligent way. The Worldwide Interoperability for Microwave Access (WiMAX) is one of the hottest broadband wireless technologies around today. Mobile WiMAX based on IEEE 802.16m standard, as an advanced air interface to meet the requirements of ITU-R/IMT-Advanced for 4G systems enables the convergence of mobile and fixed broadband networks through a wide area radio access [1]. OFDM is one of the Multi-Carrier Modulation (MCM) techniques, which divides the available spectrum into many carriers known as subcarriers, and each one being modulated by a low rate data stream. Here, all of the subcarrier spectra exhibit zero crossings at all of the remaining subcarrier frequencies and the individual subcarrier spectra are orthogonal to each other. This ensures that the subcarrier signals do not interfere with each other, when communicating over perfectly distortion free channels, as a consequence of their orthogonality [2-3]. Each subcarrier delivers information for a different user, resulting in a simple multiplexing scheme called Orthogonal Frequency Division Multiple Access (OFDMA) [4-6].

The mobile WiMAX air interface adopts OFDMA as multiple access technique for its uplink and downlink. Low complexity required in transmission and reception, high implementation flexibility as well as the attainable high performance render OFDMA a highly attractive candidate for high data rate communications over time-varying frequency selective radio channels affected by multipath distortion. The major difference between OFDM and OFDMA is that, in OFDM all the available subcarriers are allocated to a single user, where as in OFDMA, the base station assigns only a subset of carriers to each user. This facilitates several transmissions simultaneously. OFDMA based systems exploit multiuser diversity through subcarrier allocation. Two different approaches for subcarrier mapping in OFDMA systems are localized subcarrier mapping and distributed subcarrier mapping. The distributed scheme can be further categorized into two modes as interleaved mode and random interleaved mode. The random interleaved mode offers increased capacity and maximum frequency diversity in frequency selective fading channels. Hence it is a better choice for Mobile WiMAX. Subcarrier mapping in the interleaved mode, where subcarriers are mapped equidistant to each other is shown in Fig. 1. Subcarriers are mapped randomly based on a permutation algorithm in random interleaved mode as illustrated in Fig. 2.

International Journal of Advanced Research in Electrical, Electronics and Instrumentation Engineering

(An ISO 3297: 2007 Certified Organization)

Vol. 3, Issue 4, April 2014

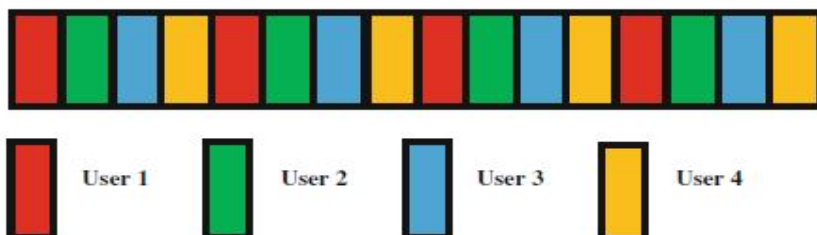

Fig.1. Interleaved OFDMA

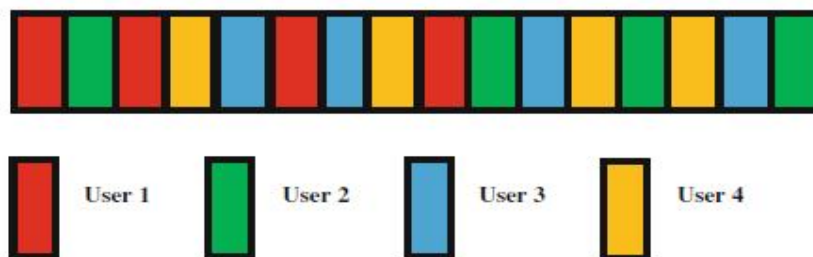

Fig.2. Random Interleaved OFDMA

OFDMA has been widely adopted in various communication standards like Mobile Broadband Wireless Access (MBWA), WiMAX, Evolved UMTS Terrestrial Radio Access (E-UTRA), Wireless Regional Area networks (WRAN) and the Long Term Evaluation Advanced (LTE-Advanced). One of the critical issues of OFDM based system is its high Peak-to-Average Power Ratio (PAPR). Those systems could face serious restriction for practical applications, if there is no proper measure to reduce the high PAPR of the OFDM System. This paper provides a comparison of various linear precoding techniques used with OFDMA uplink in Mobile WiMAX. The rest of this paper is organized as follows: In section II, the related works are presented. Section III briefly describes the conventional Random Interleaved OFDMA uplink system and the problem of high peak-to-average power ratio (PAPR). Theory of precoding and the explanation of three typical linear precoding techniques; Hadamard Transform (WHT) Precoding, Discrete Sine Transform (DST) precoding, Square root raised cosine function precoding are made in section IV. Simulation results, discussions and comparisons of these techniques in terms of PAPR reduction are provided in Section V. Finally, some conclusions are given in Section VI.

II. RELATED WORKS

Various techniques have been proposed in literature to mitigate the effect of high PAPR in OFDM systems [7-9]. Among them some schemes are Clipping and filtering [10-11], Selective mapping (SLM) [12], Partial transmit sequence (PTS) [13], Tone Injection [7], Tone Reservation [7], Non linear companding transforms [7], phase optimization [14], Precoding based techniques [15-20] etc. Most of these techniques provide significant reduction in PAPR at an expense of high complexity to the transceivers, high coding overhead, performance degradation etc. Precoding based techniques are linear, simple techniques and can be implemented without the use of any overhead. In linear precoding, each OFDMA block is linearly transformed by a precoding matrix before OFDM modulation and transmission [15]. This approach has the potential of reducing the PAPR of the OFDM without affecting the bandwidth efficiency and the Bit Error Rate (BER) performance of the system. Entries of the precoding matrix are chosen in such a way that the detectability property of the different symbols of the OFDMA block is preserved. No handshake is required since predefined matrix is used for precoding. Miin-Jong Hao [16] enhanced the performance of precoding

International Journal of Advanced Research in Electrical, Electronics and Instrumentation Engineering

(An ISO 3297: 2007 Certified Organization)

Vol. 3, Issue 4, April 2014

by deriving the optimal condition for precoding matrices. Precoding techniques are used by the MIMO-OFDM systems also for PAPR reduction [17-19]. A discrete sine transform based precoding for OFDMA system was proposed by Imran Baig *et al* [20].

III. CONVENTIONAL RI-OFDMA SYSTEM AND PAPR DEFINITION

A. Conventional RI-OFDMA uplink system

Assume that the OFDMA system consists of a total of N subcarriers and they are evenly divided among P users. Thus each user can have $M = N/P$ subcarriers. In Random Interleaved-OFDMA system, the subcarriers are randomly mapped to each user. The block diagram illustration of a RI-OFDMA uplink system is shown in Fig. 3. The input data stream after baseband modulation, are passed through serial-to-parallel (S/P) converter that generates a complex input vector of size M . Generally used baseband modulation schemes are M -ary PSK/QAM. The input vector X is given as:

$$X = [X_0, X_1, X_2, \dots, X_{M-1}]^T \tag{1}$$

where $[\cdot]^T$ denotes transpose operation.

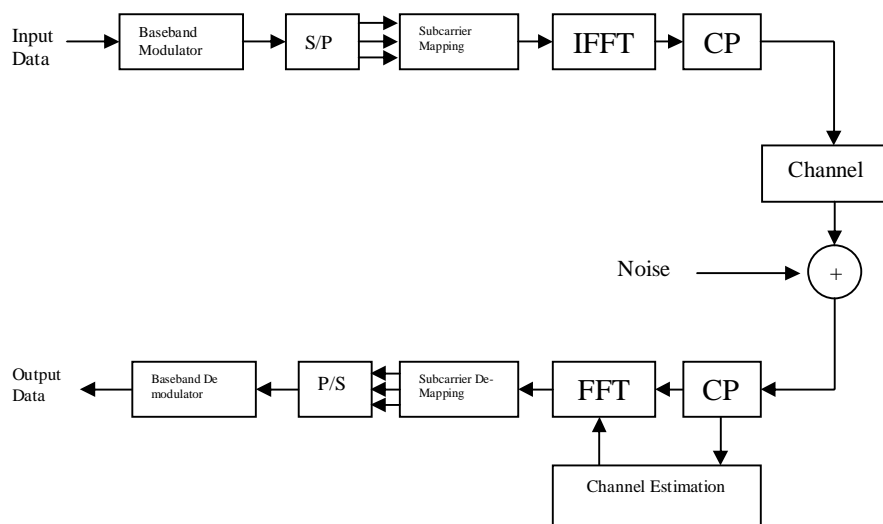

Fig.3. Random Interleaved OFDMA uplink system

The subcarrier mapping is done on these constellation symbols in random-interleaved mode (based on the permutation algorithm of IEEE 802.16e) to get frequency domain samples $\{\hat{X}_m : m = 0, 1, 2, \dots, N - 1\}$. Mathematically, the subcarrier mapping in random interleaved mode can be done as follows:

$$\hat{X}_m = \begin{cases} X_{\frac{m}{\hat{P}}}, & m = \hat{P} \cdot k \quad 0 \leq k \leq M - 1 \\ 0, & \text{Otherwise} \end{cases} \tag{2}$$

where $0 \leq m \leq N - 1$, $N = P \cdot M$ and $0 \leq \hat{P} \leq P$ is the spreading factor.



International Journal of Advanced Research in Electrical, Electronics and Instrumentation Engineering

(An ISO 3297: 2007 Certified Organization)

Vol. 3, Issue 4, April 2014

Suppose the k^{th} user is assigned to subchannel k , then the complex baseband RI-OFDMA uplink signal for k^{th} user with N system subcarriers and M user subcarriers can be written as follows:

$$x_n^{(k)} = \frac{1}{\sqrt{N}} \sum_{m=0}^{N-1} (\hat{X}_m \cdot e^{j2\pi \frac{n}{N} m}), n = 0, 1, 2, \dots, N-1 \quad (3)$$

The output of IFFT is then passed through parallel-to-serial converter and then transmitted through the channel to the receiver.

B. Peak-to-Average Power Ratio (PAPR)

PAPR is the ratio between the maximum power and the average power of the OFDM transmitted signal $x(t)$, i.e.

$$PAPR\{x(t)\} = \frac{\max|x(t)|^2}{E\{|x(t)|^2\}} \quad (4)$$

where $\max|x(t)|^2$ is the maximum power and $E\{|x(t)|^2\}$ is the average power. In Eq. (4), $E\{\cdot\}$ denotes the expected value.

$$PAPR(dB) = 10 \log_{10} PAPR \quad (5)$$

In practice, it is preferred to take the probability of PAPR exceeding a threshold as measurement index to represent the distribution of PAPR. This can be described as “Complementary Cumulative Distribution Function (CCDF)”, and its mathematical expression is given by

$$P(PAPR > Z) = 1 - P(PAPR \leq Z) = 1 - F(Z)^N = 1 - (1 - \exp(-Z))^N \quad (6)$$

Thus CCDF of the PAPR of the data block is desired is our case to compare outputs of various reduction techniques.

IV. DIFFERENT LINEAR PRECODING TECHNIQUES

A. Linear Precoding Technique

Precoding in OFDMA systems consists of multiplying the modulated data of each OFDM block by a precoding matrix before OFDM modulation and transmission. The predefined precoding matrix can be represented as:

$$P = \begin{bmatrix} p_{0,0} & \cdots & p_{0,N-1} \\ \vdots & \ddots & \vdots \\ p_{L-1,0} & \cdots & p_{L-1,N-1} \end{bmatrix} \quad (7)$$

where $P_{i,j}$ is the complex entries of precoding matrix, $(L = N + N_p)$, is the total number of subcarriers and N_p is the extra subcarriers (overhead). The block schematic of a precoded OFDMA system is shown in Fig.4. The set of N baseband modulated signals can be represented as

$$X = [X_0, X_1, \dots, X_{N-1}]^T \quad (8)$$

International Journal of Advanced Research in Electrical, Electronics and Instrumentation Engineering

(An ISO 3297: 2007 Certified Organization)

Vol. 3, Issue 4, April 2014

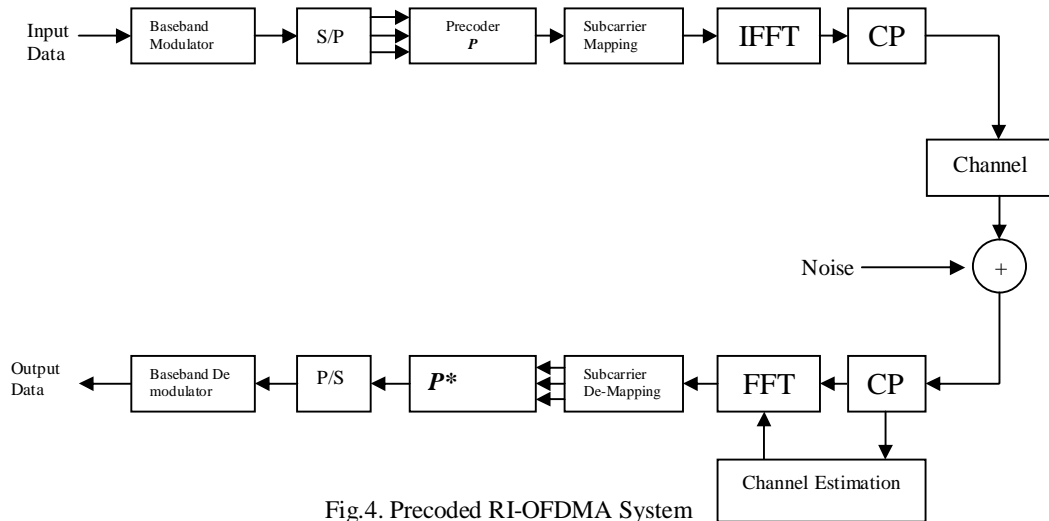

Fig.4. Precoded RI-OFDMA System

The precoding process transforms this vector into new vector of length L with

$$Y = P \cdot X = [Y_0, Y_1, \dots, Y_{L-1}]^T \tag{9}$$

$$\text{where } Y_i = \sum_{m=0}^{N-1} p_{i,m} X_m, \quad i = 0, 1, \dots, L - 1 \tag{10}$$

For OFDM systems with MPSK modulation schemes and uncorrelated symbols within each OFDM block, the PAPR of the OFDM signal at a given time instant t can be upper bounded as follows:

$$PAPR(t) < \frac{1}{N} \times \left(\sum_{m=0}^{N-1} \left| \sum_{i=0}^{L-1} p_{i,m} e^{j2\pi i \frac{t}{T}} \right| \right)^2 \tag{11}$$

and the maximum PAPR is then obtained as

$$PAPR_{max} = \max_{0 \leq t \leq T} PAPR(t) = \frac{1}{N} \max_{0 \leq t \leq T} \left(\sum_{m=0}^{N-1} \left| \sum_{i=0}^{L-1} p_{i,m} e^{j2\pi i \frac{t}{T}} \right| \right)^2 \tag{12}$$

Hence PAPR is a function of OFDM block size and the entries of the precoding matrix. Since OFDM block size is fixed, one can reduce the PAPR by the proper selection of the precoding matrix P. Select the precoding matrix as an orthogonal matrix, which satisfies the following relation to preserve the symbol separability property of OFDM scheme.

$$P^* \cdot P = I, \text{ where } I \text{ is the } N \times N \text{ identity matrix} \tag{13}$$

B. Hadamard Transform (WHT) Precoding Technique

The Hadamard transform is an orthogonal linear transform, which can be implemented by a structure similar to as FFT. The kernel of Hadamard transform can be written as

$$H_{2N} = \frac{1}{\sqrt{2N}} \begin{bmatrix} H_N & H_N \\ H_N & H_N^{-1} \end{bmatrix}, \tag{14}$$



International Journal of Advanced Research in Electrical, Electronics and Instrumentation Engineering

(An ISO 3297: 2007 Certified Organization)

Vol. 3, Issue 4, April 2014

where H_N^{-1} denotes the binary complement of H_N .

When WHT precoding is applied to the complex input vector of size M, this input vector is transformed to a new vector of size L that can be written as follows:

$$Y = H \cdot X = [Y_0, Y_1, \dots, Y_{L-1}]^T \quad (15)$$

where H is a WHT precoder matrix of size $N = L \times L$, and

$$Y_i = \sum_{m=0}^{N-1} h_{i,m} X_m, \quad i = 0, 1, \dots, L - 1 \quad (16)$$

$h_{i,m}$ correspond to i^{th} row and m^{th} column of WHT precoder matrix. After precoding, subcarrier mapping is performed on those precoded constellation symbols in random interleaved mode to get the frequency domain samples $\{\hat{Y}_i : i = 0, 1, 2, \dots, L - 1\}$.

Suppose the k^{th} user is assigned to subchannel k , then the complex baseband WHT precoded RI-OFDMA signal for k^{th} user can be written as follows:

$$y_n^{(k)} = \frac{1}{\sqrt{N}} \sum_{i=0}^{N-1} (\hat{Y}_i \cdot e^{j2\pi \frac{n}{N} i}), \quad n = 0, 1, 2, \dots, N - 1 \quad (16)$$

The PAPR of the WHT precoded RI-OFDMA signal can be calculated by Eq. (4) and Eq. (5).

C. Square Root Raised Cosine function (SRRC) Precoding Technique

Precoding matrix designed according to the Nyquist criteria can reduce the PAPR of the OFDM signal without altering the symbol separability property of the OFDM scheme. A well known function that satisfies the Nyquist criteria is the Raised Cosine function. The Fourier transform of the square root raised cosine function can be represented as follows:

$$P_{SRRC}(f) = \begin{cases} \sqrt{T_S} \sin\left(\frac{\pi f T_S}{2\beta} + \frac{\pi}{4}\right), & |f| \leq \frac{\beta}{2T_S} \\ \sqrt{T_S} \cdot \frac{\beta}{2T_S}, & \frac{\beta}{2T_S} \leq f \leq \frac{2-\beta}{2T_S} \\ \sqrt{T_S} \sin\left(\frac{\pi(f T_S - 1)}{2\beta} + \frac{3\pi}{4}\right), & \left|f - \frac{1}{T_S}\right| \leq \frac{2+\beta}{2T_S} \end{cases} \quad (17)$$

where $\beta = \frac{N_p}{N} = \frac{L-N}{N}$ defines the overhead or the portion of extra subcarriers used by the precoder.

The entries of the precoding matrix are generated using the wave shaping functions as

$$p_{i,m} = p_{i,0} e^{-j2\pi \frac{im}{N}} \quad (18)$$

with

$$p_{i,0} = \begin{cases} \frac{(-1)^i}{\sqrt{N}} \sin\left(\frac{\pi i}{2N_p}\right), & 0 \leq i \leq N_p \\ \frac{(-1)^i}{\sqrt{N}}, & N_p \leq i \leq N \\ \frac{(-1)^i}{\sqrt{N}} \cos\left(\frac{\pi(i-N)}{2N_p}\right), & N \leq i \leq L - 1 \end{cases} \quad (19)$$



International Journal of Advanced Research in Electrical, Electronics and Instrumentation Engineering

(An ISO 3297: 2007 Certified Organization)

Vol. 3, Issue 4, April 2014

When SRRC precoding is applied to the complex input vector of size M, this input vector is transformed to a new vector of size L that can be written as follows:

$$Y = P.X = [Y_0, Y_1, \dots, Y_{L-1}]^T \quad (20)$$

where P is a SRRC precoder matrix of size $N = L \times L$, generated using Eq. (19) and

$$Y_i = \sum_{m=0}^{N-1} p_{i,m} X_m, \quad i = 0, 1, \dots, L-1 \quad (21)$$

$p_{i,m}$ correspond to i^{th} row and m^{th} column of SRRC precoder matrix.

The PAPR of the SRRC precoded RI-OFDMA signal can be calculated by Eq. (4) and Eq. (5).

D. Discrete Sine Transform (DST) Precoding Technique

For an input signal d_n , the discrete sine transform D_k can be defined as:

$$D_k = \sum_{n=0}^{N-1} d_n \sin \left[\frac{\pi}{N+1} (n+1)(k+1) \right], \quad k = 1, 2, \dots, N-1 \quad (22)$$

DST precoding matrix S can be generated as follows:

$$S_{ij} = \begin{cases} \frac{1}{\sqrt{N}}, & i = 0, \quad 0 \leq j \leq N-1 \\ \frac{2}{\sqrt{N}} \sin \left(\frac{\pi(2j+1)i}{2N} \right), & 1 \leq i \leq N-1, \quad 0 \leq j \leq N-1 \end{cases} \quad (23)$$

The DST matrix must satisfy the following criteria:

1. Same magnitude for all the elements of the precoding matrix.
2. The magnitude must be equal to $\frac{1}{\sqrt{N}}$
3. The DST precoding matrix must be non singular matrix.

These criteria ensure that every output symbol has the same amount of information of every input data; it preserves the power at the output and also ensures the recovery of the original data at the receiver. When DST precoding is applied to the complex input vector of size M, this input vector is transformed to a new vector of size L that can be written as follows:

$$Y = S.X = [Y_0, Y_1, \dots, Y_{L-1}]^T \quad (20)$$

where S is a DST precoder matrix of size $N = L \times L$, generated by Eq. (23) and

$$Y_i = \sum_{m=0}^{N-1} s_{i,m} X_m, \quad i = 0, 1, \dots, L-1 \quad (21)$$

$s_{i,m}$ correspond to i^{th} row and m^{th} column of DST precoder matrix.

The PAPR of the DST precoded RI-OFDMA signal can be calculated by using Eq. (4) and Eq. (5). If we apply DST to the IFFT input sequence, it lowers the correlation relationship of the RI-OFDMA input sequence and hence reduces the PAPR of the transmitted signal.

V. SIMULATION RESULTS AND DISCUSSION

Monte Carlo simulation has been carried out to evaluate the effect of different linear precoding schemes like Hadamard transform precoding, discrete sine transform precoding and square root raised cosine function precoding on the PAPR of RI-OFDMA signal. Table 1 represents the simulation parameters used for PAPR analysis. PAPR is evaluated statistically by using CCDF. To show the PAPR analysis of different systems, data is generated randomly and modulated by QPSK or X-QAM (where X=16, 64, 128 and 256) respectively. PAPR analysis is also conducted for

International Journal of Advanced Research in Electrical, Electronics and Instrumentation Engineering

(An ISO 3297: 2007 Certified Organization)

Vol. 3, Issue 4, April 2014

different values of the roll of factor of the square root raised cosine function. All the simulations have been performed using 10^5 random data block.

Table1. System parameters to evaluate the PAPR

Modulation	QPSK, X-QAM (where X = 16, 64, 128 and 256)
Precoder Type	WHT, DST and SRRC
User Subcarriers	128
Precoder Size	128
System subcarriers	512
Roll off factor	0.1
CCDF clip rate	10^{-3}

Fig. 5 shows the CCDF comparison of PAPR of the different precoded RI-OFDMA system with conventional RI-OFDMA system. The horizontal axis represents the threshold for the PAPR and vertical axis represents the probability that the PAPR of a data block exceeds the given threshold. It can be seen that, at $CCDF=10^{-3}$, the PAPR is 10, 9.5, 8.1 and 8dB, for conventional RI-OFDMA system without precoding, for WHT precoded RI-OFDMA system, for SRRC precoded system and for DST precoded RI-OFDMA system, respectively. It can be observed that at $PAPR_0 = 8$ dB, the probability of a peak for DST precoded RI-OFDMA system is as small as 10^{-3} which is 10dB for the conventional RI OFDMA system. It is also clear that DST precoding based system provides considerable PAPR gain when compared to conventional RI-OFDMA system without precoding using QPSK modulation.

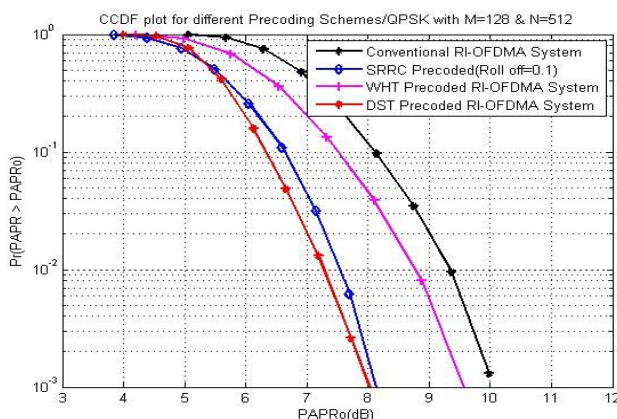

Fig.5. CCDF based comparison of PAPR of WHT, DST and SRRC precoding techniques in random interleaved OFDMA system using QPSK.

Fig. 6 illustrates the comparison of CCDF of PAPR of the different precoded RI-OFDMA system with conventional RI-OFDMA system using 16QAM modulation. At $CCDF=10^{-3}$, the PAPR is 10.3, 9.6, 8.9 and 8.3dB, for conventional RI-OFDMA system without precoding, for WHT precoded RI-OFDMA system, for DST precoded system and for SRRC precoded RI-OFDMA system, respectively. It can be observed that at $PAPR_0 = 8.3$ dB, the probability of a peak for SRRC precoded RI-OFDMA system is as small as 10^{-3} . By precoding the correlation among the input sequence to IFFT is reduced and hence the PAPR get reduced.

International Journal of Advanced Research in Electrical, Electronics and Instrumentation Engineering

(An ISO 3297: 2007 Certified Organization)

Vol. 3, Issue 4, April 2014

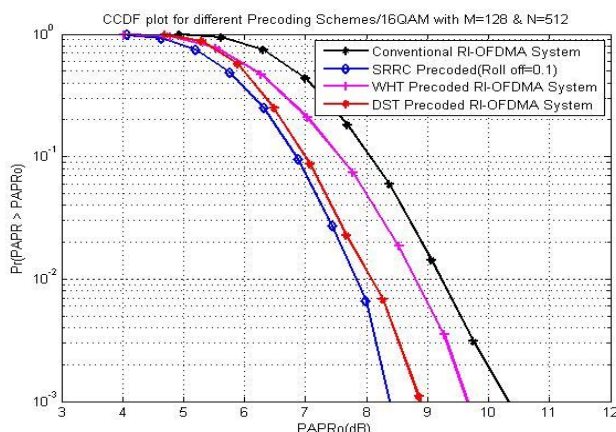

Fig.6. CCDF based comparison of PAPR of WHT, DST and SRRC precoding techniques in random interleaved OFDMA system using 16QAM.

The CCDF comparison of PAPR of the different precoded RI-OFDMA system with conventional RI-OFDMA system using 64QAM modulation is shown in Fig.7. It can be seen that, at CCDF= 10^{-3} , the PAPR is 10.1, 9.7, 9.1 and 8.5dB, for conventional RI-OFDMA system without precoding, for WHT precoded RI-OFDMA system, for DST precoded system and for SRRC precoded RI-OFDMA system, respectively. It can be observed that at PAPRo = 8.5dB, the probability of a peak for SRRC precoded RI-OFDMA system is as small as 10^{-3} .

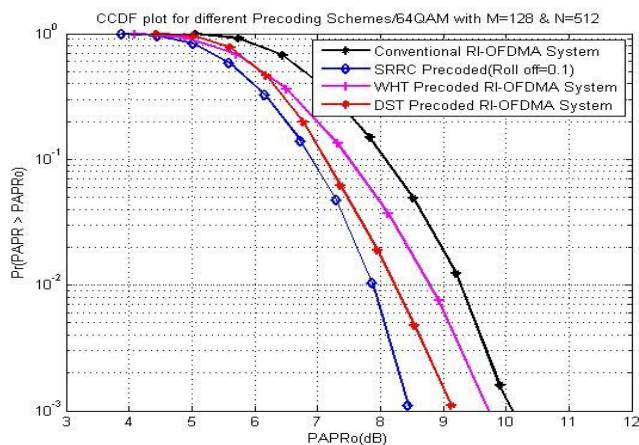

Fig.7. CCDF based comparison of PAPR of WHT, DST and SRRC precoding techniques in random interleaved OFDMA system using 64QAM.

Fig.8 provides the CCDF comparison of PAPR of the different precoded RI-OFDMA system with conventional RI-OFDMA system using 128QAM modulation. It can be seen that, at CCDF= 10^{-3} , the PAPR is 10.2, 9.8, 8.95 and 8.4dB, for conventional RI-OFDMA system without precoding, for WHT precoded RI-OFDMA system, for DST precoded system and for SRRC precoded RI-OFDMA system, respectively. It can be observed that at PAPRo = 8.4dB, the probability of a peak for SRRC precoded RI-OFDMA system is as small as 10^{-3} .

International Journal of Advanced Research in Electrical, Electronics and Instrumentation Engineering

(An ISO 3297: 2007 Certified Organization)

Vol. 3, Issue 4, April 2014

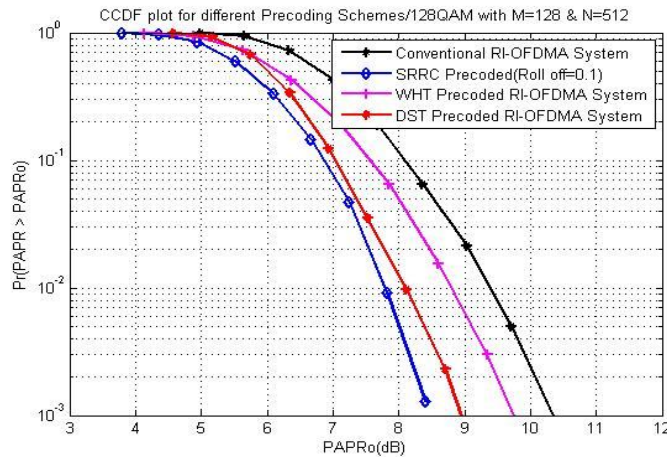

Fig.8. CCDF based comparison of PAPR of WHT, DST and SRRC precoding techniques in random interleaved OFDMA system using 128QAM.

Fig.9 provides the CCDF comparison of PAPR of the different precoded RI-OFDMA system with conventional RI-OFDMA system using 256QAM modulation. It can be seen that, at $CCDF=10^{-3}$, the PAPR is 10.1, 9.6, 9 and 8.5dB, for conventional RI-OFDMA system without precoding, for WHT precoded RI-OFDMA system, for DST precoded system and for SRRC precoded RI-OFDMA system, respectively. It is obvious that SRRC precoded RI-OFDM system provides considerable PAPR gain compared to other schemes using QAM modulation.

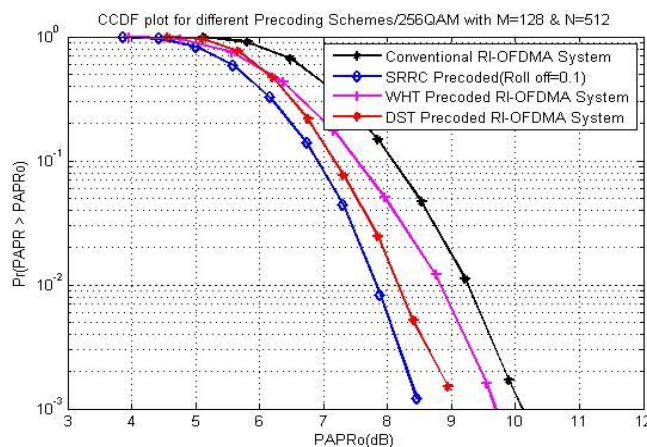

Fig.9. CCDF based comparison of PAPR of WHT, DST and SRRC precoding techniques in random interleaved OFDMA system using 256QAM.

Fig.10 illustrates the CCDF comparison of PAPR of the SRRC precoded RI-OFDMA system using various roll off factors with conventional RI-OFDMA system using 16QAM modulation. It can be seen that, the PAPR is reducing for higher roll off factors. The plot of PAPR for the RI-OFDM system without precoding and with SRRC precoding is shown in Fig.11. From the graph, it can be observed that there is a reduction in PAPR value for the precoded system when compared to the conventional system without precoding.

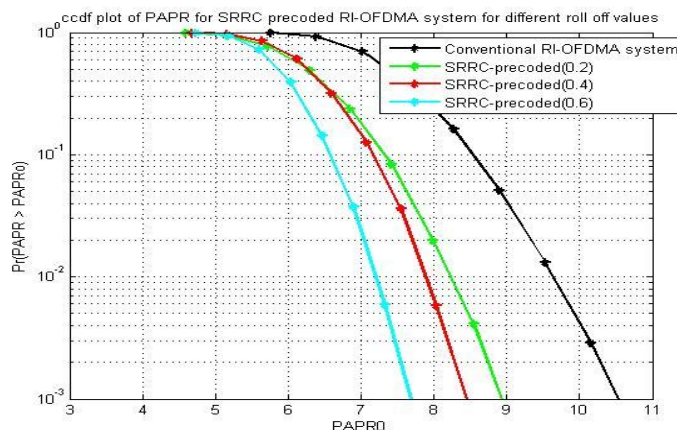

Fig.10. CCDF based comparison of PAPR of SRRC precoded RI-OFDMA with different roll-off factors.

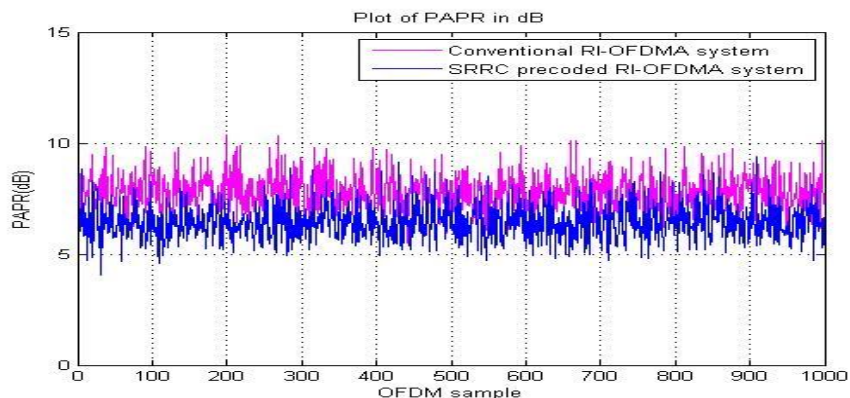

Fig.11. Comparison of PAPR of the conventional RI-OFDMA system without precoding and with SRRC precoding.

VI.CONCLUSION

In this paper, a comparative study is made on the three typical linear precoding schemes for PAPR reduction in RI-OFDMA system. Linear precoding schemes are efficient, signal independent, distortion less and do not require complex optimization when compared to the other reduction schemes. Thus in conclusion, both DST precoded systems and SRRC precoded RI-OFDMA systems are more effective than the WHT precoded and conventional RI-OFDMA system. This improvement in performance with respect to PAPR offered by the linear precoding schemes can help to reduce the cost and complexity of the Mobile WiMAX transmitters.

REFERENCES

- [1] Ahmadi, S, "An overview of next-generation mobile Wi-MAX technology", 2009 IEEE Communications Magazine, Vol. 47, Issue 6, pp. 84–98, June 2009.
- [2] J, A, C, Bingham, "Multicarrier modulation for data transmission: An idea whose time has come", IEEE Communications Magazine, vol. 28, pp. 5–14, May 1990.
- [3] L, Hanzo; M, Munster; B, J, Choi and T, Keller, "OFDM and MC-CDMA for Broadband Multi-user Communications, WLANs and Broadcasting", IEEE Press and John Wiley & Sons, Inc., 2003.
- [4] I, Koffman and V, Roman, "Broadband wireless access solutions based on OFDM access in IEEE 802.16", IEEE Communications Magazine, vol. 40, pp. 96-103, April 2002.



International Journal of Advanced Research in Electrical, Electronics and Instrumentation Engineering

(An ISO 3297: 2007 Certified Organization)

Vol. 3, Issue 4, April 2014

- [5] R. Laroia; S. Uppala and J. Li, "Designing a mobile broadband wireless access network", IEEE Signal Processing Magazine, vol. 21, pp. 20-28, September 2004.
- [6] P. Xia; S. Zhou and G. B. Giannakis, "Bandwidth and Power-efficient multicarrier multiple access", IEEE Transactions on Communications, vol. 51, pp. 1828-1837, November 2003.
- [7] T. Jiang; Y. Wu, "An overview: Peak-to-average power reduction techniques for OFDM signals " IEEE Transaction on Broadcast vol. 54, no. 2, pp. 257-268, Jun. 2008.
- [8] J. P. Panwar and Y. K. Jain, "Power Ratio Reduction with OFDM Signals for Broadband Wireless Mobile Communication", Intl. Journal of Engineering and Management Research, Vol. 4, Issue 1, pp. 66-71, Feb. 2014.
- [9] S. H. Han and J. H. Lee, "An overview of peak-to-average power ratio reduction techniques for multicarrier transmission", IEEE Wireless Communications, vol. 12, pp. 56-65, April 2005.
- [10] X. Li and L. J. Cimini, "Effects of Clipping and Filtering on the Performance of OFDM", IEEE Communication Letters, Vol.2, No.5, pp.131-133, May 1998.
- [11] J. Armstrong, "Peak-to-Average Reduction for OFDM by Repeated Clipping and Frequency Domain Filtering", IEEE Electronics Letters, Vol.38, No.5, pp.246-247, May 2002.
- [12] Lim *et al* "A new SLM OFDM scheme with low complexity for PAPR reduction", IEEE Signal Processing Letters, Vol. 12, Issue 2, pp. 93-96, Feb 2005.
- [13] Han, S. H, & Lee, J. H, " PAPR reduction of OFDM signals using a reduced complexity PTS technique", Signal Processing Letters, IEEE, Vol. 11, Issue 11, pp. 887-890, Nov. 2004.
- [14] Nikookar, H., & Lidsheim, K, S, "Random phase updating algorithm for OFDM transmission with low PAPR", 2002 IEEE Transactions on Broadcasting, Vol.48, Issue 2, pp. 123-128, Feb 2002.
- [15] Slimane Ben Slimane, "Reducing the Peak-to-Average Power ratio of OFDM Signals through Precoding", 2007 IEEE Transactions on vehicular Technology, Vol. 56, No. 2, pp.686-695, March 2007.
- [16] Miin-Jong Hao, "Precoding for PAPR Reduction of OFDM Signals With Minimum Error Probability", IEEE Transactions on Broadcasting, Vol. 56, No. 1, pp. 120-128, March 2010.
- [17] Doron Ezri and Genadiy Tsodik, "PAPR Reduction in MIMO-OFDM Using Unitary Matrix Precoding", European Wireless 2012, April 18-20, 2012.
- [18] P. Elavarasan; G. Nagarajan and A. Narayanan, "PAPR reduction in MIMO-OFDM Systems using Joint Channel Estimation and Precoding", 2012 IEEE Intl. conf. on Advaced Communication Control & Computing Technologies (ICACCCT -2012), pp. 327-331, 23-25 August 2012.
- [19] Baig, I. & Jeoti, V., "A ZCMT precoding based multicarrier OFDM system to minimize the high PAPR", Wireless Personal Communications, Vol. 68, Issue 3, pp.1135-1145, March 2013.
- [20] Imran Baig *et al*, "PAPR reduction in mobile WiMAX: a novel DST precoding based random interleaved OFDMA uplink system", Wireless networks, Nov.2013.