

Calonectria species and their *Cylindrocladium* anamorphs: species with clavate vesicles

Pedro W. Crous^{1*}, Johannes Z. Groenewald¹, Jean-Michel Risède², Philippe Simoneau³ and Kevin D. Hyde⁴

¹Centraalbureau voor Schimmelcultures, Fungal Biodiversity Centre, P.O. Box 85167, 3508 AD, Utrecht, The Netherlands; ²CIRAD-FLHOR, Station de Neufchâteau, 97130 Capesterre Belle Eau, Guadeloupe, French West Indies; ³UMR PaVé N°77- Faculté des Sciences, Université d'Angers 2, Bd Lavoisier 49045 Angers cedex, France; ⁴Centre for Research in Fungal Diversity, Department of Ecology & Biodiversity, The University of Hong Kong, Pokfulam Road, Hong Kong, SAR China

*Correspondence: Pedro W. Crous, crous@cbs.knaw.nl

Abstract: The present study compares all known species of *Cylindrocladium* that have clavate vesicles. Several isolates were obtained from baited soils collected in various parts of the world, while others were associated with leaf litter or symptomatic plant hosts. Isolates were compared based on morphology, as well as DNA sequence data from their β -tubulin and histone gene H3 regions. *Cylindrocladium australiense* and *Cy. ecuadoriae*, are described as new species, a decision based on morphology and molecular data. A group of isolates associated with toppling disease of banana in the West Indies is identified as *Cy. flexuosum*. An epitype is designated for *Cy. ilicicola*, and a new name, *Curviciadiella*, proposed to replace the anamorphic genus *Curviciadium*, which is a homonym.

Taxonomic novelties: *Cylindrocladium australiense* Crous & K.D. Hyde sp. nov., *Cylindrocladium ecuadoriae* Crous & M.J. Wingf. sp. nov., *Curviciadiella* Decock & Crous nom. nov., *Curviciadiella cigneae* (Decock & Crous) Decock & Crous comb. nov.

Key words: Ascomycetes, *Calonectria*, *Cylindrocladium*, *Hypocreales*, leaf spots, soil fungi, systematics.

INTRODUCTION

Members of the genus *Calonectria* De Not. (*Ca.*) (*Nectriaceae*, *Hypocreales*, *Ascomycetes*) and their *Cylindrocladium* Morgan (*Cy.*) anamorphs are commonly associated with a wide range of plant disease symptoms (Crous 2002). The current paper represents the second in a series assessing the taxonomy of species of *Cylindrocladium*, by integrating morphology with DNA sequence data and sexual compatibility studies (Crous *et al.* 2004).

Cylindrocladium species with clavate vesicles are well-known pathogens from a wide range of hosts in most subtropical to tropical countries (Crous & Wingfield 1992, Crous *et al.* 1995, 1997, 1999, 2000, Kang *et al.* 2001, Crous 2002). In the current study, we obtained numerous isolates of *Cylindrocladium* from baited soils collected in tropical areas. Further *Cylindrocladium* isolates were obtained from a biotic complex including root rot fungi and plant-parasitic nematodes associated with toppling disease of banana (Risède & Simoneau 2001). Previous studies have shown that isolates resembling *Cy. gracile* (Bugn.) Boesew. were pathogenic to banana, and associated with stem lesions, root breakage and toppling disease (Risède & Simoneau 2001, 2004). The aim of the present study was to analyze all available *Cylindrocladium* strains with clavate vesicles using morphology and DNA sequence analysis of their β -tubulin and histone H3 gene regions in order to resolve the status of *Cylindrocladium* species with clavate vesicles. A further aim was to identify the *Cylindrocladium* sp. associated with toppling disease of banana.

MATERIALS AND METHODS

Isolates

Isolates were obtained from plant hosts, or baited from soil as explained in Crous (2002). Cultural characteristics and morphology were determined on plates containing 2 % malt extract agar (MEA) (20 g/L), and carnation leaf agar (CLA) [1 % water agar (10 g/L) with autoclaved carnation leaves placed onto the medium] in the other (Gams *et al.* 1998). Plates were incubated for 7 d at 25 °C under continuous near-UV light, to promote sporulation.

DNA phylogeny

Genomic DNA was isolated from fungal mycelia collected from the plates using the isolation protocol of Lee & Taylor (1990). Two loci were amplified and sequenced as explained in Crous *et al.* (2004), namely, part of the β -tubulin gene, amplified with primers T1 (O'Donnell & Cigelnik 1997) and CYLTUB1R (Crous *et al.* 2004); and part of the histone H3 gene using primers CYLH3F and CYLH3R (Crous *et al.* 2004).

The sequences generated in this study were added to other sequences obtained from GenBank (<http://www.ncbi.nlm.nih.gov>) and TreeBASE (<http://www.treebase.org>) and the alignment was assembled using Sequence Alignment Editor v. 2.0a11 (Rambaut 2002) with manual adjustments for improvement made visually where necessary. Sequences for *Cylindrocladiella peruviana* (Bat., J.L. Bezerra & M.M.P. Herrera) Boesew. and *Cylindrocladiella lageniformis* Crous, M.J. Wingf. & Alfenas were added to the alignments as outgroups.

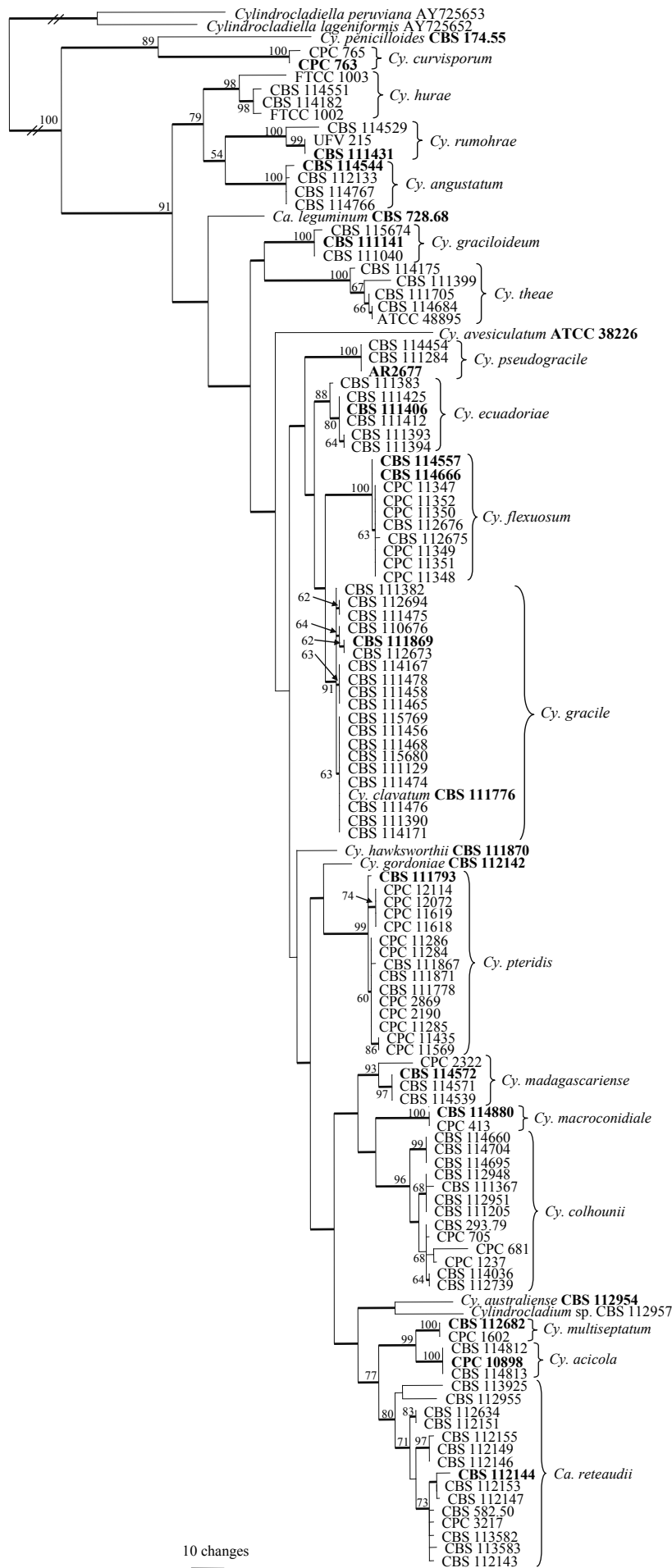

Fig. 1. One of 657 most parsimonious trees obtained from a heuristic search with 100 random taxon additions of the β -tubulin sequence alignment. The scale bar shows 10 changes and bootstrap support values from 1000 replicates are shown at the nodes. Thickened lines indicate branches present in the strict consensus tree. The tree was rooted to two *Cyandrocladiella* species.

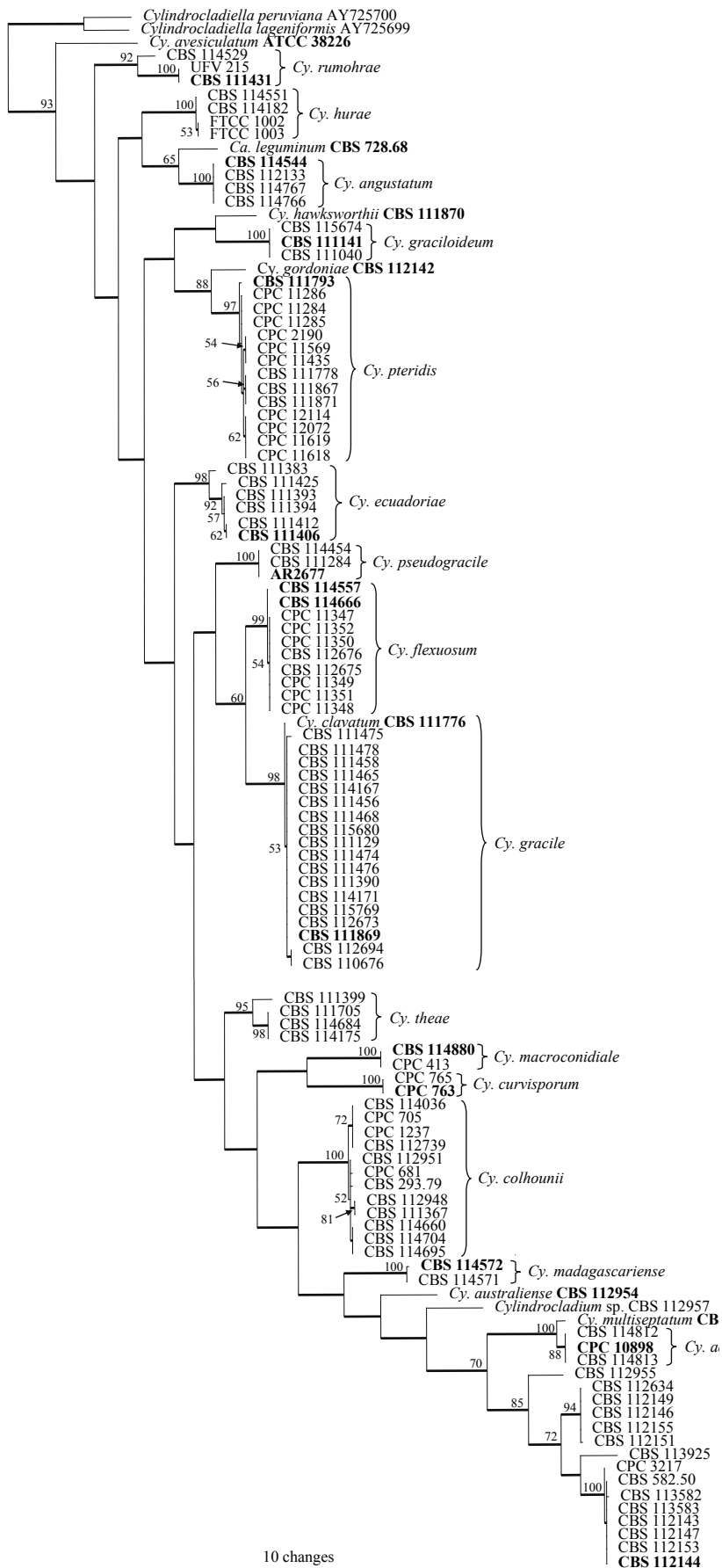

Fig. 2. One of four most parsimonious trees obtained from a heuristic search with 100 random taxon additions of the histone H3 sequence alignment. The scale bar shows 10 changes and bootstrap support values from 1000 replicates are shown at the nodes. Thickened lines indicate branches present in the strict consensus tree. The tree was rooted to two *Cyandrocladiella* species.

Table 1. Isolates of *Cylindrocladium* (*Calonectria*) species studied.

Species	Isolate number ^{1,2}	β-tubulin ³	Histone H3 ³	Host	Country	Collector	
<i>Ca. avesiculata</i> (<i>Cy. avesiculatum</i>)	ATCC 38226; CPC 2373 ^T	AF333392	DQ190620	<i>Ilex vomitoria</i>	U.S.A.	S.A. Alfieri	
	CBS 112675; SLU2	DQ190547	DQ190621	<i>Musa</i> sp.	Saint Lucia	J.M. Risède	
<i>Ca. clavata</i> (<i>Cy. flexuosum</i>)	CBS 112676; Gua9	DQ190548	DQ190622	<i>Musa</i> sp.	Guadeloupe	J.M. Risède	
	CBS 114557; CPC 2536 ^T	AF333396	DQ190623	<i>Callistemon viminalis</i>	U.S.A.	N.E. El-Gholl	
	CBS 114666; CPC 2537 ^T	DQ190549	DQ190624	–	U.S.A.	N.E. El-Gholl	
	CPC 11347; Mar8	DQ190550	DQ190625	<i>Musa</i> sp.	Martinique	J.M. Risède	
	CPC 11348; Mar23	DQ190551	DQ190626	<i>Musa</i> sp.	Martinique	J.M. Risède	
	CPC 11349; Mar11	DQ190552	DQ190627	<i>Musa</i> sp.	Martinique	J.M. Risède	
	CPC 11350; SLU5	DQ190553	DQ190628	<i>Musa</i> sp.	Saint Lucia	J.M. Risède	
	CPC 11351; Gua12	DQ190554	DQ190629	<i>Musa</i> sp.	Saint Lucia	J.M. Risède	
	CPC 11352	DQ190555	DQ190630	<i>Musa</i> sp.	Martinique	J.M. Risède	
	<i>Ca. colhoumii</i> (<i>Cy. colhoumii</i>)	CBS 111205; CPC 1330	DQ190556	–	–	Indonesia	M.J. Wingfield
		CBS 111367; CPC 1339	AF232851	DQ190631	<i>Eucalyptus</i> sp.	Indonesia	M.J. Wingfield
		CBS 112739; CPC 4082	DQ190557	DQ190632	<i>Eucalyptus grandis</i>	U.S.A.	M.J. Wingfield
CBS 112948; CPC 4669		DQ190558	DQ190633	–	U.S.A.	–	
CBS 112951; CPC 4717		DQ190559	DQ190634	<i>Eleaocarpus angustifolius</i>	Australia	C. Pearce & B. Paulus	
CBS 114036; CPC 10718		DQ190560	DQ190635	<i>Rhododendron</i> sp.	U.S.A.	C.S. Hodges	
CBS 114660; CPC 2407		DQ190561	DQ190636	<i>Arachis pintoi</i>	Australia	D. Hutton	
CBS 114695; CPC 2424		DQ190562	DQ190637	<i>A. pintoi</i>	Australia	D. Hutton	
CBS 114704; CPC 2422		DQ190563	DQ190638	<i>A. pintoi</i>	Australia	D. Hutton	
CBS 293.79		DQ190564	DQ190639	–	Indonesia	–	
CPC 681		AF232852	DQ190640	Soil	Thailand	M.J. Wingfield	
CPC 705		AF232854	DQ190641	Soil	South Africa	M.J. Wingfield	
<i>Ca. gracilipes</i> (<i>Cy. graciloideum</i>)	CPC 1237	AF232853	DQ190642	<i>Eucalyptus</i> sp.	South Africa	M.J. Wingfield	
	CBS 111040; CPC 1159	DQ190565	DQ190643	–	Colombia	M.J. Wingfield	
	CBS 111141; CPC 1211 ^T	DQ190566	DQ190644	<i>Eucalyptus</i> sp.	Colombia	M.J. Wingfield	
	CBS 115674; CPC 1153	AF333406	DQ190645	Soil	Colombia	M.J. Wingfield	
	AR2677 ^T	AF232858	DQ190646	<i>Manilkara</i> sp.	Brazil	–	
	CBS 111284; CPC 1483	DQ190567	DQ190647	–	Brazil	P.W. Crous	
<i>Ca. gracilis</i> (<i>Cy. pseudogracile</i>)	CBS 114454; CPC 1588	AF232864	DQ190648	Soil	Brazil	P.W. Crous	
	CBS 111870; MUCL 30866; CPC 2405 ^T	AF333407	DQ190649	–	Mauritius	A. Peerally	
	ATCC 48895; CPC 2383	AF232861	–	<i>Rhododendron</i> cv. Kingfisher	U.S.A.	–	
<i>Ca. indusiata</i> (<i>Cy. theae</i>)	CBS 111399; CPC 1620	DQ190568	DQ190650	–	Ecuador	M.J. Wingfield	

Table 1. (Continued).

Species	Isolate number ^{1,2}	β -tubulin ³	Histone H3 ³	Host	Country	Collector
<i>Ca. leguminum</i> (<i>Cy. leguminum</i>) <i>Ca. macroconidialis</i> (<i>Cy. macroconidiale</i>)	CBS 111705; CPC 1713	DQ190569	DQ190651	<i>Rumohra adiantiformis</i>	U.S.A.	J.Y. Uchida
	CBS 114175; CPC 1712	DQ190570	DQ190652	<i>Strelitzia nicotaii</i>	U.S.A.	J.Y. Uchida
	CBS 114684; UFV 16A; CPC 2446	AF232862	DQ190653	<i>Rhododendron</i> sp.	U.S.A.	N.E. El-Gholl
	CBS 728.68; IMI 299578 ^T	AF389837	DQ190654	–	–	M.B. Figueiredo
	CBS 114880; CPC 307 ^T	AF232855	DQ190655	<i>Eucalyptus grandis</i>	South Africa	P.W. Crous
	CPC 413	AF232856	DQ190656	<i>Eucalyptus</i> sp.	South Africa	P.W. Crous
	CBS 114539; CPC 2321	AF333416	–	Soil	Madagascar	J.E. Taylor
	CBS 114571; CPC 2253	DQ190571	DQ190657	–	Madagascar	P.W. Crous
	CBS 114572; CPC 2252 ^T	DQ190572	DQ190658	–	Madagascar	P.W. Crous
	CPC 2322	AF333417	–	Soil	Congo	J. Roux
<i>Ca. multiseptata</i> (<i>Cy. multiseptatum</i>) <i>Ca. reteaudii</i> (<i>Cy. reteaudii</i>)	CBS 112682; CPC 1589 ^T	DQ190573	DQ190659	<i>Eucalyptus</i> sp.	Indonesia	M.J. Wingfield
	CPC 1602; CMW 4054	AF210866	–	<i>Eucalyptus</i> sp.	Indonesia	M.J. Wingfield
	CBS 112143; CPC 3200	DQ190574	DQ190660	<i>Eucalyptus</i> sp.	Vietnam	M.J. Dudzinski & P.Q. Thu
	CBS 112144; CPC 3201 ^T	AF389833	DQ190661	<i>E. camaldulensis</i>	Vietnam	M.J. Dudzinski & P.Q. Thu
	CBS 112146; CPC 3213	AF389835	DQ190662	<i>E. urophylla</i>	Australia	B. Brown
	CBS 112147; CPC 3214	AF389830	DQ190663	<i>E. camaldulensis</i>	Vietnam	M.J. Dudzinski & P.Q. Thu
	CBS 112149; CPC 3216	AF389832	DQ190664	<i>E. urophylla</i>	Australia	M. Ramsden
	CBS 112151; CPC 3202	DQ190575	DQ190665	<i>E. urophylla</i>	Australia	C. Hanwood
	CBS 112153; CPC 3205	AF389831	DQ190666	<i>E. camaldulensis</i>	Vietnam	M.J. Dudzinski & P.Q. Thu
	CBS 112155; CPC 3210	AF389834	DQ190667	<i>E. pellita</i>	Australia	P.Q. Thu & K.M. Old
<i>Ca. rumohrae</i> (<i>Cy. rumohrae</i>) <i>Cy. penicilloides</i> <i>Ca. pteridis</i> (<i>Cy. pteridis</i>)	CBS 112634; CPC 4233	DQ190576	DQ190668	<i>Xanthorrhoea australis</i>	Australia	T. Baigent
	CBS 112955; CPC 4716	DQ190577	DQ190669	<i>Ficus pleurocarpa</i>	Australia	C. Pearce & B. Paulus
	CBS 113582; CPC 516	AF389846	DQ190670	<i>Eucalyptus</i> sp.	Thailand	M.J. Wingfield
	CBS 113583; CPC 759	AF389847	DQ190671	<i>Eucalyptus</i> sp.	Madagascar	P.W. Crous
	CBS 113925; ATCC 16550; IMI 114953; CPC 2366	AF389843	DQ190672	<i>Scolopendrium</i> sp.	–	–
	CBS 582.50; CPC 3701	AF389836	DQ190673	Seedling of <i>Hibiscus sabdariffa</i>	Indonesia	K.B. Boedijn & J. Reitsma
	CPC 3217	AF389829	DQ190674	<i>E. camaldulensis</i>	Vietnam	M.J. Dudzinski & P.Q. Thu
	CBS 111431; UFV 218; CPC 1716 ^T	AF232871	DQ190675	<i>Rumohra adiantiformis</i>	Panama	A.C. Alfenas
	CBS 114529; CPC 1603	AF232873	DQ190676	<i>Adiantum</i> sp.	Netherlands	R. Pieters
	UFV 215; CPC 1831	AF232872	DQ190677	<i>Rumohra adiantiformis</i>	Panama	A.C. Alfenas
CBS 174.55; CPC 2388 ^T	AF333414	–	<i>Prunus</i> sp.	Japan	Tubaki	
CBS 111778; UFV 43; CPC 2451	AF232859	DQ190678	–	Brazil	J.C. Dianese	

Table 1. (Continued).

Species	Isolate number ^{1,2}	β -tubulin ³	Histone H3 ³	Host	Country	Collector
	CBS 111793; ATCC 34395; CPC 2372 ^T	DQ190578	DQ190679	<i>Arachnoides adiantiformis</i>	U.S.A.	–
	CBS 111867; CPC 2447	DQ190579	DQ190680	<i>Pinus caribaea</i>	Spain	T.L. Krugner
	CBS 111871; UFV 10-A; CPC 2443	DQ190580	DQ190681	<i>Pinus</i> sp.	Spain	T.L. Krugner
	CPC 2190	AF232860	DQ190682	<i>Eucalyptus</i> sp.	Brazil	P.W. Crous
	CPC 2869	AF333415	–	<i>Eucalyptus</i> sp.	Brazil	P.W. Crous
	CPC 11284	DQ190581	DQ190683	<i>E. grandis</i>	Brazil	A.C. Alfenas
	CPC 11285	DQ190582	DQ190684	<i>E. grandis</i>	Brazil	A.C. Alfenas
	CPC 11286	DQ190583	DQ190685	<i>E. grandis</i>	Brazil	A.C. Alfenas
	CPC 11435	DQ190584	DQ190686	<i>Eucalyptus</i> sp.	Brazil	A.C. Alfenas
	CPC 11569	DQ190585	DQ190687	<i>Eucalyptus</i> sp.	Brazil	A.C. Alfenas
	CPC 11618	DQ190586	DQ190688	<i>Tillandsia wagneriana</i>	Netherlands	C.F. Hill
	CPC 11619	DQ190587	DQ190689	<i>Guzmania wittmackii</i>	Netherlands	C.F. Hill
	CPC 12072	DQ190588	DQ190690	–	New Zealand	C.F. Hill
	CPC 12114	DQ190589	DQ190691	<i>Drosera</i> sp.	Netherlands	J. Dijksterhuis
<i>Cy. acicola</i>	CBS 114812	DQ190590	DQ190692	Diffuse leaf lesions of <i>Phoenix canariensis</i>	New Zealand	H. Pearson
	CBS 114813	DQ190591	DQ190693	Diffuse leaf lesions of <i>P. canariensis</i>	New Zealand	H. Pearson
	CPC 10898T	DQ190592	DQ190694	<i>Pinus</i> sp.	New Zealand	M. Dick
<i>Cy. angustatum</i>	CBS 112133; P99-1321; CPC 3152	DQ190593	DQ190695	<i>Tillandsia capitata</i>	U.S.A.	R.M. Leahy
	CBS 114544; P99-0454; CPC 2347 ^T	AF207543	DQ190696	<i>T. capitata</i>	U.S.A.	N.E. El-Gholl
	CBS 114766; CPC 4522	DQ190594	DQ190697	<i>T. tricolor</i>	Guatemala	C.F. Hill
	CBS 114767; CPC 4523	DQ190595	DQ190698	<i>T. tricolor</i>	Guatemala	C.F. Hill
<i>Cy. australiense</i>	CBS 112954; CPC 4714 ^T	DQ190596	DQ190699	<i>Ficus pleurocarpa</i>	Australia	C. Pearce & B. Paulus
<i>Cy. clavatum</i> (synonym of <i>Cy. gracile</i>)	CBS 111776; ATCC 22833; CPC 2479 ^T	AF232850	DQ190700	<i>Pinus caribaea</i>	Brazil	C.S. Hodges
<i>Cy. curvisporum</i>	CPC 763 ^T	AF333394	DQ190701	Soil	Madagascar	P.W. Crous
	CPC 765	AF333395	AY725664	Soil	Madagascar	P.W. Crous
	CBS 111383; CPC 1587	DQ190597	DQ190702	Soil	Brazil	P.W. Crous
<i>Cy. ecuadoriae</i>	CBS 111393; CPC 1627	DQ190598	DQ190703	Soil	Ecuador	M.J. Wingfield
	CBS 111394; CPC 1628	DQ190599	DQ190704	Soil	Ecuador	M.J. Wingfield
	CBS 111406; CPC 1635 ^T	DQ190600	DQ190705	Soil	Ecuador	M.J. Wingfield
	CBS 111412; CPC 1648	DQ190601	DQ190706	Soil	Ecuador	M.J. Wingfield
	CBS 111425; CPC 1657	DQ190602	DQ190707	Soil	Ecuador	M.J. Wingfield
<i>Cy. gordoniae</i>	CBS 112142; ATCC 201837; CPC 3136 ^T	AF449449	DQ190708	<i>Gordonia lasianthus</i>	U.S.A.	D. Chiappini
<i>Cy. gracile</i>	CBS 110676; CPC 623	AF333405	DQ190709	Soil	Brazil	M.J. Wingfield

Table 1. (Continued).

Species	Isolate number ^{1,2}	β -tubulin ³	Histone H3 ³	Host	Country	Collector
	CBS 111129; CPC 921	DQ190603	DQ190710	Soil	Brazil	M.J. Wingfield
	CBS 111382; CPC 1586	AF232863	-	Soil	Brazil	P.W. Crous
	CBS 111390; CPC 1616	DQ190604	DQ190711	Soil	Ecuador	M.J. Wingfield
	CBS 111456; CPC 1918	DQ190605	DQ190712	Soil	Brazil	A.C. Alfenas
	CBS 111458; CPC 1910	DQ190606	DQ190713	Soil	Brazil	A.C. Alfenas
	CBS 111465; CPC 1902	DQ190607	DQ190714	Soil	Brazil	A.C. Alfenas
	CBS 111468; CPC 1905	DQ190608	DQ190715	Soil	Brazil	A.C. Alfenas
	CBS 111474; CPC 1908	DQ190609	DQ190716	Soil	Brazil	A.C. Alfenas
	CBS 111475; IMI 167580; CPC 1967	AF333404	DQ190717	<i>Camellia sinensis</i>	Mauritius	A. Peeraly
	CBS 111476; CPC 1909	DQ190610	DQ190718	Soil	Brazil	A.C. Alfenas
	CBS 111478; CPC 1921	DQ190611	DQ190719	Soil	Brazil	A.C. Alfenas
	CBS 111869; PC 551197; CPC 2409 ^T	AF232857	DQ190720	<i>Argyrea</i> sp.	South East Asia	-
	CBS 112673; Cam14	DQ190612	DQ190721	<i>Musa</i> sp.	Cameroon	J.M. Abadie
	CBS 112694; CPC 617	DQ190613	DQ190722	Soil	Brazil	M.J. Wingfield
	CBS 114167; CPC 1912	DQ190614	DQ190723	Soil	Brazil	A.C. Alfenas
	CBS 114171; CPC 1891	DQ190615	DQ190724	Soil	Brazil	A.C. Alfenas
	CBS 115680; CPC 922	DQ190616	DQ190725	Soil	Brazil	M.J. Wingfield
	CBS 115769; CPC 920	DQ190617	DQ190726	Soil	Brazil	M.J. Wingfield
<i>Cy. hurae</i>	CBS 114182; UFV 216; CPC 1714	DQ190618	DQ190727	<i>Rumohra adiantiformis</i>	Brazil	A.C. Alfenas
	CBS 114551; CPC 2344	AF333408	DQ190728	<i>R. adiantiformis</i>	U.S.A.	N.E. El-Gholl
	FTCC 1002; CPC 2395	AF232866	DQ190729	<i>R. adiantiformis</i>	U.S.A.	N.E. El-Gholl
	FTCC 1003; CPC 2419	AF232867	DQ190730	<i>R. adiantiformis</i>	U.S.A.	N.E. El-Gholl
<i>Cylindrocladium</i> sp.	CBS 112957; CPC 4710	DQ190619	DQ190731	<i>Eleaeocharpus angustifolius</i>	Australia	I. Steer & B. Paulus

¹CBS: Centraalbureau voor Schimmelcultures, Utrecht, The Netherlands □
Lane, U.K.; ATCC: American Type Culture Collection, Virginia, U.S.A.; UFV: Universidade Federal de Viçosa, Brazil; CMW: Mike Wingfield collection housed at FABI, Pretoria, South Africa; FTCC: Food Technology Culture Collection, Malaysian Agricultural Research and Development Institute, Food Technology Centre, MARDI, GPO Box 12301, Kuala Lumpur, 50774, Malaysia; MUCL: Mycotheque de l'Université Catholique de Louvain, Louvain-la-Neuve, Belgium; PC: Laboratoire de Cryptogamie, Paris, France.

²All ex-type cultures are indicated with a superscript "T".

³GenBank accession numbers.

The phylogenetic analyses of sequence data were done using PAUP (Phylogenetic Analysis Using Parsimony) v. 4.0b10 (Swofford 2002). Phylogenetic analysis of both datasets in PAUP consisted of distance (using the uncorrected "p", Jukes-Cantor and HKY85 substitution models) and parsimony analysis as described in Crous *et al.* (2004). Sequences were deposited in GenBank (Table 1) and the alignments in TreeBASE (S1508, M2711).

Taxonomy

Morphological examinations were made from cultures sporulating on CLA. Structures were mounted in lactic acid, and 30 measurements at $\times 1000$ magnification were made of each structure. The 95 % confidence levels were determined, and the extremes of spore measurements given in parentheses. Colony reverse colours were noted after 6 d on MEA at 25 °C in the dark, using the colour charts of Rayner (1970) for comparison. All cultures studied are maintained in the culture collection of the Centraalbureau voor Schimmelcultures (CBS), Utrecht, the Netherlands (Table 1).

RESULTS

DNA phylogeny

Approximately 550 bases of the β -tubulin gene were determined for the isolates indicated in Table 1. The manually adjusted alignment contained 123 isolates (including the two outgroups) and 533 characters including alignment gaps. Of these characters, 220 were parsimony-informative, 60 were variable and parsimony-uninformative, and 253 were constant. Neighbour-joining analysis using the three substitution models, as well as parsimony analysis, yielded trees in which the same clades were supported. In some analyses, for example between the uncorrected "p" and HKY85 substitution models, the basal order of the clades were different (data not shown). Parsimony analysis of the alignment yielded 657 most parsimonious trees (TL = 881 steps; CI = 0.529; RI = 0.853; RC = 0.451), one of which is shown in Fig. 1. Most of these trees resulted from the reordering of taxa within the *Cy. colhounii* Peerally and *Ca. reteaudii* (Bugn.) C. Booth clades. All taxa from the same species clustered in well-supported clades, namely *Cy. curvisporum* Crous & D. Victor (100 % bootstrap support), *Cy. hurae* (Linder & Whetzel) Crous (98 %), *Cy. rumohrae* El-Gholl & Alfenas (100 %), *Cy. angustatum* Crous & El-Gholl (100 %), *Cy. graciloideum* Crous & M.R.A. Mchau (100 %), *Cy. theae* (Petch.) Subram. (100 %), *Cy. pseudogracile* Crous (100 %), *Cy. ecuadoriae* Crous & M.J. Wingf. (88 %), *Cy. flexuosum* Crous (100 %), *Cy. gracile* (Bugn.) Boesew. (91 %), *Cy. pteridis* F.A. Wolf (99 %), *Cy. madagascariense* Crous (93 %), *Cy. macroconidiale* (Crous, M.J. Wingf. & Alfenas) Crous (100 %), *Cy. colhounii* (96 %), *Cy. multiseptatum* Crous & M.J. Wingf. (100 %), *Cy. acicola* Gadgil & M. Dick (100 %) and *Ca. reteaudii* (80 %). All species represented by a

single taxon were placed as unsupported sister taxa to the other clades in the tree. The only exception was *Cy. penicilloides* (Tubaki) Tubaki, which grouped with the *Cy. curvisporum* clade with a bootstrap support value of 89 %. Association with support values were also observed between some clades, for example the clades containing *Cy. hurae*, *Cy. rumohrae* and *Cy. angustatum* grouped with a bootstrap support value of 79 %.

Approximately 480 bases of the histone gene were determined for the isolates in Table 1. The manually adjusted alignment contained 115 isolates (including the two outgroups), and for each taxon 425 characters including alignment gaps were analysed. Of these characters, 168 were parsimony-informative, 9 were variable and parsimony-uninformative, and 248 were constant. Neighbour-joining analysis using the three substitution models, as well as parsimony analysis, yielded trees in which the same clades were supported. For distance analysis, the Jukes-Cantor and HKY85 substitution models yielded trees with identical topologies, but the tree obtained from the uncorrected "p" model had rearrangements at the deep nodes when compared with the other two trees (data not shown). Parsimony analysis of the alignment yielded four most parsimonious trees (TL = 917 steps; CI = 0.382; RI = 0.868; RC = 0.331), one of which is shown in Fig. 2. All of these trees resulted from reordering of taxa within the *Cy. colhounii* clade. As with the β -tubulin tree, taxa from the same species clustered together in well-supported clades (Fig. 2). Clade order was not supported at the deeper nodes.

Taxonomy

Calonectria clavata Alfieri, El-Gholl & E.L. Barnard, Mycotaxon 48: 206. 1993.

Anamorph: Cyindrocladium flexuosum Crous, Syst. Appl. Microbiol. 18: 248. 1995.

Macroconidiophores consisting of a stipe, a penicillate arrangement of fertile branches, a stipe extension, and a terminal vesicle; stipe septate, pale brown at base, hyaline, smooth, septate, 60–260 \times 5–7 μ m; stipe extensions septate, straight to flexuous, 120–450 μ m long, 3–4 μ m wide at apical septum, terminating in a narrowly clavate vesicle, 4–5 μ m diam. *Conidiogenous apparatus* 70–120 μ m long, 25–60 μ m wide; primary branches aseptate or 1-septate, 30–65 \times 4–6 μ m; secondary branches aseptate or 1-septate, 30–50 \times 3–6 μ m, tertiary and quaternary branches aseptate, 15–30 \times 3–5 μ m, each terminal branch producing 1–4 phialides; phialides elongate doliiform to reniform, hyaline, aseptate, 10–20 \times 4–5 μ m, apex with minute periclinal thickening and inconspicuous collarete. *Conidia* cylindrical, rounded at both ends, straight, (55–)68–75(–95) \times (5–)6(–7) μ m (av. = 70 \times 6 μ m), 1-septate (but up to 5-septate at germination), lacking a visible abscission scar, held in parallel cylindrical clusters by colourless slime (description based on isolates obtained from *Musa*).

Specimens examined: U.S.A. Florida, Lake Placid, roots and stems of *Callistemon viminalis*, 5 Apr. 1978, C.P. Seymour & E.L. Barnard,

PREM 51721 **holotype** of *Cy. flexuosum*, P078-1543 = ATCC 66389 = STE-U 2536 = CBS 114557 culture ex-type, heterothallic mating with P078-1261 = STE-U 2537 = CBS 114666, Florida, Lee County, root debris in non-sterilized peat, 4 Mar. 1978, D. Ferrin, Aug. 1989, N.E. El-Gholl, FLAS F55430, **holotype** of *Ca. clavata*. **Guadeloupe**, *Musa* sp., J.M. Risède & Ph. Simoneau, Gua12 = CPC 11351, CPC 11352 = CBS 119338, Gua9 = CBS 112676. **Martinique**, *Musa* sp., J.M. Risède & Ph. Simoneau, Mar11 = CPC 11349 = CBS 119336, Mar23 = CPC 11348 = CBS 119335, Mar8 = CPC 11347 = CBS 119334. **Saint Lucia**, *Musa* sp., SLU2 = CBS 112675, SLU5 = CPC 11350 = CBS 119337.

Cultural characteristics: See Crous (2002).

Substrates and distribution: *Musa* spp., Guadeloupe, Martinique, Saint Lucia; *Callistemon viminalis*, and root debris in peat U.S.A. (Florida) (Crous 2002).

Notes: *Cylindrocladium flexuosum* is known to have conidia that are straight to curved, (44–)50–70(–80) × (4–)5–6 µm (av. = 65 × 5 µm) and 1(–3)-septate. The isolates obtained from *Musa* differ from the ex-type strains by having conidia that are up to 7 µm wide. Although we originally suspected the *Musa* isolates to represent an undescribed taxon, they clustered in the same clade as those of *Cy. flexuosum*. None of the isolates were able to mate, and since its original description, it has not proven possible to reproduce perithecia of *Calonectria clavata* in culture.

Cylindrocladium australiense Crous & K.D. Hyde, **sp. nov.** MycoBank MB500864. Figs 3–4.

Etymology: Named after the country from which it was collected.

Cylindrocladio colhounii simile sed conidiis latoribus, (48–)57–68(–75) × (6–)6.5(–7) µm, distinguendum.

Teleomorph unknown. **Conidiophores** consisting of a stipe bearing a penicillate arrangement of fertile branches, a stipe extension, and a terminal vesicle; stipe septate, hyaline, smooth, 60–150 × 6–7 µm; stipe extensions septate, straight to flexuous, 300–450 µm long, 2.5–3 µm wide at the apical septum, terminating in a clavate vesicle, (3.5–)5(–6) µm diam. **Conidiogenous apparatus** 40–80 µm long, and 40–60 µm wide; primary branches aseptate or 1-septate, 15–30 × 5–7 µm; secondary branches aseptate, 12–20 × 5–6 µm, tertiary and additional branches (–6), aseptate, 10–15 × 5–6 µm, each terminal branch producing 1–4 phialides; phialides cylindrical to allantoid, hyaline, aseptate, 10–15 × 3.5–4.5 µm; apex with minute periclinal thickening and inconspicuous collarette. **Conidia** cylindrical, rounded at both ends, straight, (48–)57–68(–75) × (6–)6.5(–7) µm (av. = 63 × 6.5 µm), (1–)3-septate, lacking a visible abscission scar,

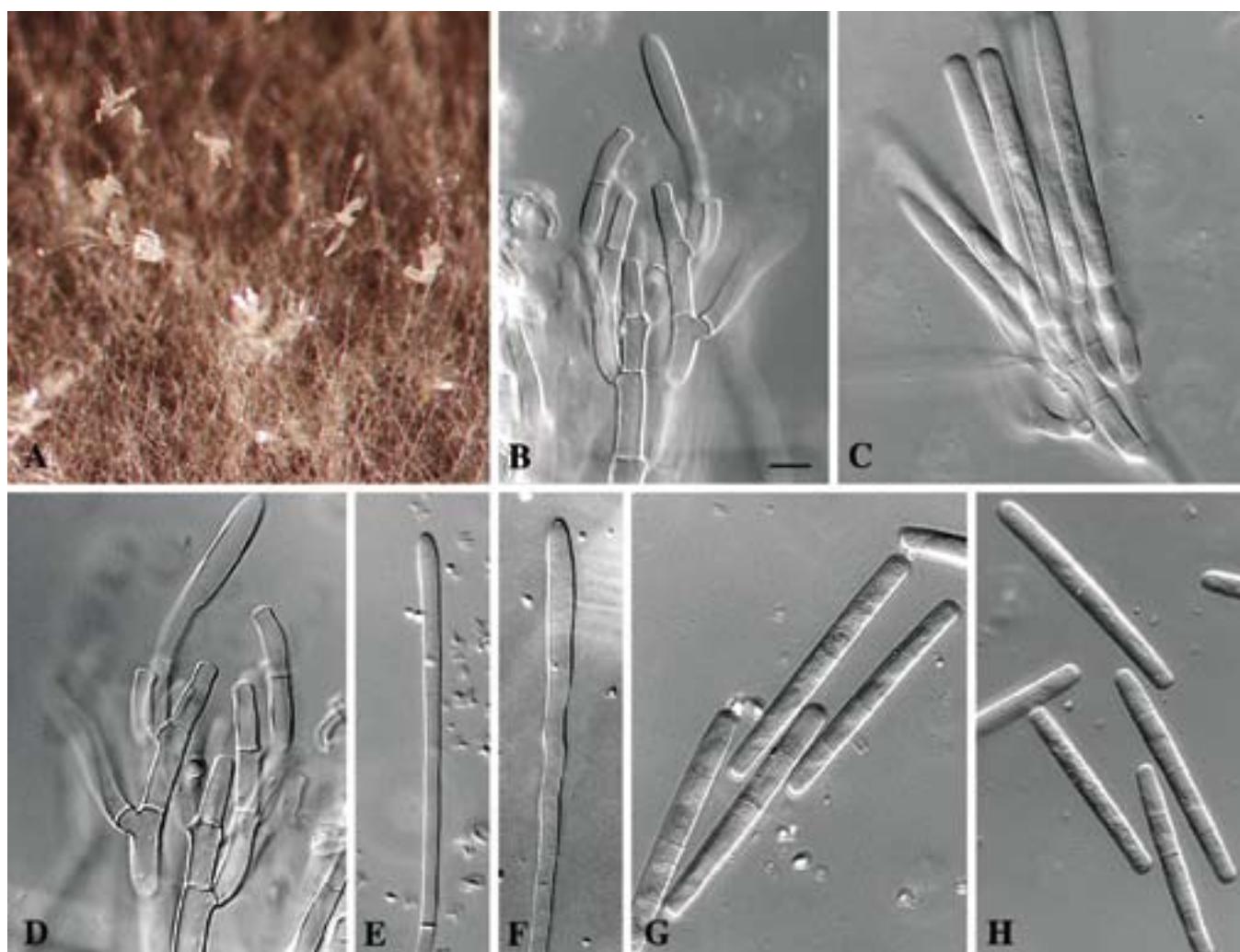

Fig. 3. *Cylindrocladium australiense*. A. Sporulation on MEA. B–D. Conidiophores on CLA. E–F. Clavate vesicles. G–H. Three-septate conidia. Scale bar = 10 µm.

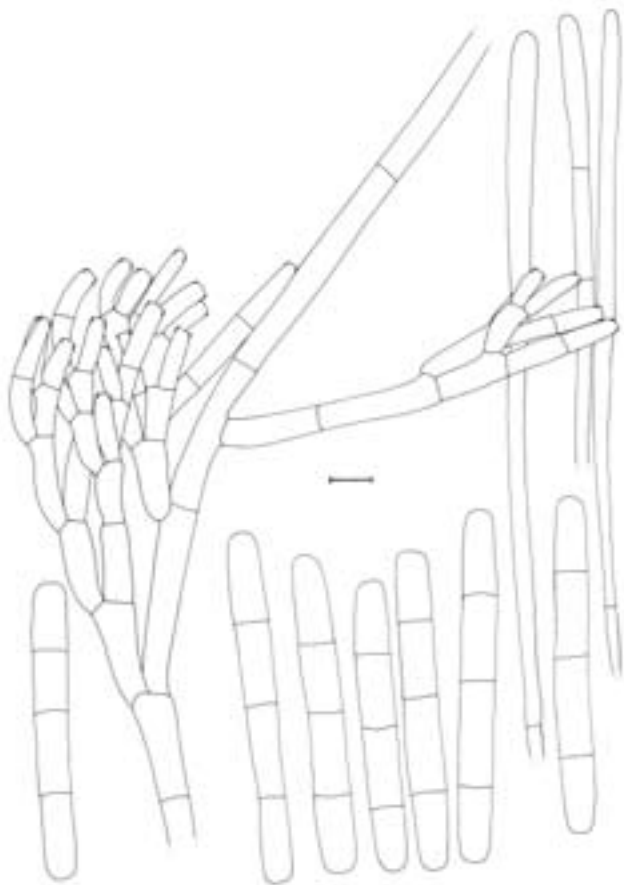

Fig. 4. *Cylindrocladium australiense*. Penicillate conidiophore, clavate vesicles and conidia. Scale bar = 10 μ m.

held in parallel cylindrical clusters by colourless slime. *Megaconidia* and *microconidia* unknown.

Specimen examined: **Australia**, Queensland, Topaz, Atherton Tablelands, *Ficus pleurocarpa*, 2 Apr. 2001, C. Pearce & B. Paulus, **holotype** CBS H-17872, culture ex-type CBS 112954 = CPC 4714.

Cultural characteristics: Colonies fast growing with abundant white aerial mycelium; surface and reverse sienna (13i), with moderate numbers of chlamydospores.

Substrate: *Ficus pleurocarpa*.

Distribution: Australia.

Notes: This species can be confused with taxa in the *Cylindrocladium colhounii* Peerally species complex that form 3-septate conidia of similar dimensions, and yellow *Calonectria* perithecia. It can be distinguished by having wider conidia (48–)57–68(–75) \times (6–)6.5(–7) μ m than *Cy. colhounii* [(45–)60–70(–80) \times (4–)5(–6) μ m], and *Cy. madagascariense* Crous [(42–)52–58(–65) \times (3.5–)4–5 μ m]. Another species that needs to be compared to *Cy. australiense* is *Cy. theae* (Petch) Subram., which again has larger conidia (65–)70–88(–96) \times 5–6(–7) μ m, and also forms megaconidia and a *Calonectria* teleomorph with red perithecia in culture (Crous 2002).

Cylindrocladium ecuadoriae Crous & M.J. Wingf., **sp. nov.** MycoBank MB500865. Figs 5–6.

Etymology: Named after Ecuador, where it appears quite commonly in soil.

Cylindrocladio gracili simile, sed conidiis angustioribus, (45–)48–55(–65) \times (4–)4.5(–5) μ m, distinguendum.

Teleomorph unknown. **Conidiophores** consisting of a stipe bearing a penicillate arrangement of fertile branches, a stipe extension, and a terminal vesicle; stipe septate, hyaline, smooth, 60–100 \times 5–7 μ m; stipe extensions septate, straight to flexuous, 200–300 μ m long, 2–3 μ m wide at the apical septum, terminating in a clavate vesicle, (3–)4(–5) μ m diam. **Conidiogenous apparatus** 30–100 μ m long and wide; primary branches aseptate or 1-septate, 20–30 \times 3–5 μ m; secondary branches aseptate, 15–25 \times 3–5 μ m, tertiary branches aseptate, 12–17 \times 3–5 μ m, additional branches (–), aseptate, 10–15 \times 3–5 μ m, each terminal branch producing 2–6 phialides; phialides doliform to reniform, hyaline, aseptate, 7–15 \times 3–4 μ m; apex with minute periclinal thickening and inconspicuous collarette. **Conidia** cylindrical, rounded at both ends, straight, (45–)48–55(–65) \times (4–)4.5(–5) μ m (av. = 51 \times 4.5 μ m), 1(–3)-septate, lacking a visible abscission scar, held in parallel cylindrical clusters by colourless slime. **Megaconidia** and **microconidia** unknown.

Specimens examined: **Ecuador**, soil, 20 Jun. 1997, M.J. Wingfield, **holotype** CBS H-17871, culture ex-type CBS 111406 = CPC 1635; CBS 111394 = CPC 1628; CBS 111412 = CPC 1648; CBS 111393 = CPC 1627; CBS 111425 = CPC 1657. **Brazil**, Belém, Cpatu, soil, 1996, P.W. Crous, CBS 111383 = CPC 1587.

Cultural characteristics: Colonies sienna on the surface, and umber in reverse; chlamydospores extensive, dense, occurring throughout the medium, forming microsclerotia, with moderate to extensive sporulation on the aerial mycelium.

Substrate: Soil.

Distribution: ?Brazil, Ecuador.

Notes: When first isolated, isolates of *Cy. ecuadoriae* were observed to also form a few conidia that were 3-septate when studied on CLA. Presently, however, strains seem to have lost this ability and only form 1-septate conidia. The same phenomenon was also observed in the strain obtained from Brazil (CBS 111383). Although the Brazilian strain clusters close to those obtained from Ecuador, its conidia are somewhat shorter (av. 44 μ m) than those from Ecuador (av. 51 μ m), and it might very well end up representing a cryptic species closely related to *Cy. ecuadoriae*.

Cylindrocladium ecuadoriae is morphologically similar to others in the *Cy. gracile* (Bugn.) Boesew. species complex. Its conidia are (45–)48–55(–65) \times (4–)4.5(–5) μ m (av. = 51 \times 4.5 μ m), thus longer and wider than those of *Cy. graciloideum* Crous & G.R.A. Mchau [(35–)40–48(–60) \times 4–5(–6) μ m (av. = 45 \times 4.5 μ m)], narrower than those of *Cy. gracile* [(38–)40–55(–65) \times (3.5–)4–5(–6) μ m (av. = 53 \times 4.5 μ m)], and shorter than those of *Cy. flexuosum* Crous [(44–)50–70(–80) \times

(4–)5–6 μm (av. = 65 \times 5 μm]). In the past, isolates of *Cy. ecuadoriae* were treated as representative of *Cy. pseudogracile* Crous, which has conidia of similar dimensions of [(40–)53–58(–65) \times (3.5–)4–5 μm (av. = 56 \times 4.5 μm)] and are 1(–3)-septate. *Cylindrocladium ecuadoriae* can be distinguished from *Cy. pseudogracile* based on its lower average conidial length, and the absence of a *Calonectria* state in culture (Crous 2002).

DISCUSSION

Several studies in recent years have focused on resolving the taxonomy of *Cylindrocladium* spp. with clavate vesicles (Crous *et al.* 1995, 1997, 1999, 2000, Kang *et al.* 2001, Crous 2002). In a study focusing on taxa with sphaeropedunculate vesicles, Crous *et al.* (2004) described nine new species from the *Cy. floridanum* species complex. Contrary to what we

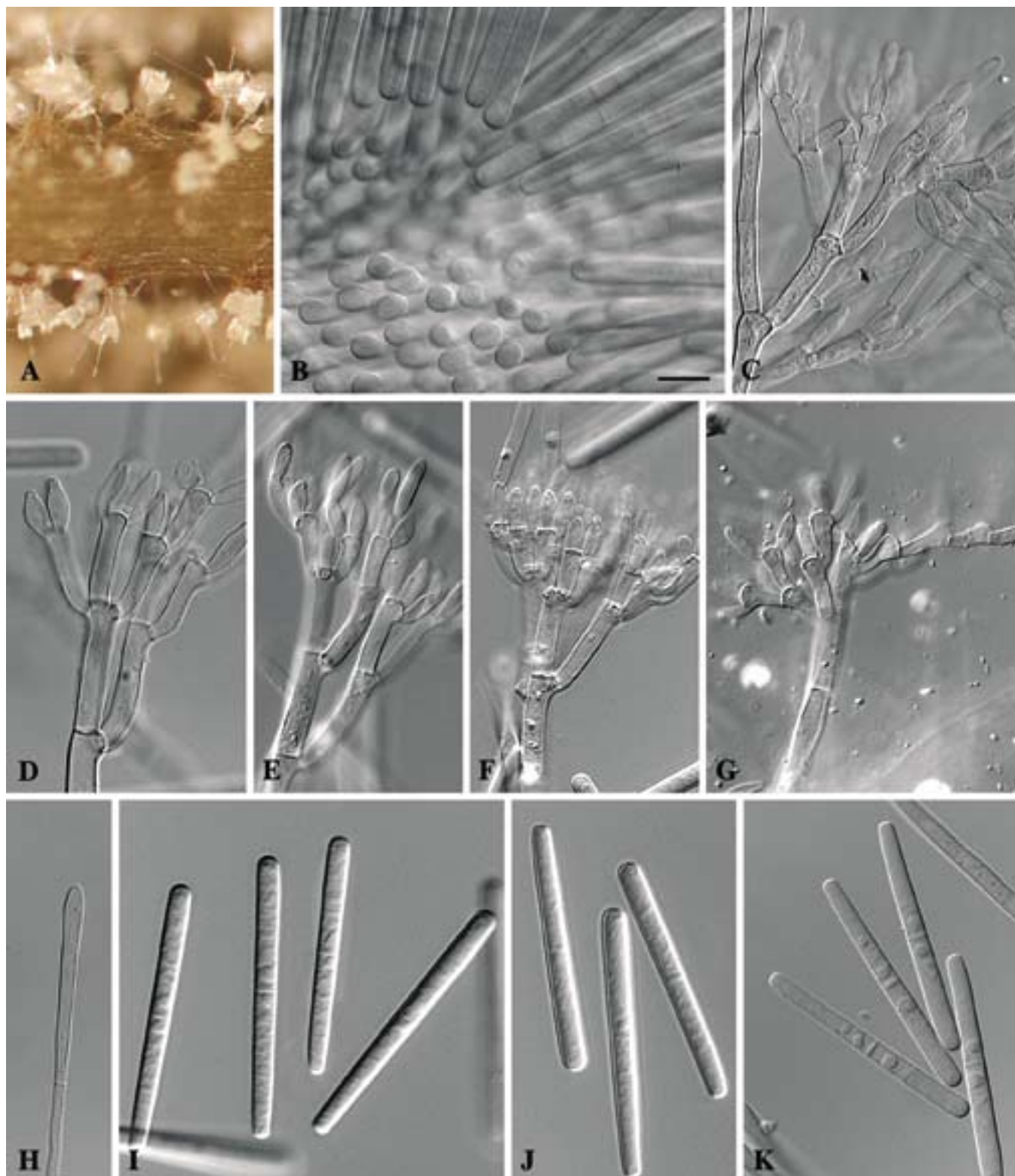

Fig. 5. *Cylindrocladium ecuadoriae*. A. Sporulation on CLA. B. Conidial packet. C–G. Conidiophores. H. Clavate vesicle. I–K. One-septate conidia. Scale bar = 10 μm .

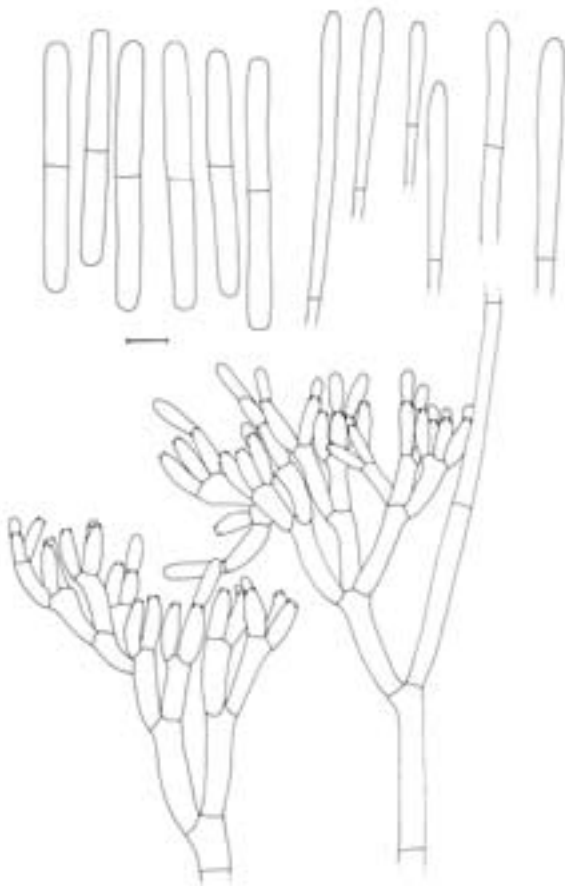

Fig. 6. *Cyindrocladium ecuadoriae*. Penicillate conidiophores, clavate vesicles and conidia. Scale bar = 10 μ m.

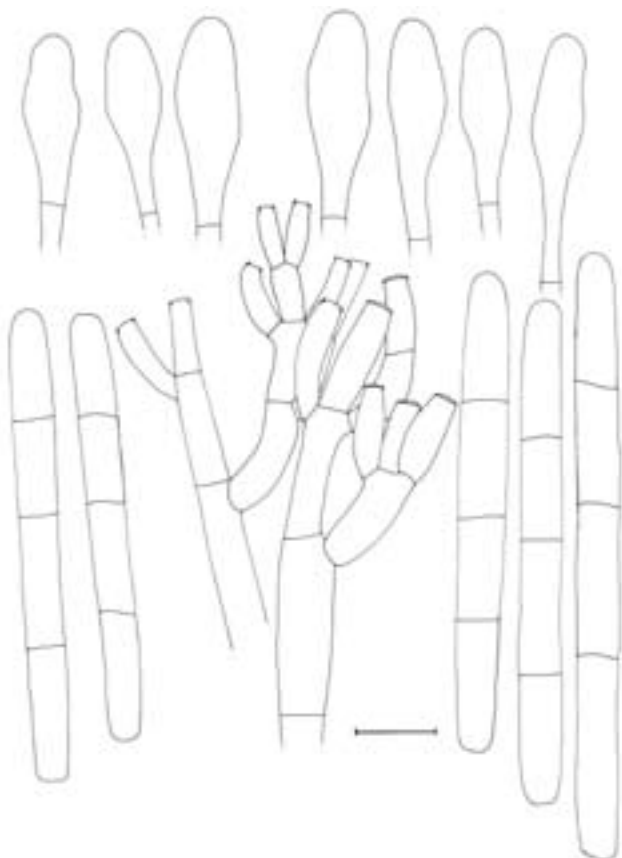

Fig. 7. *Cyindrocladium illicicola* (epitype). Conidiophore, vesicles and conidia. Scale bar = 10 μ m.

expected, only two new species could be resolved from all *Cyindrocladium* strains with clavate vesicles available to us. Part of the reason for this could be that this complex has been studied in more detail than that with sphaeropedunculate vesicles, but also that *Calonectria* teleomorphs are more common among species with sphaeropedunculate vesicles than those with clavate vesicles, causing more variation. Some taxa, for instance *Cy. colhounii* and *Cy. reteaudii*, proved to be quite variable for the loci sequenced. However, we believe that it is currently premature to split these species into more taxa, and that additional isolates and more loci will have to be investigated to fully resolve their status.

A further aim of the current study was to resolve the *Cy. pteridis* F.A. Wolf or *Cy. gracile*-like isolates associated with toppling disease of banana (Risède & Simoneau 2001, 2004). Although we originally expected these strains to represent an undescribed species, we were surprised to find that both β -tubulin and histone H3 datasets placed them in *Cy. flexuosum* (teleomorph *Ca. clavata*). This was rather unexpected, as conidia of *Cy. flexuosum* are [(44–)50–70(–80) \times (4–)5–6 μ m (av. 65 \times 5 μ m)] (Crous 2002), while those of the banana isolates are [(55–)68–75(–95) \times (5–)6–7 μ m (av. 70 \times 6 μ m)]. Notwithstanding this discrepancy, these isolates clustered together in a clade (100 % support) in both data sets, suggesting that the original ex-type strains, which have narrower, slightly curved conidia, might be atypical for what is commonly seen in this species. Although several attempts have been made over the years to redo the crosses between the two mating testers of *Cy. flexuosum*, or to mate them with the newly collected isolates from banana, none of the matings proved successful. These findings suggest, however, that the *Cy. gracile*-like isolates associated with toppling disease of banana should be attributed to *Cy. flexuosum*, and that the latter species is morphologically more variable than originally expected (Crous *et al.* 1995).

The description of *Cy. australiense* from Australia adds yet another species to the *Cy. colhounii*/*madagascariense*/*theae* complex. It appears, however, that there are yet more Australian species awaiting description, as CBS 112957, isolated from *Eleaocarpus angustifolius* in Queensland (Table 1), also clustered apart from any known taxon. Vesicles were clavate, and conidia 3-septate, 60–90 \times 5–6 μ m. We chose not to name this species, as the strain sporulated rather poorly, making it difficult to determine its range of morphological variation on CLA.

Isolates of *Cyindrocladium ecuadoriae* have until recently been treated under the name *Cy. pseudogracile*. Given the significant overlap in general conidial dimensions, this is not surprising, as these two species are rather similar, and can only be distinguished once the mean conidial dimensions have been determined. The single Brazilian isolate, CBS 11383, which again has smaller conidia than both *Cy. ecuadoriae* and *Cy. pseudogracile*, suggests that there may be yet more cryptic taxa within this complex that need to be resolved.

APPENDIX

Calonectria pyrochroa (Desm.) Sacc., *Michelia* 1: 308. 1878.

- ≡ *Nectria pyrochroa* Desm., *Pl. Crypt. France* Ed. 2: 372. 1856.
- = *Calonectria daldiniana* De Not., *Comment. Soc. Crittogam. Ital.* 2: 477. 1867.
- = *Ophionectria puiggarii* Speg., *Bol. Acad. Nac. Ci.* 11: 532. 1889.
- = *Nectria abnormis* Henn., *Hedwigia* 36: 219. 1897.

Anamorph: *Cylindrocladium illicicola* (Hawley) Boedijn & Reitsma, *Reinwardtia* 1: 57. 1950. Fig. 7.

- ≡ *Candelospora illicicola* Hawley, *Proc. Roy. Irish Acad.* 31: 11. 1912.
- = *Tetracytium lauri* Vanderw., *Parasitica* 1: 145. 1945. (as "laurii").

Macroconidiophores consisting of a stipe, a penicillate arrangement of fertile branches, a stipe extension, and a terminal vesicle; stipe septate, hyaline, smooth, up to 70 µm long, 5–6 µm wide; stipe extensions septate, straight to flexuous, 160–210 µm long, 3–4 µm wide at apical septum, terminating in an obpyriform to broadly ellipsoidal vesicle, 5–8 µm diam. *Conidiogenous apparatus* with primary branches that are aseptate or 1-septate, 15–20 × 3–5 µm; secondary branches aseptate, 10–20 × 3–5 µm, tertiary branches aseptate, rarely observed, 8–15 × 3–5 µm, each terminal branch producing 2–4 phialides; phialides doliform to reniform, hyaline, aseptate, 9–15 × 3–4 µm, apex with minute periclinal thickening and inconspicuous collarette. *Conidia* cylindrical, rounded at both ends, straight, (50–)63–68(–70) × 5(–6) µm, (1–)3-septate, lacking a visible abscission scar, held in parallel cylindrical clusters by colourless slime. *Megaconidia* and *microconidia* unknown.

Specimens examined: Ireland, Clare Island, *Ilex aquifolium*, Hawley, K 61269!, **holotype** of *Cy. illicicola*, IMI 76542 **isotype**. **Netherlands**, South-East Limburg, Vijlenerbos, Vijlen, *Ilex aquifolium*, Aug. 1970, H.A. van der Aa, **epitype designated here** CBS H-15110, ex-epitype culture CBS 749.70.

Cultural characteristics: Cultures sterile, white.

Substrate and distribution: See Crous (2002).

Notes: The genus *Calonectria* is based upon *Calonectria pyrochroa* (= *Ca. daldiniana*), which is linked to a *Cylindrocladium illicicola* anamorph (Rossman 1979, Brayford & Chapman 1987, Crous 2002). All cultures thus far collected by us, and thought to be representative of *Cy. illicicola*, have turned out to represent other species, and hence no authentic cultures of *Cy. illicicola* have as yet been obtained. A strain not previously studied by us was recently retrieved from the CBS collection (CBS 749.70). Although the isolate sporulated poorly, it was accompanied by a very good specimen, which proved to be identical to the original holotype collection. We therefore designate this specimen as epitype, thereby obtaining an authentic strain of *Cy. illicicola* for further study.

Curviciadiella Decock & Crous, **nom. nov.** MycoBank MB500866.

- ≡ *Curviciadium* Decock & Crous, *Mycologia* 90: 276. 1998 [non *Curviciadium* Enroth, 1993].

Type species: Curviciadiella cigneae (Decock & Crous) Decock & Crous

Curviciadiella cigneae (Decock & Crous) Decock & Crous, **comb. nov.** MycoBank MB500867.

- ≡ *Curviciadium cigneum* Decock & Crous, *Mycologia* 90: 277. 1998.

Specimens examined: French Guiana, Matoury, first part of the Lamirande trail, on decaying leaf of unknown angiosperm, 23 Jan. 1997, C. Decock FG2240, MUCL 40269 = CPC 1595 = CBS 109167 (ex-type culture); on decaying seed of unknown angiosperm, 20 Jan. 1997, C. Decock FG2158, MUCL 40268 = CPC 1594 = CBS 109168.

Notes: It was recently brought to our attention (J. Bischoff, NCBI), that the generic name "*Curviciadium*", which was proposed by Decock & Crous (1998) for a anamorphic fungus collected from leaf litter in French Guiana, was already occupied for a species of moss (Enroth 1993). A new name is thus called for, and herewith we propose *Curviciadiella* Decock & Crous, to replace *Curviciadium* Decock & Crous (1998).

ACKNOWLEDGEMENTS

The authors acknowledge collections made by various researchers, without which this study would not have been possible. We are especially grateful to C. Pearce, B. Paulus, H.A. van der Aa, A.C. Alfenas and M.J. Wingfield, who placed numerous collections from diverse locations at our disposal for study. Bart van Asten (CBS) is thanked for the sequencing of isolates.

REFERENCES

- Brayford D, Chapman AU (1987). *Cylindrocladium illicicola* on cuttings of evergreen ornamental shrubs in the U.K. *Plant Pathology* 36: 413–414.
- Crous PW (2002). *Taxonomy and pathology of Cylindrocladium (Calonectria) and allied genera*. APS Press, St. Paul, MN, U.S.A.
- Crous PW, Groenewald JZ, Risède J-M, Simoneau P, Hywel-Jones NL (2004). *Calonectria* species and their *Cylindrocladium* anamorphs: species with sphaeropedunculate vesicles. *Studies in Mycology* 50: 415–430.
- Crous PW, Kang JC, Schoch CL, Mchau GRA (1999). Phylogenetic relationships of *Cylindrocladium pseudogratile* and *Cylindrocladium rumohrae* with morphologically similar taxa, based on morphology and DNA sequences of internal transcribed spacers and β-tubulin. *Canadian Journal of Botany* 77: 1813–1820.
- Crous PW, Korf A, Van Zyl WH (1995). Nuclear DNA polymorphisms of *Cylindrocladium* species with 1-septate conidia and clavate vesicles. *Systematic and Applied Microbiology* 18: 224–250.
- Crous PW, Theron L, Van Zyl WH (1997). Delineation of *Cylindrocladium* species with 1–3-septate conidia and clavate vesicles based on morphology and rDNA RFLPs. *Mycological Research* 101: 210–214.
- Crous PW, Schoch CL, El-Gholl N, Schubert TS, Leahy RM (2000). *Cylindrocladium angustatum* sp. nov., a new leaf spot pathogen of *Tillandsia capitata* from Florida, U.S.A. *Mycoscience* 41: 521–526.
- Crous PW, Wingfield MJ (1992). *Cylindrocladium leucothoes* and *C. hederiae*, synonyms of *C. reteaudii*. *South African Journal of Botany* 58: 397–400.
- Decock C, Crous PW (1998). *Curviciadium* gen. nov., a new hyphomycete genus from French Guiana. *Mycologia* 90: 276–281.
- Enroth J (1993). Notes on the *Neckeraceae* (Musci). 18. Description of *Curviciadium*, a new genus from Southern and Southeastern Asia. *Annales Botanici Fennici* 30: 109–117.

- Gams W, Hoekstra ES, Aptroot A (eds) (1998). *CBS Course of Mycology*. 4th ed. CBS, Baarn, Netherlands.
- Kang JC, Crous PW, Old KM, Dudzinski MJ (2001). Non-conspicuity of *Cylindrocladium quinqueseptatum* and *Calonectria quinqueseptata* based on beta-tubulin gene phylogeny and morphology. *Canadian Journal of Botany* **79**: 1241–1247.
- Lee SB, Taylor JW (1990). Isolation of DNA from fungal mycelia and single spores. In: *PCR Protocols: A guide to methods and applications* (Innis MA, Gelfand DH, Sninsky JJ, White TJ, eds). Academic Press, San Diego, California: 282–287.
- O'Donnell K, Cigelnik E (1997). Two divergent intragenomic rDNA ITS2 types within a monophyletic lineage of the fungus *Fusarium* are nonorthologous. *Molecular Phylogenetics and Evolution* **7**: 103–116.
- Rambaut A (2002). Sequence Alignment Editor. Version 2.0. Department of Zoology, University of Oxford, Oxford.
- Rayner RW (1970). *A mycological colour chart*. CMI and British Mycological Society. Kew, Surrey, England.
- Risède J-M, Simoneau P (2001). Typing *Cylindrocladium* species by analysis of ribosomal DNA spacers polymorphism: application to field isolates from the banana rhizosphere. *Mycologia* **93**: 494–504.
- Risède J-M, Simoneau P (2004). Pathogenic and genetic diversity of soilborne isolates of *Cylindrocladium* from banana cropping systems. *European Journal of Plant Pathology* **110**: 139–154.
- Rossmann AY (1979). *Calonectria* and its type species, *C. daldiniana*, a later synonym of *C. pyrochroa*. *Mycotaxon* **8**: 321–328.
- Swofford DL (2002). *PAUP*. Phylogenetic Analysis Using Parsimony (*and other methods)*. Version 4. Sinauer Associates, Sunderland, MA, U.S.A.