

UNDERSTANDING THE INFLUENCE OF ICT ON PEDAGOGICAL  
PRACTICES IN THE TEACHING OF ELECTRONICS COURSES IN NIGERIAN  
TVET INSTITUTIONS

BASHIR ABUBAKAR

UNIVERSITI TUN HUSSEIN ONN MALAYSIA

UNDERSTANDING THE INFLUENCE OF ICT ON PEDAGOGICAL  
PRACTICES IN THE TEACHING OF ELECTRONICS COURSES IN NIGERIAN  
TVET INSTITUTIONS

A thesis submitted in partial fulfilment of the requirement for the award of the degree  
of Master in Technical and Vocational Education

Faculty of Technical and Vocational Education  
Universiti Tun Hussein Onn Malaysia

FEBRUARY, 2016

## DEDICATION

*Bismillahirrahmanirrahim.....*

First and foremost, I would like to dedicate this research to almighty Allah, for the strength and knowledge he gave me to do this research.

This thesis is also dedicated with deepest gratitude to all my family members, for instilling in me the determination and strength to believe in my dreams, and for making the dream a reality.

I also like to dedicate this research to my able and humble supervisor Assoc. Prof. Dr. Mohamad Hisyam Mohd Hashim, who gave me his full support and guidance in making this research.

Last but not the least, I dedicate this research to Federal College of Education (Tech) Potiskum, Yobe State Nigeria for their sponsorship and encouragements. I sincerely offer this thesis to serve as a legacy to leave for the college.

## ACKNOWLEDGEMENTS

In the name of Allah, the beneficent, the most merciful, all praises be to Allah the Lord of the world, who gave me the courage and patience to accomplish this work. May peace and blessings of Allah be upon his servant and messenger Muhammad (S. A.W), his family and his companions. This research work has been carried out on a full-time basis starting February 2013, and would not have been possible without support and cooperation from various personalities. Firstly, I am grateful to Federal College of Education (Tech) Potiskum, Yobe state Nigeria for sponsoring my master programme at Universiti Tun Hussein Onn Malaysia through TETFund. Particular recognition goes all academic staff in electrical/electronic department of Federal College of Education (Tech) Potiskum who has spared their valuable time in taking over my teaching loads while undergoing my study in Malaysia. I would like to appreciate and thank my supervisor Assoc. Prof. Dr. Mohamad Hisyam Mohd Hashim for his support and valuable contribution.

Special thanks to my father and mother for their prayers, encouragement, and support. I would also like to thank my brothers, and sisters for their unconditional love and prayers. Special thank goes to my causing brothers Bashir Abubakar Sadiq for his support and encouragement. My warmest thank to UTHM for conducive research environment and also ORIC for their financial support. I wish to express my sincere thanks and appreciation to FPTV management especially to the Dean Assoc. Prof. Dr. Razali Bin Hassan, Deputy Dean, in persons of Dr. Badaruddin Bin Hassan and staff especially Dr. Nursoffura, Dr. D'oria Islamiah Binti Rosli for their guidance and positive contributions. Thanks to all of my friends who pray and provide any kind of support in seeing to the success of my programme. A special thanks to my wife Aisha Adamu for her patience, constant encouragement, love, sacrifice and special prayers, and my kid's Sadiya, Mariya and Yahaya for their love and patience.

## ABSTRACT

As information and communication technologies get its way into the educational environment, it may be difficult for the teaching and learning activities especially in TVET institutions to remain unchallenged. However, it is evident from the Literature that ICT application as a pedagogical tool in the Nigerian TVET institutions is not a common practice, it also remain unclear how utilization of ICTs enhances teachers pedagogy. Therefore, this study is interested in what effect these ICTs have on teacher's pedagogy practices especially in the teaching of electronic courses. Using activity theory as a guide, multiple case study was conducted. Five TVET institutions and twenty participants were selected using maximum variation and homogeneous purposive sampling strategies respectively. During the institutions visit, classroom observation was carried out, documents such as a curriculum and teachers lecture materials were reviewed for triangulation purpose. Semi-structured interview was conducted with 20 selected participants as primary data collection method. At data analysis stage, Inductive and deductive methods were used to analyze the data, two strategies of grounded theory as open and axial coding were employed. The coding process was achieved through the use of an inherent feature of NVivo10. Despite numerous positive influence of ICTs on teacher's pedagogical practices, the cross-cases highlighted that ICTs have adverse impact on student ethics. ICTs enable teachers to have greater control over their lesson preparation and delivery, through the use of simulation softwares, teachers try to make abstract concept more concrete to students understanding. It is also evident from the findings that there have been challenges inhibiting the successful use of ICTs as a pedagogical tool in the teaching of electronic courses. These challenges include lack of institutional ICT policy and curricular that focuses on ICTs usage as an educational tool among others. Finally, the study suggested consistent researches to be conducted in this area so that stakeholders would be fully aware of new development and challenges toward the use of ICT as pedagogical tool in the teaching of electronic courses.

## ABSTRAK

Bidang Teknologi Komunikasi dan Maklumat (TMK) kian mendapat tempat dalam dunia pendidikan dan menjadi cabaran kepada aktiviti pengajaran dan pembelajaran terutamanya di institusi pendidikan teknik dan vokasional. Kajian literatur menunjukkan aplikasi TMK sebagai alat pedagogi dalam TVET di Nigeria bukanlah suatu amalan yang biasa dipraktikkan di mana keberkesanan penggunaan TMK dalam meningkatkan pedagogi guru juga belum dapat dilihat. Justeru, kajian ini bertujuan untuk melihat kesan penggunaan TMK terhadap amalan pedagogi para guru terutamanya dalam pengajaran bidang elektronik. Menggunakan Teori Aktiviti sebagai panduan, kajian kes berganda melibatkan lima institusi TVET dan dua puluh orang peserta telah dijalankan. Pemilihan sampel adalah berdasarkan variasi maksimum dan pemantauan dokumen seperti kurikulum dan bahan pengajaran dilakukan bagi tujuan triangulasi data. Temu bual separa berstruktur melibatkan dua puluh peserta juga dijalankan sebagai kaedah pengumpulan data utama. Untuk menganalisa data, kaedah induktif dan deduktif serta dua strategi teori mendalam iaitu pengekodan terbuka dan pengekodan paksi digunakan. Proses pengekodan dicapai melalui penggunaan perisian NVivo10. Walaupun dapatan mendapati penggunaan TMK memberikan kesan positif terhadap amalan pedagogi para guru, paparan silang kes menunjukkan TMK memberikan kesan terhadap etika pelajar. TMK membolehkan guru mempunyai kawalan yang luas terhadap penyediaan bahan serta proses penyampaian pengajaran. Penggunaan perisian simulasi dapat menjadikan konsep abstrak kepada lebih konkrit dan ini membantu memudahkan kefahaman pelajar. Hasil dapatan juga menunjukkan terdapat beberapa cabaran yang menghalang kejayaan penggunaan TMK sebagai alat pedagogi di institusi TVET di Nigeria. Antara cabaran tersebut adalah kemudahan TMK yang tidak mencukupi, tiadanya polisi TMK di institusi serta kurangnya kurikulum yang memberi tumpuan kepada penggunaan TMK dalam pengajaran. Akhir sekali, kajian ini mencadangkan kajian yang lebih konsisten perlu dilaksanakan supaya pihak yang berkepentingan sedar tentang pembangunan dan cabaran terhadap penggunaan TMK sebagai alat pedagogi terutamanya dalam pengajaran kursus- kursus elektronik.

## TABLE OF CONTENTS

<b>STATUS CONFIRMATION</b>	
<b>EXAMINERS' DECLARATION</b>	
<b>TITLE</b>	<b>i</b>
<b>DECLARATION</b>	<b>ii</b>
<b>DEDICATION</b>	<b>iii</b>
<b>ACKNOWLEDGEMENT</b>	<b>iv</b>
<b>ABSTRACT</b>	<b>v</b>
<b>ABSTRAK</b>	<b>vi</b>
<b>TABLE OF CONTENT</b>	<b>vii</b>
<b>LIST OF TABLES</b>	<b>xii</b>
<b>LIST OF FIGURES</b>	<b>xiii</b>
<b>LIST OF ABBREVIATIONS</b>	<b>xiv</b>
<b>CHAPTER1: INTRODUCTION</b>	
1.1 Introduction	1
1.2 Background of the problem	2
1.3 Problem Statement	4
1.4 Scope of the Study	5
1.5 Definition of Terms	5
1.5.1 Information and Communication Technologies (ICTs)	5
1.5.2 Teacher	5
1.5.3 Pedagogy	6
1.6 Theoretical framework	6
1.7 Purpose of the Study	7
1.8 Main Research Question	7
1.8.1 Sub-Question	7
1.9 Significance of the Study	7
1.10 Overview of Research Design	8
1.11 Structure of the Thesis	11
<b>CHAPTER 2: LITRATURE REVIEW</b>	<b>12</b>
2.1 Introduction	12

2.2	ICT and Education	13
2.4	Understanding Pedagogy	14
2.4.1	Pedagogy and the use of ICT	14
2.4.2	Pedagogy in the Teaching of Electronics	16
2.5	ICTs in the Teaching of Electronics	16
2.5.1	Multisim Simulation Software	17
2.5.2	Electronic Logic Gates	21
2.5.3	Quartus II Software	22
2.6	Influences of ICTs on Teachers Practice and Students Learning	24
2.7	Nigeria's Vision for Integrating ICT in Schools	25
2.7.1	Nigerian TVET Institutions	28
2.7.2	Impact of ICT Integration in Nigerian TVET Institutions	30
2.7.3	Challenges faced toward ICT Integration in Nigerian Institutions	32
2.8	Activity Theory and its Development	33
2.8.1	Activity System	34
2.9	Theoretical Framework Guiding this Study	38
	<b>CHAPTER 3: METHODOLOGY</b>	<b>40</b>
3.1	Introduction	40
3.2	Research Design and Methods	40
3.3	Qualitative Multiple Case Study Design	42
3.3.1	Selection of Cases to be Studied	42
3.3.2	Selection of Participants	43
3.3.3	Institution Visits	45
3.4	Method of data Collection and Process	46
3.4.1	Semi-structured Interview	46
3.4.2	Observation	48
3.4.3	Document Analysis	49
3.5	Criteria for Trustworthiness in this Study	49
3.6	Data Analysis	51
3.6.1	Data Reduction	51
3.6.2	Categorization of Data	52
3.6.3	Axial coding	52



3.7 Ethics	53
<b>CHAPTER 4: FINDINGS</b>	<b>54</b>
4.1 Introduction	54
4.2 Within Case Analysis	54
4.2.1 Emerging findings	55
4.3 TVET Institution 1	55
4.3.1 Background of TVET Institution 1	55
4.3.2 Participant in TVET Institution 1	56
4.3.3 ICT Infrastructures in TVET Institution 1	56
4.3.4 ICT Access in TVET Institution 1	61
4.3.5 ICT Utilization as a pedagogical Tool in TVET institution1	63
4.3.6 ICT influence on pedagogical practice in TVET Institution1	67
4.4 TVET Institution 2	71
4.4.1 Background of TVET Institution 2	71
4.4.2 Participant in TVET institution 2	71
4.4.3 ICT Infrastructures in TVET Institution 2	72
4.4.4 ICT Access in TVET institution 2	76
4.4.5 ICT Utilization as a Pedagogical Tool in TVET Institution2	79
4.4.6 ICT Influence on Pedagogical Practice in TVET Institution2	81
4.5 TVET Institution 3	85
4.5.1 Background of TVET Institution 3	86
4.5.2 Participant in TVET Institution 3	86
4.5.3 ICT Infrastructures in TVET institution 3	87
4.5.4 ICT Access to in TVET institution 3	88
4.5.5 ICT Utilization as a Pedagogical Tool in TVET Institution3	91
4.5.6 ICT Influence on Pedagogical practice in TVET Institution3	94
4.6 TVET Institution 4	97
4.6.1 Background of TVET Institution 4	97
4.6.2 Participant in TVET Institution 4	98
4.6.3 ICT Infrastructures in TVET Institution 4	98
4.6.4 ICT Access in TVET institution 4	99
4.6.5 ICT Utilization as a Pedagogical Tool in TVET Institution 4	100

4.6.6 ICT Influence on pedagogical practice in TVET Institution 4	103
4.7 TVET Institution 5	105
4.7.1 Background of TVET Institution 5	106
4.7.2 Participant in TVET Institution 5	106
4.7.3 ICT Infrastructures in TVET Institution 5	107
4.7.4 ICT Access to in TVET institution 5	108
4.7.5 ICT Utilization as a Pedagogical Tool in TVET Institution 5	110
4.7.6 ICT Influence on Pedagogical practice in TVET Institution 5	112
4.8 Cross-case Analysis	114
4.8.1 ICT Infrastructures in Nigerian TVET Institutions	114
4.8.1.1 Availability of hardware	115
4.8.1.2 Location of Computer	116
4.8.1.3 Availability of educational software	117
4.8.1.4 Computers connected to the Internet and LAN Network	118
4.9 ICT infrastructure Access in Nigerian TVET Institution	119
4.9.1 Teachers access to ICT infrastructures	119
4.9.2 Students Access to ICT Infrastructure	121
4.9.3 Constrains Toward ICT Access in Nigerian TVET Institution	122
4.10 Utilization of ICTs as a Pedagogical Tool in Nigerian TVET Institution	123
4.10.1 Utilization of Software's in the Teaching of Electronic	123
4.10.2 Concept Taught Using ICT in Nigerian TVET Institutions	125
4.10.3 Challenges hindering the use of ICTs in Nigerian TVET Institutions	126
4.11 ICT Influence on Pedagogical Practices in Nigerian TVET Institutions	127
4.12 Summary of the Findings	129

<b>CHAPTER 5: DISCUSSION, CONCLUSION AND SUGGESTION</b>	<b>131</b>
5.1 Introduction	131
5.2 Discussion	131
5.2.1 ICT Infrastructures in Nigerian TVET Institutions	131
5.2.1.1 Location of Computer	132
5.2.1.2 Computers connected to the LAN and the Internet	132
5.2.3 ICT Access to Teachers and Student in Nigerian TVET Institution	133
5.2.4 ICT Utilization as pedagogical tool in Nigerian TVET Institution	133
5.2.5 ICT influence on pedagogical practices in Nigerian TVET Institution	135
5.3 Conclusions	137
5.3.1 Introduction	137
5.3.2 Summary of the Findings	138
5.3.2.1 Adequacy of ICT Infrastructures in Nigerian TVET Institution.	138
5.3.2.2 Accessibility of ICT Infrastructure in Nigerian TVET Institution among Teachers and Students	139
5.3.2.3 Extent of ICT Utilization as Pedagogical Tool in Nigerian TVET Institution.	139
5.3.2.4 Influences of ICTs on Pedagogical Practices in the Teaching of Electronics courses.	140
5.4 Contribution of the Research	142
5.5 Limitations of the Research	143
5.6 Suggestion for Further Research	144
<b>REFERENCES</b>	<b>145</b>
<b>APPENDICES</b>	<b>158</b>

**LIST OF TABLES**

4.1	Number of Computers per Institution	116
4.2	Computer Location	118
4.3	Computers connected to the LAN and the Internet	119
4.4	Teachers access to computers	121
4.5	Students access to computers	122
4.6	Factor Constraining ICT Access in Electronic Departments	123
4.7	Electrical and Electronic Teachers use of ICT	125
4.8	Concept taught and ICT facilities being used	126
4.9	Challenges Militating against the Successful use of ICTs	127
4.10	ICT Influences on pedagogical Practices and Student Learning	129

## TABLE OF FIGURES

1.1	Research framework of the study	9
2.1	Multisim Software install on a common window	18
2.2	The basic concept of current commutation in rectifiers	19
2.3	Basic concept of current commutation in rectifiers Graph for Current and Voltage	19
2.4	Line Frequency Diode Rectification Circuit	20
2.5	Combinational Logic Gates Switching a Segment	22
2.6	Compiled Schematic Design	23
2.7	Functional Simulation Result	23
2.6	First generation activity theory	35
2.7	Engestrom’s Expended Activity Theory	35
2.8	Interacting activity systems arranged in concentric circles	37
2.7	Activity Theoretical framework guiding the Study	38
3.1	Research design of the study	42
5.1	ICT influences on teachers pedagogical activity and student learning	142
5.2	Pedagogical activity System	143

## LIST OF ABBRIVIATIONS

ICTs	Information and Communication Technologies
UNESCO	United Nations Scientific Educational and Cultural Organization
MDGs	Millennium Development Goals
EFA	Education for All
IWS	Internet World Stats
NITDA	National Information Technology Developments Agency
BECTA	British Educational Communications and Technology Agency
FRN	Federal Republic of Nigeria
FME	Federal Ministry of Education
NBTE	National Board for Technical Education
NCCE	National Commission for Colleges of Education
MOE	Ministry of Education
FSD	Flexible Skills Development
ADEA	Association for the Development of Education in Africa
P21,	Partnership for the 21 <sup>st</sup> Century
NPE	National policy on Education
NGOs	Non-governmental Organization
NEPAD	New partnership for African Development
ETF	Education Tax Fund

## **CHAPTER 1**

### **INTRODUCTION**

#### **1.1 Introduction**

The governments of various nations, non-governmental organizations and academic institutions around the world have made significant investments in computer-based information technology to support teaching and learning process (Webb, 2007). Such investments made is toward enhancing the quality of education and learning that in turn gives the student a better chance to participate in the 21<sup>st</sup> Century learning environment. Information and communication technologies (ICTs) are valuable tools for achieving excellence in the teaching and learning process (Intel Corporation, 2007). ICTs include computers, LCD projectors software's and the Internet among others. Osakwe (2010), believed that such facilities were the most significant tools in the teaching and student learning.

This study intends to examine and understands how teacher's utilization of ICTs influences their pedagogical practices within the four walls of the classroom. This research focuses on the teaching and learning of electronic courses to make the study manageable and convenient. Pedagogical practices signify numerous strategies used in different combinations for improving student learning outcome. According to Jaji (2008), no particular approach is appropriate for all teaching situations. The term influence of ICTs in this research work refers to the effect of technology on pedagogy to enhance teachers' practices, as well as the student learning process. Teachers' role is of paramount important because they are the ones who handle the extraction of lesson objectives from the syllabus at their disposal (Farhat, 2008).

It is the teacher who decides on the software appropriate to be used to achieve the lesson objectives, teachers need technological skills and commitment towards ensuring effective teaching and learning using ICTs in educational institutions (Almadhour, 2010). Thus, it is essential for teachers to understand issues revolving around ICTs and its effect on their pedagogical activities so that they will be able to utilize ICTs as a pedagogical tool. Hence, the need to explore and understand in details how ICTs influences teacher's pedagogy in the teaching of electronic courses.

## **1.2 Background of the problem**

The world event in the 21<sup>st</sup> century has turned to information and communication technologies, the world will continue to move further whether nations across the world embrace its use or not (Ajisebutu, 2010). In this regard, quite a good number of developed and developing countries around the globe believe that ICTs will continue to be a critical facilitator of effective teaching and student learning (Jaji, 2008). As such, the established academic institutions struggle to keep up with the new changes (Webb, 2007). Indeed, such conflict is increasing burden on all institutions around the world. Therefore, with this recent development, it is necessary for teachers to change their pedagogical practices to realize the potential of ICTs (Webb, 2007).

In this vein, Ololube, Ubogu, & Egbezo (2007), pointed out that teachers need to learn how to integrate ICTs effectively into their classroom activities. It was evident that African countries like Nigeria, Namibia, and Tanzania among others have been making a considerable effort toward transforming their schools with the use of ICTs as a pedagogical tool. The effort made by such African countries were through the leadership of SchoolNet. In the year 2000, over 300 schools witnessed the provision of innovative computer technologies and the Internet in Namibia which was through SchoolNet (Farrell, Isaacs, Trucano, Hamdy, Hare, Tetang Tchinda, & Fall, 2007). Similarly, under E.T.F sponsorship, SchoolNet Nigeria was launched in September 2001. SchoolNet Nigeria continues to deploy ICTs to be used in teaching and learning (Adomi, 2005).

Nigerian government has developed specific ICT-related policies with lofty goals in 2001, the formulated policies focus on the country education system that includes TVET institutions so that they could effectively utilize ICTs (Oyenike,



2010). Technical and vocational institutions are the ones responsible for producing technologist and technicians in several disciplines (Goro, 2012); such training includes electrical and electronics as a course of study. Indeed, utilization of ICTs as Pedagogical Tool in such TVET institutions facilitates appropriate practice, provide new instructional stimuli, and sequence learning appropriately among others (Osakwe, 2010). ICT skills in TVET institutions are necessary especially to such systems that produce educators in technical education with pedagogical skills, technicians, and technologists (Ololube *et al.*, 2007). Nonetheless, Nigerian TVET system has been criticized for the institutions lagging behind in the use of ICTs as a pedagogical tool.

Furthermore, the assertion is supported by the first-ever TVET Summit organized by UNESCO-UNEVOC, which was held before a second international conference held in Nairobi (Hooker, Mwiyeria & Verma 2011). Among other reasons for the institutions to lag behind were a lack of knowledge and expertise in the use of these new technologies as pedagogical tools. Challenges faced by Nigerian TVET institutions include a lack of adequate ICT infrastructures that significantly reduced the level of ICT access to both trainers and trainees (Ololube *et al.*, 2007). Quite a good number of the teachers in Nigeria have been unable to find the effective ways to use technology in their classroom as a pedagogical tool.

Thus, it is correct to state that the significant effort by the federal government of Nigeria toward the successful use of ICT in Nigerian TVET institutions was in vein. Perhaps, it is evident that the acquisition of ICT knowledge, skills regarding its use as pedagogical tool remain the future ambition of many Nigerian TVET teachers. In this regard, it is important to provide Nigerian TVET teachers with information that will serve as additional support and awareness for improving their professional practices particularly in the field of electrical/electronic discipline. Such information will benefit not only teachers but also the school management and in turn, the community as well. In this vein, this research was initiated to focus on issues revolving around ICTs and its influence on the teachers' pedagogical practice in the teaching of electronics courses.

### 1.3 Problem Statement

Considering a tremendous effort by the federal government of Nigeria towards the successful use of ICTs in the teaching and learning, the government formulated several policies with lofty goals. Among other policy objectives were to encourage teachers to develop a sense of rapport with computer to solve teaching and learning challenges. Between the year 2007 and 2013, the federal government of Nigeria has tripled the allocation for education from N224 billion to N634 billion (Federal Ministry of Finance Budget, 2014). As a result, Federal government of Nigerian has achieved distribution and installation of computers in some schools, there are ICT centers in all the Nigerian Universities (Jegade, 2008). Considering the effort made by the federal government of Nigeria, it has the intention to sustain meaningful change to pedagogical practice in TVET institutions.

The implementation of ICTs in Nigerian TVET institutions, especially in the field of electrical/electronics is necessary if teachers and their student are to be part of the learning environment in the present century. According to Jaji (2008), ICTs have impacted on teaching and research in Nigerian schools. However, there has been a serious complaint that the development of ICT has not been accompanied by the same growth of ICT integration in the classroom (Jaji & Abubakar, 2012). Consequently, teachers cannot implement ICTs in education as a pedagogical tool because they are not competent in basic computer operation (Igbuzor, 2008). It is evident that there had been little application of ICTs in the TVET sub-sector in 52 African countries including Nigeria (Farrell, *et al.*, 2007).

It also remains unclear the types of ICT facilities available in Nigerian TVET institutions, how teachers access and utilizes the available facilities and how the use of ICTs enhanced their pedagogy. Thus, this signifies that the use of ICTs particularly in the teaching of electronic courses is minimal. However, the reasons for such little use are not well established through research. Therefore, as a result of the shortcomings in Nigerian education system, and also discrepancies in various research findings cast doubt on whether the existing TVET institutions in Nigeria utilize ICTs as a pedagogical tool. It is therefore in line to state that such important issues have not been given the deserve attention through research as there are limited studies in the area. In the same vein, it makes sense to state that the use of

ICT as a pedagogical tool in the Nigerian TVET institutions particularly in the field of electronics is not a common practice. Perhaps, this strongly suggests that current pedagogical practices using information and communication technology need an entire revision to understand the current learning style in Nigerian TVET institutions.

#### **1.4 Scope of the Study**

For the purpose of making this study more convenient and manageable, the research is confined mainly toward understanding numerous strategies used by the teachers in the teaching of electrical and electronic courses under the influence of ICTs. This study involves only teachers handling electrical/electronic courses. In this study, ICTs were restricted to computers, LCD projectors software's, and the Internet. Also, the study was narrowed to the Nigerian technical and vocational institutions located at Northeastern part of the country.

#### **1.5 Definition of Terms**

##### **1.5.1 Information and Communication Technologies (ICTs)**

Information and Communication Technologies includes any communication device or application such as network, hardware, software, radio, cellular phones, television, computer and, satellite systems (Oviawe & Oshio, 2011). However, in this study, ICTS are restricted to Computers, LCD projectors, simulation software's, MS Excel and the Internet. According to Tsebee & Akpobo (2015), the essential and the most influential ICTs facilities include computers, LCD projectors, software, and the internet. Thus, all such tool need to be fully utilized to engage the student.

##### **1.5.2 Teacher**

A teacher is a person whose role is often formal and ongoing, he acts as a pivot for the transmission of technical skills and intellectual traditions from one generation to

another and helps to retain the lamp of civilization burning. The teacher is the key to quality education (Khan, 2011). Therefore, in this research, a teacher is considered as a person responsible for facilitating student learning through the use of curriculum as a guide, and possesses professional qualifications that include the study of pedagogy, which is the science of teaching.

### **1.5.3 Pedagogy**

Pedagogy refers to any conscious activity designed by one person to bring about student learning. Pedagogy will be useful if it is transparent about its goals and capable of providing motivation, with high expectations that spring naturally from the belief and aspirations of the teacher and learner (Hardman, 2007).

## **1.6 Theoretical framework**

The activity-theoretical framework was used as a theoretical lens for this study as it can provide insights into the changes in pedagogical practices (Murphy & Rodriguez, 2008). According to Mlambo (2007), using activity theory as theoretical framework is one way to understand how ICT influences teaching and learning environment. Therefore, to explore and provide a descriptive and interpretive account on how ICTs influences pedagogical practices, activity theory was adopted. The fundamental principle of the activity theory is that ICTs does not exist in isolation but rather intertwined with the rest of the tools and the participant in the learning environment. The activity theory was used as a guide in this study to develop research questions, as well as a guide at the analysis stage. Thereby research questions and observation checklist were inseparably tied to the activity theoretical framework.

It is evident that activity theory was used by Lim in (2002) as a theoretical framework to investigate how ICT mediated teaching and learning process in Singapore schools. Similarly, Mlambo (2007) uses activity theory as a theoretical framework to study ICTs in A-level physics teaching in Manicaland Zimbabwe. Most recently, Robertson, (2008) have successfully examined the integration of technology into Turkish schools using activity theory. However, activity theory is

adapted to the context in Nigeria seeking to understand how ICTs influence or enhance teacher practices in the course of teaching electronic courses.

### **1.7 Purpose of the Study**

The primary aim of this study is to understand and gain insight into how information and communication technologies influences pedagogical practices in the teaching and learning of electronic courses.

### **1.8 Main Research Question**

How does the use of ICTs influence pedagogical practices in the teaching and learning of electronic courses in Nigerian TVET institutions?

#### **1.8.1 Sub-Question**

- 1) How adequate is the provision of ICT infrastructures for utilization as a pedagogical tool in Nigerian TVET institutions?
- 2) How do teachers and students have access to ICTs in Nigerian technical and vocational institutions?
- 3) How do teachers utilize ICTs as a pedagogical tool in the teaching and learning of electronic courses?
- 4) How does utilization of ICTs enhance pedagogical practices in the teaching of electronic courses?

### **1.9 Significance of the Study**

The acquisition of ICT knowledge and skills remain the future ambition of many Nigerian TVET teachers. Hence, there is a need to provide teachers with information that will serve as additional support and awareness for improving their professional practices. Specifically, the study is significant in the following areas.

- i) This study will create awareness to certain extent regarding ICT usage as a pedagogical tool in Nigerian TVET institutions so that it will change teachers attitude and practices by improving their professional practices. These, in turn, benefit the community as a whole.
- ii) Nigeria as a developing country receives donations of computers from non-governmental organizations, certainly the donor agencies may be willing to know the ways in which computers are being used. Therefore, this study will serve as an addition to the existing literature.
- iii) The current research findings serve as an extension to the existing body of knowledge on the use of ICTs as a pedagogical tool in the teaching of electronic courses.
- iv) The study also contributes to knowledge the main barriers that are hindering the successful use of ICTs in Nigerian TVET institutions.

### **1.10 Overview of Research Design**

In an effort toward addressing the research questions in this chapter. This section presents an overview of the research design used in this study. However, interpretive perspective underpinned this research. The fundamental philosophical assumption is that multiple realities are constructed socially through interactions (Merriam 1998). Within this paradigm, the effort is to understand and document relevant issues to the research purpose in the selected cases. Therefore, to obtain a snapshot of the reality through the activity system of ICT mediated teaching and learning, the study adopted a qualitative multiple case study approach as it encourages the study of a small number of cases (Ary, Lucy & Razviah, 2002). Secondly, multiple case study was chosen because it is a common strategy that allows generalizability of the findings (Merriam, 2009).

Thus, the use of multiple case study will increase the chance of identifying issues revolving around the use of ICTs as a pedagogical tool. It is believed that purposive sampling strategy is sufficient to provide insight and understanding of what is being studied (Ary *et al.*, 2002). A variation of purposive sampling called Maximum variation was used to select the institutions included in this research. According to Merriam, (1998) two levels of sampling strategy are usually essential in

qualitative case studies, these include the case to be examined, and some sampling within the case. In this regard, a variation of purposive sampling called homogeneous purposive sampling was used to select a sample of electrical/electronic teacher and their students. Figure 1.1 shows a framework for the research flow developed by incorporating various stages and strategies used in this research to realize the purpose of the study successfully.

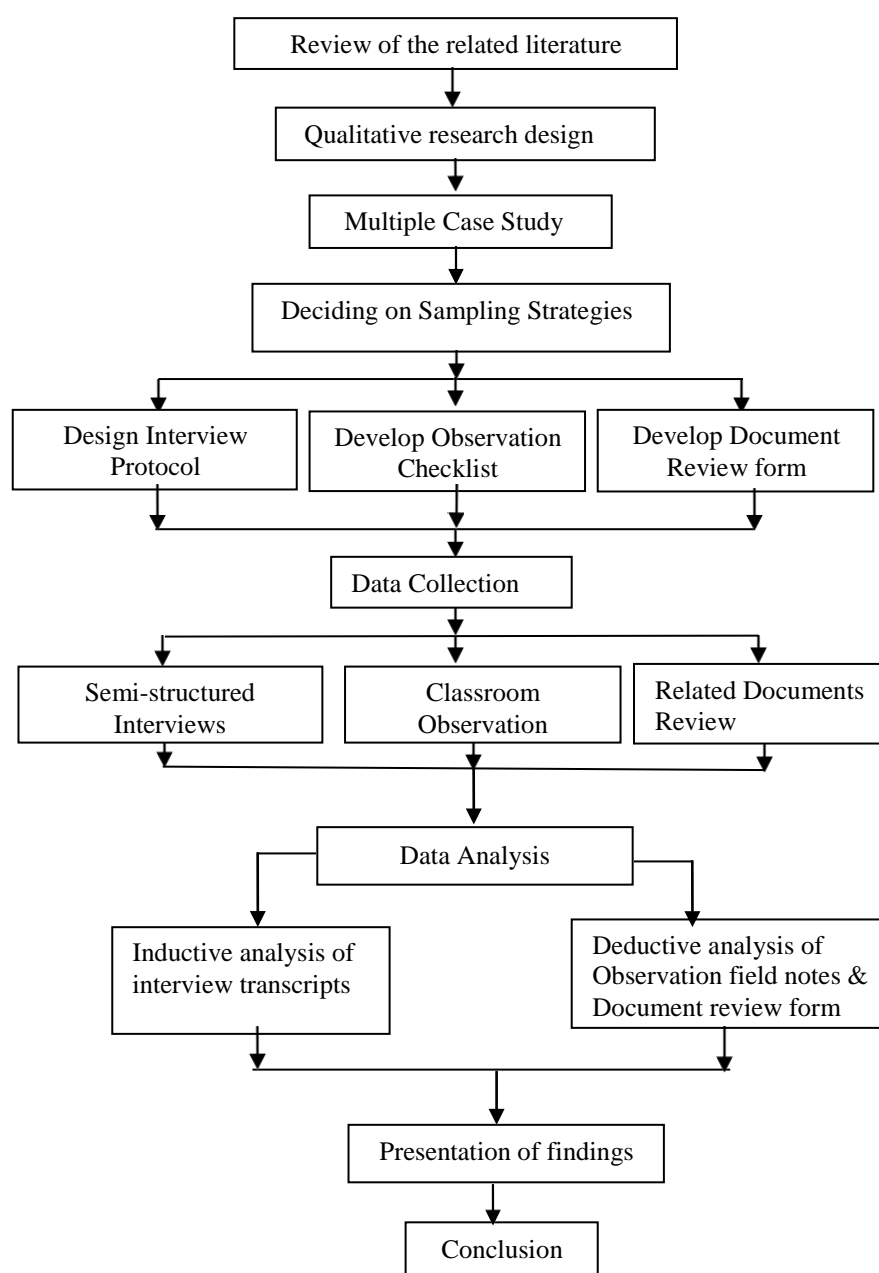

Figure 1.1: Research framework of the study

A total of ten (10) teachers handling electrical and electronics course and ten (10) of their student participated across the five institutions. The participants' selection was successful with the assistance of various heads of departments in the visited schools. To ensure privacy and for easy identification, both the schools and participants selected were given name codes. The codes and selection criteria were highlighted in chapter three. Semi-structured interviews, direct observation, and document review were used to obtain data in this study. Thus, the use of multiple sources of evidence is important as it allow data triangulation (Tobi, 2013), semi-structured interview was the primary source of data in this research, while observation and document review as a supplementary method.

The data were collected one case at a time to make the analysis to be easier (Bogdan & Biklen, 2007). To increase the reliability of the case study, a case study protocol has been developed to serves as a guide during data collection process (Yin, 1994). The five main questions on the interview protocol were further refined to develop an interview guide to enable a successful conduct of the semi-structured interview. In addition, observation checklist was also developed and used as a guide during observation process. The data obtained from observation was recorded on the developed field notes form, while the data obtained from document review was recorded on document review form for the purpose of analysis.

During the analysis stage of the interview transcripts, open and axial coding system of grounded theory methodology as proposed by Strauss & Corbin (1990) was employed, the coding process was achieved by utilizing the inherent future of NVivo10 software. Inductive approach was used to analyse interview transcripts, in this regard, themes are allowed to emerge from the data. While data from observation and document review was analysed in a slight shift to a deductive mode, this is to checked whether the themes and categories that emerged from the initial coding process exist in the subsequent data (Merriam, 2009). The interview and analysis process continued untill when the information gathered is repetitive (Onwuegbuzie, Dickinson, Leech & Zoran, 2009). Indeed, this is called data saturation level.



## **1.11 Structure of the Thesis**

This thesis is organized into five chapters, after the introductory section, this chapter present background of the problem and also problem statement that inform the direction of the study. The Chapter present the reasons for pursuing this research, and also the overview the research designed and methods adopted in this study. Chapter 2 examine the review of the related literature in which activity theory is presented as a theoretical framework that guided the study, Research designed and methods adopted for this study is discussed in Chapter 3. In addition, rationale and justification for taking such approach is presented, similarly, the chapter also provides detailed of data collection and analysis leading to the development of this study. Chapter 4 presents the findings obtained during the period of this study in within case, which is later recombined in to cross-case analysis to draw a common conclusion. Discussion of the research findings were presented in Chapter 5, this is towards answering the research questions based on the evidence of the data and literature. The chapter also outlines the contribution of the Research and also suggestion for further research.

## **CHAPTER 2**

### **LITERATURE REVIEW**

#### **2.1 Introduction**

Information and communication technology have impacted at a different level within which student and their teachers leave and interact (Jung, 2005). In a society like Nigeria, many factors affect its ICTs use and integration, the workplace is being compelled by the advanced development of new technologies. The advancements in information technology are bringing about significant changes in the way people live and work (Varghese, 2011). Therefore, ICT enhances lesson delivery and access to new knowledge, it improves the curriculum, and it produces richer learning outcomes (Hooker *et al.*, 2011).

The use of ICT in teaching as a pedagogical tool usually support traditional method of teaching by improving the quality of lecture and lecture materials through power point presentations and also interactive whiteboards (Beetham & Sharpe, 2013). Teaching and learning are essential characteristic of technical and vocational education institution (Chukwuedo & Omofonmwan, 2013), the use of ICTs is of paramount important. For learning to be successful, the practices of teaching and learning have to engage student attention so that they enjoy the study.

## 2.2 ICT and Education

As we are moving further into the second part of 21<sup>st</sup> century, the established academic institutions struggle to keep up with the different challenges as a result of new technologies (Webb, 2007). Hence, the need for students to learn how to seek out new information to meet up with the challenges of the dynamic environment. These technologies have marked the potential for knowledge distribution (Baskin & Williams, 2006). As pedagogical content knowledge differs from one subject to another, the choice and use of ICT resources will differ regarding educational practices for the different concepts. However, teachers beliefs, attitudes and their confidence with ICT remain relevant in the pedagogical adoption of ICT (Victoria, 2011). Teachers use of ICT in the teaching process depends on the organizational contexts in which they live. There is a need for pedagogical reasoning that provides teachers opportunities to make connections with their schools through constant access to ICT infrastructure. While, on the other hand, Saddam *et al.*, (in Barakabitze, 2014) stated that students perceptions change when they are exposed persistently to the capabilities of ICT.

It is part of the teachers beliefs that ICT form an important foundation stone for the way in which they expressed knowledge in the teaching process (Barakabitze, 2014). The participant added that once teachers found to be using ICTs, it is possible for student to develop better skills in ICT use, and that most of the teachers perceived ICT as beneficial because it makes teaching process easier. Hennessy, Harrison & Wamakote, (2010) further reported that there were a lot of factors hindering teachers successful use of ICT in the teaching process. Among others were, lack of expertise and teachers in using ICT, lack of technical support in the schools, lack of incentives and support for teachers were the noticeable factors hindering teachers readiness and confidence in using ICT.

The situation is also the same in Nigerian context. Among other barriers to ICT integration in Nigerian universities were Lack of teacher's confidence, Lack of teachers competency due to lack of time for training (Yusuf, 2005a). The education institution cannot continue to survive with such challenges. According to Hennessy, Hennessy *et al.*, (2010), it is a necessity for teachers to determine which of ICT applications specifically have additional value for their pedagogical practices.

## **2.4 Understanding Pedagogy**

Pedagogy is a structured process whereby a culturally more experienced teacher uses helpful tools to mediate or guide a learner into reliable ways (Hardman, 2007). He further stressed that pedagogy refers to any conscious activity designed by one person to bring about learning in another and capable of providing motivation, and to make student journey successful to a particular productive end they need (Beetham & Sharpe, 2013). However, no common approach suits all teaching and learning situations, such issue necessitates competent teachers to use different strategies as possible in various combination to teach a diverse group of learners to improve their learning outcome (Bhowmik, Banerjee, & Banerjee, 2013). There is the need to develop active pedagogies by creating a student-centered learning environment that will encourage and ensure student support to take control of their learning (Ruthven, Hennessy, & Deaney, 2005).

It is also the teacher's responsibility to ensure that all students are engaged intellectually regardless of their background. Using balanced theoretical framework teachers will be able to reflect critically on their work with colleagues which is term as productive pedagogies. According to Bhowmik, *et al.*, (2013), pedagogy should incorporate strategies that support intellectual engagement, recognition of learners differences and supportive to classroom environment across all subject and key learning areas. Therefore, pedagogical practices should be a concern for teachers, school administrators, education systems and local communities.

### **2.4.1 Pedagogy and the use of ICT**

For the past few years, pedagogical practice with digital learning resources as well as teachers 'attitudes towards the use ICT resources for lesson planning and delivery are becoming more confident. According to Vanderlinde & van Braak (2010). The new technologies generate a different kind of relationship between the teacher, the learner and what is to be learned. Inevitably the scope and style of pedagogy change as the technology changes, however, none of the new technologies can improve individual learning ability but they change how ideas and practices are being communicated

(Beetham & Sharpe, 2013). Moreover, according to Beetham & Sharpe, (2013), some progress were considered a pedagogical change.

- i) Understanding that teaching and learning are independent aspects of a single activity from the previous view of teaching and learning as complementary activities.
- ii) From a sequential to an organic structuring of learning experiences.
- iii) To communicative from individualized learning.
- iv) Teacher's view role as an organizer of learning activities to one as a shaper of quality learning experiences.
- v) The knowledge that teaching needs to be suited to individuals, which requires regular self-monitoring to ensure sensitivity to unintended discrimination forms of bias.
- vi) A view of learning context as a supportive, interactive, whole school culture. Unlike the when the was confined to the classroom and controlled by the teacher.
- vii) A view of technology as it provides ideas, and sometimes providing a resource for inquiry, and sometimes supporting creativity, unlike the previous view of technology as either a tutor or a tool.

Considering how ideas are communicated in different subject areas, the teacher must have pedagogical knowledge relating to their subject areas, in this situation electrical and electronic as a course of study is not in exception to such need. Teachers need to change their roles and class organization they also need preparing managing new learning arrangements (Ndibalema, 2014). Hennessy et al., (2010) pointed out that teachers perceive the use of ICT for enhancing learning, providing new motivations, activating learner's response. The study by Condie and Livingston (2007) point out that a quite good number of teachers perceive that the use of new technologies might have an adverse impact on examination results.

As a consequence, such issues serve as a barrier to the successful ICT integration in education. Research findings by Mlambo (2007) on ICT in physic teaching and learning in Manicaland Zimbabwe, revealed the absence of a good example of best practices in the use of ICTs in teaching physics, the findings showed that few teachers remembered when last they typed lecture notes for their students. The findings also revealed that a quite good number of physics teachers were found using traditional instructional methods. Ndibalema (2014), suggested that without using ICTs, teachers need too much time to assess, and revise learning materials.

However, in a research study by Jaji (2008) he found that tools such as the Internet, Digital cameras, video, video cameras and video players were used in teaching as pedagogical tools to make teaching and learning easier.

#### **2.4.2 Pedagogy in the Teaching of Electronics**

It is the responsibility for efficient pedagogical practices to promote the well-being of the student as well as the school community (Bhowmik *et al.*, 2013). Learning is a process through which we acquire knowledge, skills, and competencies. According to Chukwuedo & Omofonmwan (2013), teaching and learning is a characteristics of technical and vocational education and training. Therefore, to succeed in the teaching practices students have to be engaged, the knowledge and skills they need must link to their interest. The quality of lesson delivery can be improved through the use of PowerPoint presentation and using interactive whiteboards across all subject and key learning areas. It is further recommended that pedagogy should incorporate teaching strategies that support intellectual engagement and supportive to the classroom activities (Bhowmik, *et al.*, 2013).

Therefore, the teaching of electrical/electronic concepts is difficult through the traditional classroom setting due to the nature of abstract notion that include voltage, current, capacitance, and resistance (Chukwuedo & Omofonmwan, 2013). Therefore, student in such disciplines have the problem of understanding, especially in dealing with current and voltages. Hence, the need for teachers pedagogy to combine different teaching strategies to inculcate adequate skills, attitude, and values to the individual learners (Chukwuedo & Omofonmwan, 2013). It is evident that educational institutions cannot impart necessary skills required especially in the field of electrical/electronics without proper teaching skills.

#### **2.5 ICTs in the Teaching of Electronics**

If teacher in technical and vocational education are to be part of the dynamic learning environment, then training and retraining in ICT skills is inevitable (Hooker *et al.*, 2011). ICTs help in lesson delivery and make education and information accessible

to whoever needs it Iloanusi & Osuagwu (In Hooker *et al.*, 2011). Considering several disciplines within the TVET programme, ICT facilities should be used to support teaching and learning processes (Chukwuedo & Omofonmwan, 2013). These include electrical/electronic technology, some of the contents include semiconductor devices, circuit theory analysis, electrical installation, digital logic circuits, electrical devices and machines, electronic communication among others.

Teaching and learning in TVET programme cannot be restricted to traditional classroom settings especially in the teaching of electrical/electronics, but should adopt acceptable technological dynamism to become very productive in teaching process through the use of ICTs (Chukwuedo & Omofonmwan, 2013). In the process of ICT utilization, the student participates actively and pays maximum attention, their interest rose rapidly in the learning process (Ambikairajah, Sheng, Celler & Che, 2005). Considering the abstract nature of the notion such as frequency, voltage, and current, they were only made observable through animation simulation and measurements in the teaching processes to explain and describe abstract content for better student understanding (Fedak & Bauer, 2005). However, there are different types of simulation software. Thus, Multisim is one of the most commonly used simulation software.

### **2.5.1 Multisim Simulation Software**

Multisim is simulation software for circuit designers and researchers, Multisim as design software gives engineers advanced analysis and design experiences to enhance their performance, significant cost savings and reduce design errors. Foundational concepts in both analogs, digital, and power electronics through the use of Multisim simulation software. Figure 2.1 on page 18 shows a Multisim simulation software install on an ordinary desktop window.

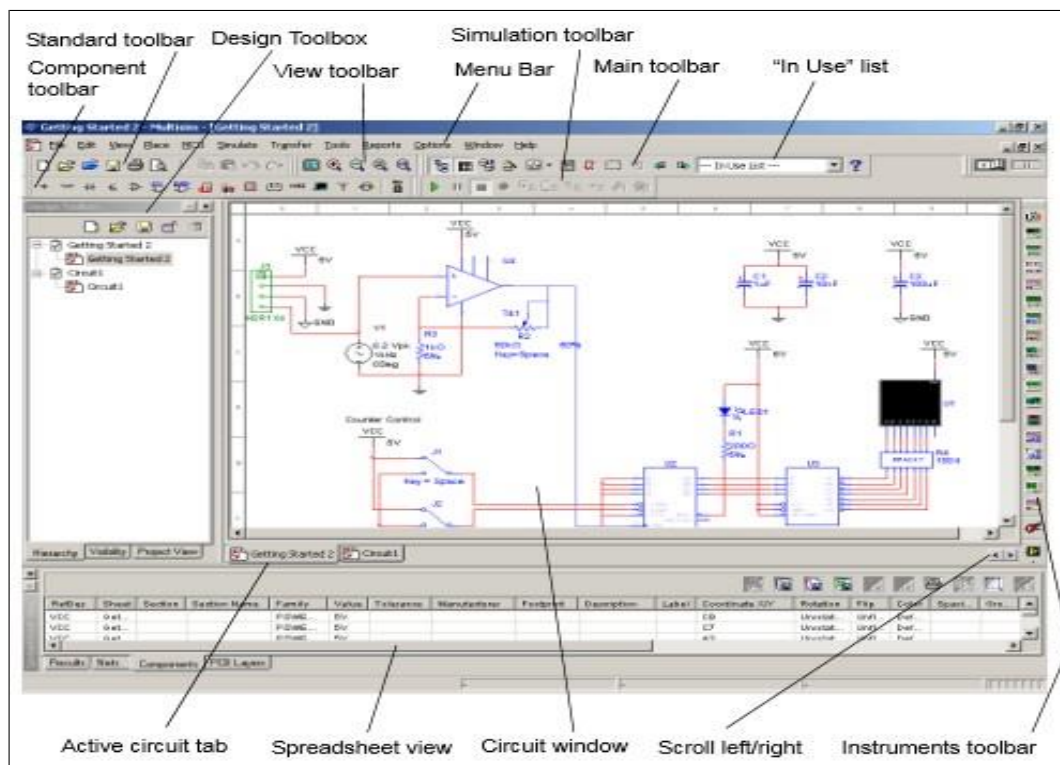

Figure 2.1: Multisim Software install on an ordinary window.  
Source: Kumar, Pattanayak & Singh, (2009)

Simulation has been done several times in power electronics devices, starting from the primary circuits consisting of diodes, thyristors, resistors, capacitors just to mentioned few. In this regard, different voltages and current responses are shown on the graph (Kumar, *et al.*, 2009). For example to have an insight into current commutation in rectifiers, the effect of a finite Alternating current side inductance ( $L_s$ ) on the circuit operation, while the direct current side ( $I_d$ ) as shown in the circuit diagram given below. Due to finite Alternating current side inductance ( $L_s$ ), the transition of the alternating current-side, current is from a voltage  $+I_d$  to  $-I_d$  or vice versa will not be instantaneous. The finite time interval required for such transition refers to current commutation time. Such process where the current conduction shifts from one diode to the other is called the current commutation process. An example depicting the core concept is shown in Figure 2.2 on page 19.



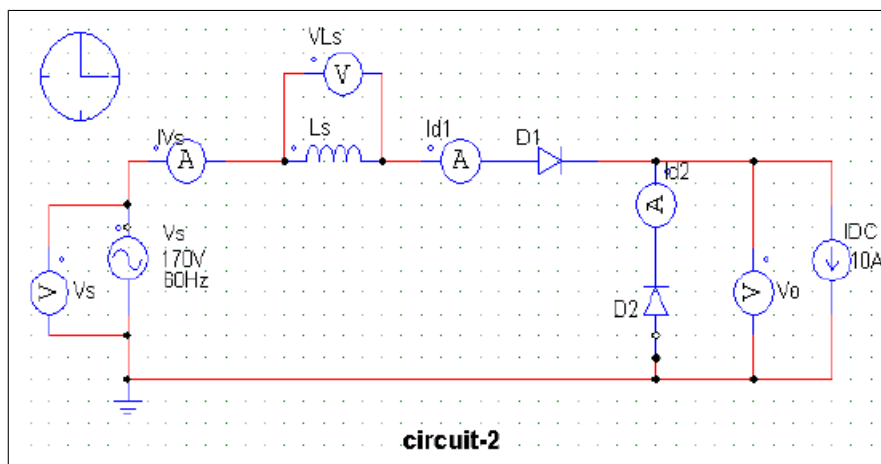

Figure 2.2: The basic concept of current commutation in rectifiers.  
Source: Kumar, Pattanayak & Singh, (2009)

To make some of such concepts easy for learners better understanding, particularly on the abstract notion of voltage and current. A Multisim simulation software was used to draw a circuit, the output generated is usually displayed in the form of graphs. Both current and voltage responses are shown in different colors, the example of two graphs are shown in Figure 2.3.

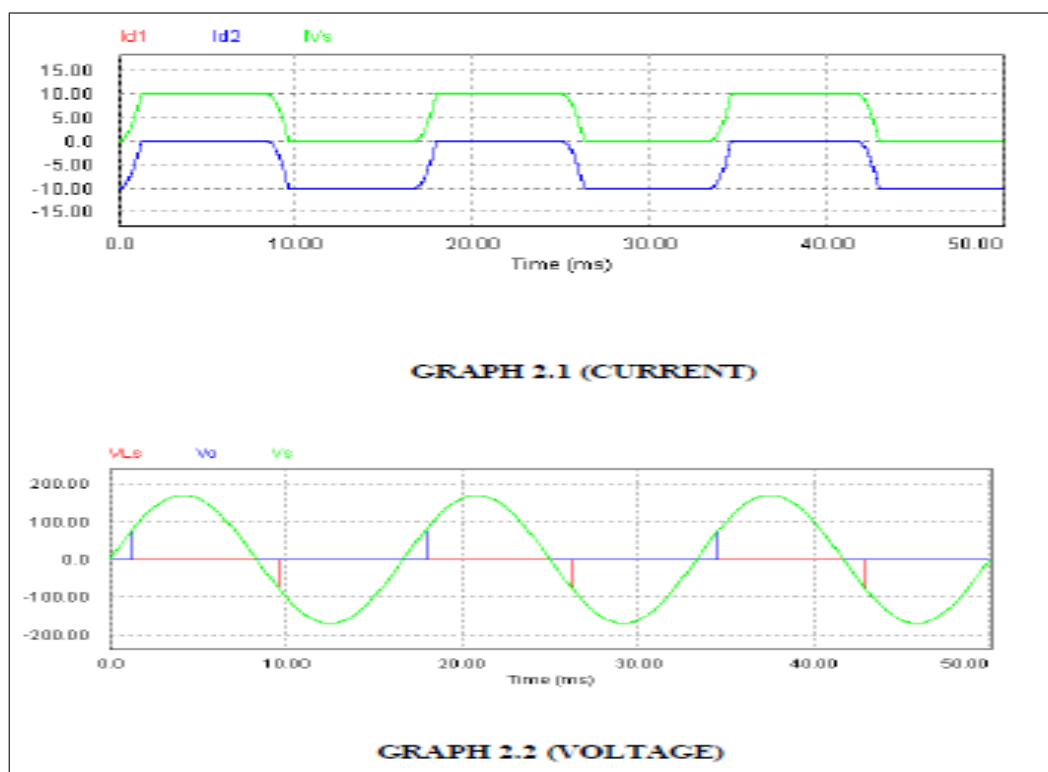

Figure 2.3: Basic concept of current commutation in rectifiers Graph for Current and Voltage. Source: Kumar, Pattanayak & Singh, (2009)

As electronic technology is becoming a dominant force in today's society. It has to do with all corners of science and engineering. The widespread application electronic devices make it imperative for a student to obtain a practical familiarity with electronics (Kumar *et al.*, 2009). Considering the basic concept of rectification through the diode, alternating input voltage is converted into direct output voltage through the diodes. Perhaps, such rectification process may not be well understood by the use of chalk and board method. Thus, the circuit was designed and tested using multisim simulation software to capture students mind, showing the students what has transpired throughout the rectification process. An example of the designed circuit and a graph obtained is shown in figure 2.4.

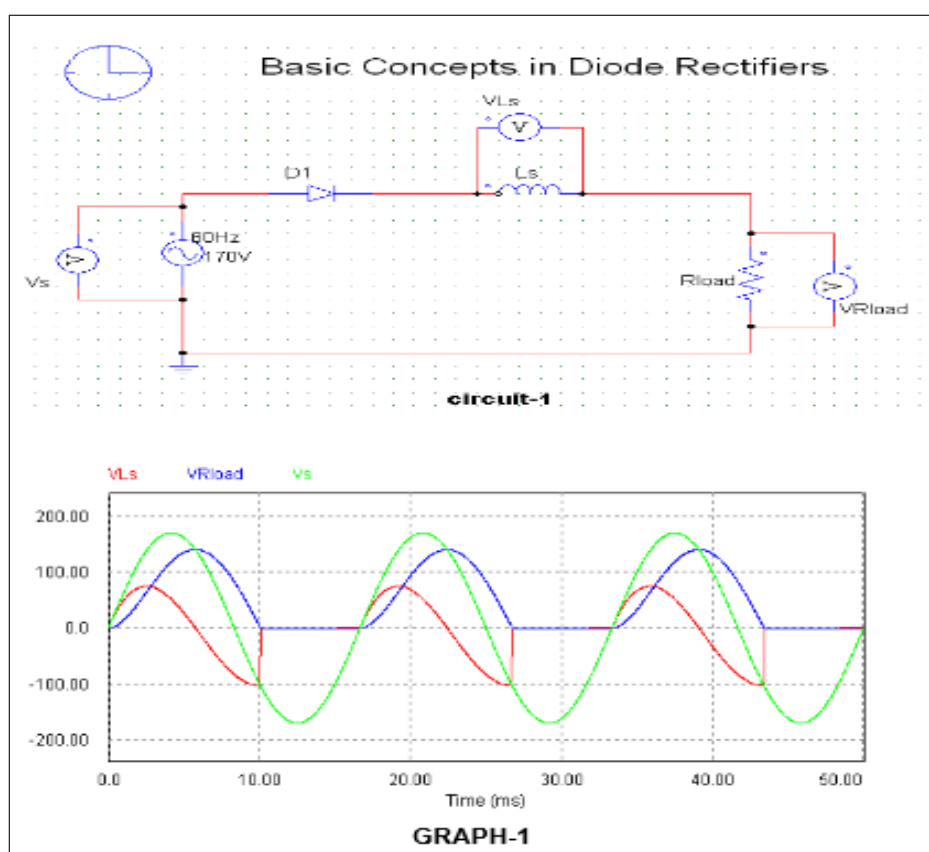

Figure 2.4: Line Frequency Diode Rectification Circuit.  
Source: Kumar, Pattanayak & Singh, (2009)

The majority of the power electronics applications used switching of direct current (DC) power supplies, and alternating current (AC) motor drives use uncontrolled rectifiers input power of 50 to 60 Hz sine wave AC voltage provided by the electric utility, the AC voltage is converted to a DC voltage. Therefore, using rectifiers with

diodes, the power flow can be only from the utility AC side to the DC side. This process promotes student understanding of the basic concept of Diode Rectification through manipulative skills that enable the learner to retain what he learned for a very long time. According to Chukwuedo & Omofonmwan (2013), skills acquired in electrical/electronics programme enables students to display related skills when the need arises for electrical/electronics tasks or challenges. For teachers to successfully deliver their lesson, ICT facilities must be put to use to support the teaching and learning process. Kumar *et al.*, (2009) clearly revealed that electrical/electronics as technology education course contribute and help young graduate to prepare to live and work in the digital world. Through such processes, learners are encouraged to make use of several tools and material in an ethical and responsible way. It is evident that such ICT facilities has impacted significantly on teachers pedagogical practices in the teaching of electronics concepts.

### **2.5.2 Electronic Logic Gates**

It is obvious that calculator and computers store decimal numbers 0 to 9 in the form of binary codes, each number is stored using electronic switches called transistors. The binary numbers are easily stored by switching transistors on and off a transistor. Thus, turning on a transistor stores a number one (1), while switching it off stores a zero (0) (Woodford, 2013). While addition, subtraction, multiplication, and division are usually achieved using electric current. Indeed, calculators and computer perform such operations through the use of electronic circuits called logic gate. These logic gates are electronic circuits with two inputs and an output, it receives two incoming electric currents, compare them and produce an output depending on the type of the logic gate.

However, according to Wakerly (2000), such logic gates are the most basic digital devices. Each segment of a calculator display is switched on and off by a series of logic gates connected together. Therefore, different combinations of logic gates control how the display figure out the result of the calculation. If patterns of binary numbers are fed into the four inputs on the left, each one of the segment will turn on and off correctly. For example, if number seven (7) is fed into a gate as the

four inputs binary 0111, the gates will trigger and correctly switch on a particular segment as shown in figure 2.5.

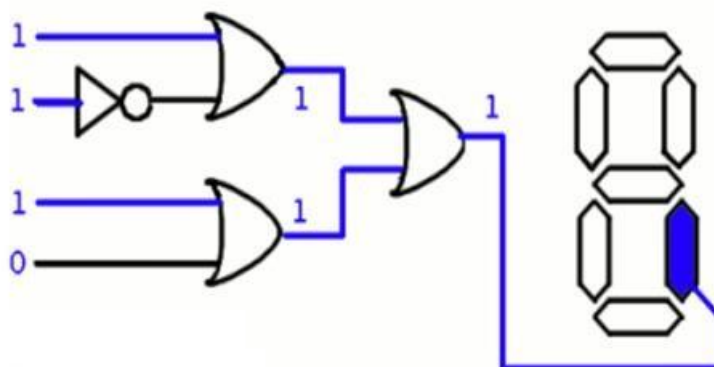

Figure 2.5: Combination of logic gates switching a segment.  
Source: Woodford, (2013)

Different type of Logic gates includes: AND, OR, XOR (Exclusive), NOT, NOR, which is obtained by combination of NOT, OR, and NAND by combining NOT, and AND. These logic gates have different characteristics. For example, AND gate work with two electrical inputs, and if both inputs are switch on, that is carrying number one (1), the output will be one as well. While NOT gate operated contrary to the way AND gate operate, the NOT gate has only one input and one output, the output is exactly the opposite of the input. In this regard, if the input is zero (0), the output is one (1) and vice versa. The gates compare and combine two series of binary numbers corresponding to the decimal numbers in the calculation, and produce a new set of binary numbers equal to the result (Wakerly, 2000). However, it is possible for any calculation to be achieved by combining different pattern of logic gates.

### 2.5.3 Quartus II Software

Electronic logic gates are designed on Quartus II software, each electronic logic circuit designed on such software is called a project. Therefore, the software works on only one project at a time and keeps all information about a particular project in a single folder. This type of software is usually installed on a typical computer window that provides display and access to all its features (Ahmad, 2015). In this regard, the components that will be used in the project are selects through a computer mouse,

and most of its commands can be accessed by using a set of menus that are located below the title bar. Figure 2.6 shows how the combination of logic gates was compiled in a schematic diagram.

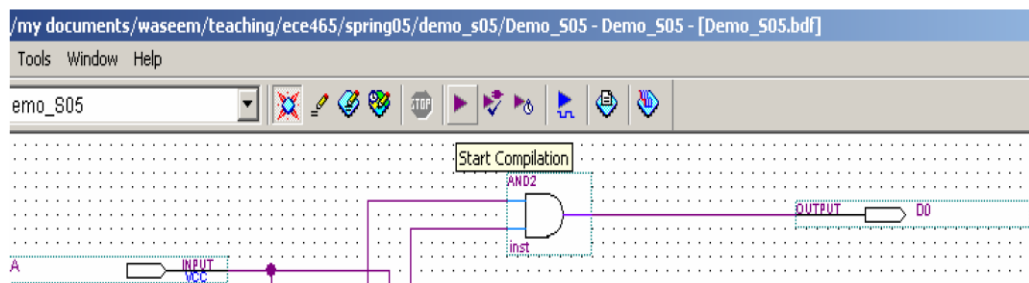

Figure 2.6: Compiled schematic design.  
Source: Ahmad, (2015)

Having entered the logic gate symbols into the design environment, it is necessary to enter the symbols that represent the input and output ports of the circuit, these are also achieved through the same procedure use to import the gates. All nodes are connected with wires by clicking to activate the orthogonal node tool on the toolbar. It is important to simulate a design circuit to ascertain its correctness, it is necessary to create the desired waveforms called test vectors to represent the input signals which is achieved through the use of simulation waveform editing tool. Secondly, it is also necessary to specify which outputs, as well as possible internal points in the circuit Ahmad, (2015). Such simulation result is shown in figure 2.7.

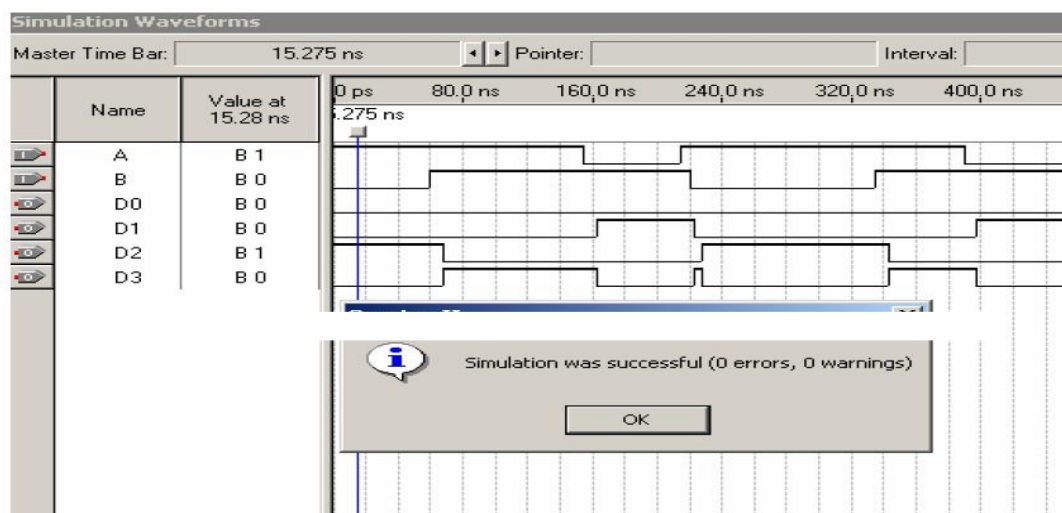

Figure 2.7 Functional simulation results.  
Source: Ahmad, (2015)

Once the simulation is successful, the output waveforms corresponding to output pins on the vector waveform file is visible as shown in Figure 2.7 above (Ahmad, 2015). If there is, at least, one mistake in the schematic entry, Quartus II software displays error messages produced during compilation, in this case, a message corresponding to each error found will be displayed in the messages window. In this regard, the offending part of the circuit in the graphic editor window will be highlighted by clicking on the error message, thereby, the error can be corrected, and the design is recompiled. One of the messages will state that the compilation was successful if there are no errors, and the block diagram design file is correct.

## **2.6 Influences of ICTs on Teachers Practice and Students Learning**

As information and communication technologies get it way into the education system, it is difficult for established academic institutions to remain unchallenged. Empirical research revealed that ICTs plays a vital role in high-quality teaching and learning. Developments in technology have opened up new opportunities for several techniques in which teachers deliver their lesson. The skills that mostly influenced teachers' uses of ICTs were those related to the teachers competence in managing classroom activities (Mumtaz, 2000). Some factors were found to be the most important to the teachers in their teaching practices, among others were making the lessons more interesting, easier, more fun, more motivating for the student and enjoyable. Mumtaz further added that implementing change in education must include changing teacher's practice and beliefs

Thus, study findings by Barakabitze, (2014) shows that using ICTs enable students a constant search for relevant information and other instructional materials, it also facilitates effective communication among students. As a result of ICT utilization, students are now more often engaged in the use of computers. Report by UNESCO, (2008) indicates that ICTs promote student-centred learning, as well as an educational change in all learning institution. With the recent discovery of new multimedia tools, student creativity can be enhanced through maximum utilization (Barakabitze, 2014). Learning institutions reported a lack of ICT policies which is considered as a significant challenge (Oroma, Kiden, Maghendha & Ntiyani, 2013). ICTs enables communication among students, facilitate the search for relevant

## REFERENCES

- Achimugu, P., Oluwagbemi, O., & Oluwaranti, A. (2010). An evaluation of the impact of ICT diffusion in Nigeria's higher educational institutions. *Journal of Information Technology Impact*, 10(1), 25-34.
- Adeosun, O. (2010). Quality basic education development in Nigeria: Imperative for use of ICT. *Journal of International Cooperation in education*, 13(2), 193-211.
- Adeoye, B. F., & Olabiyi, O. S. (2011). *Basic Technology Textbooks in Nigerian Secondary Schools: A Quality and Content Analysis*. 14(2), 153-168.
- Adomi, E. E. (2005). Internet development and connectivity in Nigeria. *Program*, 39(3), 257-268.
- Aduwa-Ogiegbaen, S. E., & Iyamu, E. O. S. (2005). Using information and communication technology in secondary schools in Nigeria: Problems and prospects. *Journal of Educational Technology & Society*, 8(1), 104-112.
- Afeti, G. (2012). Technical and vocational education and training for industrialization. *African Research*.
- Ahmad, W. (2015) Altera Quartus II Tutorial for ECE 465 student at UIC. Retrieved on November- 17- 2015 from [http://islwww.epfl.ch/pages/teaching/cours\\_sl/sl\\_info/Labo5.a.pdf](http://islwww.epfl.ch/pages/teaching/cours_sl/sl_info/Labo5.a.pdf)
- Ainley, J., Enger, L., & Searle, D. (2008). Students in a digital age: Implications of ICT for teaching and learning. *International handbook of information technology in primary and secondary education*, Springer US. (pp. 63-80).
- Ajisebutu, W. (2010). *21st Century Technologies – A dream Nurtured by Integrity*. Retrieved on April-15-2014 from [http://www.21ctl.com/a\\_dream\\_nurtured\\_by\\_integrity.php](http://www.21ctl.com/a_dream_nurtured_by_integrity.php).
- Almadhour, B. (2010). *The integration of information and communication technology into secondary technology teachers' pedagogy in New Zealand*. Auckland University of Technology: Ph.D. Thesis.

- Ambikairajah, E., Epps, J., Sheng, M., Celler, B., & Che, P. (2005, March). Experiences with an electronic whiteboard teaching laboratory and tablet PC based lecture presentations [DSP courses]. In *Acoustics, Speech, and Signal Processing, 2005. Proceedings. (ICASSP'05). IEEE International Conference on 5*, pp. v-565). IEEE.
- Anfara, V. A., Brown, K. M., & Mangione, T. L. (2002). Qualitative analysis on stage: Making the research process more public. *Educational researcher*, 31(7), 28-38.
- Ani, O. E., Esin, J. E., & Edem, N. (2005). Adoption of information and communication technology (ICT) in academic libraries: a strategy for library networking in Nigeria. *The Electronic Library*, 23(6), 701-708.
- Apulu, I., & Latham, A. (2009). Information and communication technology adoption: Challenges for Nigerian SMEs. *TMC Academic Journal*, 4(2), 64-80.
- Ary, D. Lucy, C. J., Razviah, A. (2002). *Introduction to research in education*. 6<sup>th</sup> ed. united state: library of congress. *At a Round table Organized by civil Society Action Coalition on Education for all (CSACEFA)*.
- Atchoarena, D., & Delluc, A. (2002). *Revisiting Technical and Vocational Education in Sub-Saharan Africa: An Update on Trends, Innovations and Challenges. New Trends in Technical and Vocational Education*. UNESCO-IIEP, Socit Gnrale, 10 rue Thenard 75005 Paris, France.
- Ates, A. (2008). *Strategy Process in Manufacturing SMES*. University of Strathclyde Glasgow UK: Ph.D. Thesis.
- Bada, T. A., Oyewusi, L., Ojedokun, O., & Adewole, A. (2010). Uses of computer and its relevance to teaching and learning in Nigerian educational system. *African Research Review*, 4(1).
- Bapir, M. (2014). Is it possible for qualitative research to be properly valid and reliable, University of Warwick.
- Bappa-Aliyu, M. (2012). Integrating e-learning in technical and vocational education: a technical review. *International Journal of Academic Research in Business and Social Sciences*, 2(5), 52-58.
- Barakabitze, A. A. (2014). The Context of Education Initiatives, Importance and Inhibitors of ICTs towards improving teaching and learning in Tanzania: A Critical Literature review. In *Information and Knowledge Management*. 4(10), pp. 83-97.
- Baskin, C., & Williams, M. (2006). ICT integration in schools: Where are we now and what comes next. *Australasian Journal of Educational Technology*, 22(4).



- Becta, (2004). *A Review of the Research Literature on Barriers to the Uptake of ICT by Teachers*. Retrieved on may-16-2014 from [http://partners.becta.org.uk/page\\_documents/research/barriers.pdf](http://partners.becta.org.uk/page_documents/research/barriers.pdf).
- Beetham, H., & Sharpe, R. (2013). *Rethinking pedagogy for a digital age: Designing for 21st century learning*. Routledge.
- Bhowmik, M., Banerjee, B., & Banerjee, J. (2013). Role of pedagogy in effective teaching. *Basic Res J Educ Res Rev*, 2(1), 1-5.
- Bingimlas, K. A. (2009). Barriers to the successful integration of ICT in teaching and learning environments: A review of the literature. *Eurasia Journal of Mathematics, Science & Technology Education*, 5(3), 235-245.
- Bogdan, R. C. and Biklen S. K. (1998) *Qualitative research for education an introduction to theory and methods*. 2<sup>nd</sup> ed. united states: library of congress.
- Bogdan, R. C., & Biklen, S. K. (2007). *Research for education: An introduction to theories and methods*. New York: Pearson.
- Boyce, C., & Neale, P. (2006). *Conducting in-depth interviews: A guide for designing and conducting in-depth interviews for evaluation input* (pp. 3-7). Watertown, MA: Pathfinder International.
- Chai, C. S., Koh, J. H. L., & Tsai, C. C. (2010). Facilitating preservice teachers' development of technological, pedagogical, and content knowledge (TPACK). *Journal of Educational Technology & Society*, 13(4), 63-73.
- ChanLin, L. J., Hong, J. C., Horng, J. S., Chang, S. H., & Chu, H. C. (2006). Factors influencing technology integration in teaching: A Taiwanese perspective. *Innovations in Education and Teaching International*, 43(1), 57-68.
- Chukwuedo, S. O., & Omofonmwan, G. O. (2013). Information and communication technology: The pivot of teaching and learning of skills in electrical and electronics technology programme in Nigeria. *International Journal of Vocational and Technical Education*, 5(6), 117-123.
- Cohen, D., & Crabtree, B. (2006). *Qualitative Research Guidelines Project*. Robert wood Jonhson foundation. Retrieved on December-14-2014. [Http://www.sswm.info/sites/default/files/reference\\_attachments/cohen%202006%20semistructured%20interview.pdf](Http://www.sswm.info/sites/default/files/reference_attachments/cohen%202006%20semistructured%20interview.pdf)
- Cohen, L., Manion, L., & Morrison, K. (2000). *Research Methods in Education* 5th ed. London: Routledge Falmer. *Teaching in Higher Education*, 41.
- Condie, R., & Livingston, K. (2007). Blending online learning with traditional approaches: changing practices. *British Journal of Educational Technology*, 38(2), 337-348.

- Cooper, D. R. & Shindler, P. S. (2003). *Business Research Methods*. 8th Ed. New Delhi: India.
- Cresswell, J. W. (2009). *Research Design: Qualitative, Quantitative, and Mixed Methods Approaches*. 3<sup>rd</sup> ed. Los Angeles: Sage Publications.
- Creswell, J. W. (2012). *Planning, conducting and evaluating Quantitative and Quantitative Research*. 4<sup>th</sup> ed. University of Nebraska-Lincoln.
- Creswell, J. W. (2013). *Research design: Qualitative, quantitative, and mixed methods approaches*. 4<sup>th</sup> ed. Sage publications.
- Creswell, J.W. (2007). *Qualitative inquiry and research design, choosing among five traditions*. 2<sup>nd</sup> ed. Thousand Oaks, CA: Sage.
- De Wet, C. F. (2006). Beyond Presentations: Using PowerPoint as an Effective Instructional Tool. *Gifted Child Today*, 29(4), 29-39.
- Denzin, N.K. & Lincoln, Y. (2000). *Introduction: The discipline and practice of development, administration and personal use. International Journal of Education and Development using Information and Communication Technology*. 7(3), 36-49.
- Farhat, N. (2008). *The impact of technology on teaching and Learning in high schools in the united arab Emirates*. University of Leicester United Kingdom: Ph.D. Thesis.
- Farrell, G., Isaacs, S., Trucano, M., Hamdy, A., Hare, H., Tetang Tchinda, J., & Fall, B. (2007). *Survey of ICT in Education in Africa, Volume 2: 53 Country Reports*. Retrieved March-15- 2015 from <http://www.infodev.org/en/Publication.353.html>
- Fedak, V., & Bauer, P. (2005, September). E-learning in education of electrical drives and power electronics: opportunities and challenges. In *International Conference on Electrical Drives and Power Electronics*. pp. 26-28.
- Federal Ministry of Education, (2010a). *National Policy on Information and communication Technologies (ICT) in Education*. Abuja. FME.
- Federal ministry of Finance (2014) Retrieve Monday March 2015 <http://www.fmf.gov.ng/the-media/press-release/171-budget-2014.html>
- Federal Republic of Nigeria, (2001) Nigeria National Policy for Information Technology (IT). Retrieved on March-14-2013, from <http://www.nitda.gov/docs/policy/ngitpolicy>
- Federal Republic of Nigeria, (2004). *National policy in education*. 4th ed. Lagos: NERDC Press.

- Ferreira, C., Baptista, M., & Arroio, A. (2013). Teachers' pedagogical strategies for integrating multimedia tools in science teaching. *Journal of Baltic Science Education*, 12(4), 509-524.
- Fetherston, T. (2007). *Interpretivism And Constructivism Essays and Term Papers* retrieved on February-12-2014 from <http://www.studymode.com/subjects/interpretivism-and-constructivism-page1.html>
- Flick, U. (2009). *An introduction to qualitative research*. Sage.
- Galloway, C. A. (2001). Vygotsky's learning theory. *Emerging Perspective on Learning, Teaching and Technology*. Retrieved on November-02-2014 <http://www.coe.uga.edu/epltt/vygotskyconstructivism.htm>.
- Gibbs, G. (2002). *Qualitative data analysis: Explorations with NVivo (Understanding social research)*. Buckingham: Open University Press.
- Given, L. M. (Ed.). (2008). *The Sage encyclopaedia of qualitative research methods*. Sage Publications.
- Goro, C. A. (2012). The role and the challenges of information and communication technology (ICT) for Technology Teacher Educators in Nigerian colleges of education *Nigerian journal of Technology Teacher Education* 3(4) pp.1-5.
- Grbich, C. (2012). *Qualitative data analysis: An introduction*. Sage.
- Guba, E. G. (1981). Criteria for assessing the trustworthiness of naturalistic inquiries. *ECTJ*, 29(2), 75-91.
- Guba, E. G., & Lincoln, Y. S. (1994). Competing paradigms in qualitative research. *Handbook of qualitative research*, 2(163-194).
- Gurdial Singh, R. K., & Jones, M. L. (2007). Qualitative data analysis: making new discoveries and aligning old strategies. *Faculty of Commerce-Papers*, 425.
- Hardman, J. (2007). An Activity Theory approach to surfacing the pedagogical object in a primary school mathematics classroom. *Outlines. Critical Practice Studies*, 9(1), 53-69.
- Hardman, J. (2008). Researching pedagogy: An activity theory approach. *Journal of Education*, 45, 65-95.
- Hashim, N. H., & Jones, M. L. (2007). Activity Theory: A framework for qualitative analysis. *Faculty of Commerce-Papers*, 408.
- Hennessy, S., Harrison, D., & Wamakote, L. (2010). Teacher factors influencing classroom use of ICT in Sub-Saharan Africa. *Itupale online journal of African studies*, 2(1), 39-54.

- Hohlfeld, T. N., Ritzhaupt, A. D., Barron, A. E., & Kemker, K. (2008). Examining the digital divide in K-12 public schools: Four-year trends for supporting ICT literacy in Florida. *Computers & Education, 51*(4), 1648-1663.
- Hollander, A., & Mar, N. Y. (2009). Towards achieving TVET for all: The role of the UNESCO-UNEVOC international centre for technical and vocational education and training. In *International handbook of education for the changing world of work* (pp. 41-57). Springer Netherlands.
- Hooker, M., Mwiyeria, E., & Verma, A. (2011). ICT Competency Framework for Teachers in Nigeria. World Bank and GESCI initiative.
- Idris, A. (2015). Integrating Technical/Vocational Education and Training (TVET) and Open and Distance Learning (ODL): a Strategy for Delivering Skills Training to the Doorstep of Nigerians.
- Igbuzor, O. (2008). The State of Education in Nigeria. *A keynote Address Delivered at a Round table Organized by civil Society Action Coalition on Education for all (CSACEFA)*.
- Inan, F. A., & Lowther, D. L. (2010). Laptops in the K-12 classrooms: Exploring factors impacting instructional use. *Computers & Education, 55*(3), 937-944.
- Intel Corporation (2007). *White Paper Bridging the Digital Divide in Nigeria*. All rights reserved. Retrieved on Jun-18- 2014 from [www.intel.com/worldahead](http://www.intel.com/worldahead).
- Iskander, M. (Ed.). (2007). *Innovations in E-learning, instruction technology, assessment and engineering education*. Springer Science & Business Media.
- IWS monthly Newsletter, (2015) Internet World Start, usage and population statistics The Internet coaching library. Retrieved on February-18-2015 from <http://www.internetworldstats.com/top20.htm>
- Jaji, M. (2008). Trends and barriers on the integration information and communication in the Nigerian school system, *Nigerian journal of Technology Teacher Education* 1(1) pp.101-110.
- Jaji, M. Abubakar, B. (2012). The effect of instructional Technology on teaching and learning in Nigerian secondary school *Nigerian journal of Technology Teacher Education* 3(1) 137-143.
- Jegade, P. O. (2009). Assessment of Nigerian teacher educators' ICT training. *Issues in Informing Science and Information Technology, 6*, 415-420.
- Jung, I. (2005). ICT-pedagogy integration in teacher training: application cases worldwide. *Journal of Educational Technology & Society, 8*(2), 94-101.

- Khan, S. M. (2011). *Comparative Analysis of Teacher Education Programmes in Pakistan and UK*, Doctoral dissertation, Sarhad University of Science and Information Technology.
- Kumar, S., Pattanayak, B., & Singh, R. S. (2009). *Power Electronics: Computer Simulation and Analysis*. Deem University. Rourkela India: PhD. Thesis.
- Lawal, A. W. (2014). Technical and vocational education, a tool for national development development in Nigeria. *International Letters of Social and Humanistic Sciences*, (03), 53-59.
- Lim, C.P. (2002). A theoretical framework for the study of ICT in schools: A proposal. *British Journal of Educational Technology*, 33(4), 411–421
- Lincoln, Y. S., Lynham, S. A., & Guba, E. G. (2011). *Paradigmatic controversies, contradictions, and emerging confluences, revisited*. The Sage handbook of qualitative research, 4, 97-128.
- Malgwi, A. P. Mbah, C. O. (2012). Entrepreneurial prospects in the metal working industry A challenge to technical Teacher education in Nigeria. *Nigerian journal of Technology Teacher education*. 3(1), 37-43.
- McClure, R. (2002). *Common data collection strategies effective in Qualitative studies using action research in technical/operational training programs*. Retrieved on February-20-2013 <http://www.evokedevelopment.com/pdfs/common Data.pdf>
- Merriam, S. B. (1998). *Qualitative research and case study application in education*. 2<sup>nd</sup> ed. Sansome street, San Francisco.
- Merriam, S. B. (2009). *Qualitative research: A guide to design and implementation*: 2<sup>nd</sup> ed. Jossey-Bass. A Wiley Imprint.
- Merriam, S. B. (2014). *Qualitative research: A guide to design and implementation*. John Wiley & Sons. *Methods Approaches*. 3<sup>rd</sup> ed. Los Angeles: Sage Publications.
- Miles, M. B., Huberman, A. M., & Saldaña, J. (2013). *Qualitative data analysis: A methods sourcebook*. SAGE Publications, Incorporated.
- Mlambo, W. (2007). *Information and Communication Technology in A-Level Physics Teaching*. Rhodes University: A Master thesis.
- Mudasiru, O. Y. (2007). Trends and Barriers On the integration of Information communication technology in the Nigerian school system. Accepted for publication. Department, of curriculum studies and instructional Technology Olabisi Onabanjo University. Ago Iwoye Nigeria.

- Morse, J. M., Barrett, M., Mayan, M., Olson, K., & Spiers, J. (2008). Verification strategies for establishing reliability and validity in qualitative research. *International journal of qualitative methods*, 1(2), 13-22.
- Muhoza, O. U., Tedre, M., Aghae, N., & Hansson, H. (2014). Viewpoints to ICT Practices and Hindrances from in Tanzanian Secondary Schools and Teacher Training Colleges: Focus on Classroom Teachers. In *Teaching and Learning in Computing and Engineering (LaTiCE), 2014 International Conference on* (pp. 133-140). IEEE.
- Mumtaz, S. 2000. Factors Affecting Teachers' Use of Information and communication Technology: a review of literature. *Journal of Information Technology for Teacher Education*, 3, pp.319-341.
- Murphy, E., & Rodriguez-Manzanares, M. A. (2008). Using activity theory and its principle of contradictions to guide research in educational technology. *Australasian Journal of Educational Technology*, 24(4).
- Muthiah, P., Rahim, R. A., Naidu, R. S., Badzis, M., Nayan, N. F. M., Aziz, N. H. A. (2011). *Qualitative research data collection and data analysis techniques*. University Utara Malaysia Press. Sintok.
- Mwalongo, A. (2011). Teachers' perceptions about ICT for teaching, professional development, administration and personal use. *International Journal of Education and Development using Information and Communication Technology*. 7(3) pp. 36-49.
- Myers, M. D., & Newman, M. (2007). The qualitative interview in IS research: Examining the craft. *Information and organization*, 17(1), 2-26.
- Ndibalema, P. (2014). Teachers' Attitudes towards the Use of Information Communication Technology (ICT) as a Pedagogical Tool in Secondary Schools in Tanzania: The Case of Kondo District. *International Journal of Education and Research*, 2(2), 1-16.
- Ndukwe, E. (2007). *ICT as a tool for achieving the Millennium Development Goal In Nigeria*. Retrieved on July-12-2013 from [[http://www.ncc.gov.ng/speeches\\_presentations/evc's%20presentation/champion\\_lecture\\_2007.pdf](http://www.ncc.gov.ng/speeches_presentations/evc's%20presentation/champion_lecture_2007.pdf)].
- Nouman, M. (2011). *Low-Technology Innovation in a Sectoral System: a Critical Realist Perspective*. University of Southampton: Ph. D. Thesis.
- Ogbondah, L. (2008). An appraisal of instructional materials used to educate Migrant Fishermen's children in Rivers State, Nigeria. *International Journal of scientific Research in Education*, 1(1), 13-25.

- Olelewe, C. J., & Amaka, E. N. (2011). Effective Utilization of Information and Communication Technology (ICT) for Sustainable Manpower Development among Computer Educators in Colleges of Education in South East Geo-Political Zone of Nigeria. *Online Submission*.
- Ololube, N. P., Ubogu, A. E., & Egbezor, D. E. (2007). ICT and distance education programs in a sub-Saharan African country: a theoretical perspective. *Journal of Information Technology Impact*, 7(3), 181-194.
- Onwuegbuzie, A. J., Dickinson, W. B., Leech, N. L., & Zoran, A. G. (2009). A qualitative framework for collecting and analyzing data in focus group research. *International Journal of Qualitative Methods*, 8(3), 1-21.
- Oroma, J. O., Kiden, S., Maghendha, M. W., & Ntiyani, S. (2013, May). Perspectives on underutilisation of ICT in education in Tanzania, Uganda and Kenya. In *IST-Africa Conference and Exhibition (IST-Africa), 2013* (pp. 1-11). IEEE.
- Osakwe, N. R. (2010). The influence of information and communication technology (ICT) on teacher education and professional development in delta state, Nigeria. *Asian Journal of Information Technology*, 9(5), 280-285.
- Oviawe, J. I., & Oshio, L. E. (2011). Impact of Information and Communication Technology on Teaching and Learning Ability of Education Students in Universities in Edo State, Nigeria. *International Review of Social Sciences and Humanities*, 2(1), 126-133.
- Oyenike, A. (2010). Quality Basic Education Development in Nigeria: Imperative for Use of ICT. *Journal of International Cooperation in Education*, 13(2), 193-211
- Palak, D., & Walls, R. T. (2009). Teachers' beliefs and technology practices: A mixed methods approach. *Journal of Research on Technology in Education*, 41(4), 417-441.
- Partnership for 21st Century Learning. (2007). *Framework for 21st century learning*. Retrieved on August-12-2014 from <http://www.21stcenturyskills.org>.
- Patton, M. Q. (2002). *Qualitative Research and Evaluation Methods*. 3<sup>rd</sup> Ed. Thousand Oaks, Ca: Sage.
- Pendergast, D. A., Flanagan, R., Land, R., Bahr, M., Mitchell, J., Weir, K., & Smith, J. (2005). Developing lifelong learners in the middle years of schooling. *Canberra: Ministerial Council on Education, Employment, Training, and Youth Affairs Report*.

- Prensky, M. (2001). Digital natives, digital immigrants part 1. *On the horizon*, 9(5), 1-6.
- Puvenesvary, M., Rahim, R. A., Naidu, R. S., Badzis, M., Nayan, N. F. M., & Aziz, N. H. A. (2008). *Qualitative Research: Data Collection & Data Analysis*. UUM press.
- Rabionet, S. E. (2011). How I Learned to Design and Conduct Semi-Structured Interviews: An Ongoing and Continuous Journey. *Qualitative Report*, 16(2), 563-566.
- Richardson, A. M. (2012). Flexible Skills Development Harnessing appropriate technology to improve the relevance and responsiveness of TVET.
- Robertson, I. (2008). Sustainable e-learning, activity theory and professional development. In *Ascilite* (pp. 819-826).
- Ruthven, K., Hennessy, S., & Deaney, R. (2005). Incorporating Internet resources into classroom practice: pedagogical perspectives and strategies of secondary school subject teachers. *Computers & Education*, 44(1), 1-34.
- Sanchez, J. J. C., & Aleman, E. C. (2011). Teachers' opinion survey on the use of ICT tools to support attendance-based teaching. *Computers & Education*, 56(3), 911-915.
- Sang, G., Tondeur, J., Chai, C. S., & Dong, Y. (2014). Validation and profile of Chinese pre-service teachers' technological pedagogical content knowledge scale. *Asia-Pacific Journal of Teacher Education*, (ahead-of-print), 1-17.
- Saud, M. S., Shu'aibu, B., Yahaya, N., Yasin, M. A. (2011). Effective integration of vocational education and training (TVE) toward knowledge management in the changing world of work. *African Journal of Business Management* 5(16) pp. 6668- 6673.
- Saunders, M. Leunis, P. Thornhill, A. (2007). *Research methodology for Bussiness student and procedure for developing grounded theory*. 2<sup>nd</sup> ed. Thousand Oaks: Sage.
- Scheuermann, F., & Pedro, F. (Eds.). (2010). *Assessing the effects of ICT in education: Indicators, criteria and benchmarks for international comparisons*. Joint Research Centre-European Commission.
- Sethi, M., & Reddy, A. V. (2011). Impact of Teacher Leadership on Students at Post graduate level in Raipur region. *BVIMR Management Edge*, 4(2).
- Shahadat, H. K., Mahbub H., Che K. C. (2012). Barriers to the Introduction of ICT into Education in Developing Countries: The Example of Bangladesh, *International Journal of Instruction* 5(2), 1308-1470



- Shenton, A. K. (2004). Strategies for ensuring trustworthiness in qualitative research projects. *Education for information*, 22(2), 63-75.
- Shulman, L. (1987). Knowledge and teaching: Foundations of the new reform. *Harvard educational review*, 57(1), 1-23.
- Silverman, D. (Ed.). (2010). *Qualitative research*. Sage publication limited.
- Ssewanyana, J., & Busler, M. (2007). Adoption and usage of ICT in developing countries: Case of Ugandan firms. *International Journal of Education and Development using ICT*, 3(3), 49-59.
- Strauss, A. L., & Corbin, J. M. (1990). *Basics of qualitative research* (Vol.15). Newbury Park, CA: Sage.
- Tella, A., Tella, A., Toyobo, O. M., Adika, L. O., & Adeyinka, A. A. (2007). An Assessment of Secondary School Teachers Uses of ICT's: Implications for Further Development of ICT's Use in Nigerian Secondary Schools. *Online Submission*, 6(3).
- Teo, T. (2008). Pre-service teachers' attitudes towards computer use: A Singapore survey. *Australasian Journal of Educational Technology*, 24(4).
- Thomas, T., Alexander, K., Jackson, R., & Abrami, P. C. (2013). The Differential Effects of Interactive versus Didactic Pedagogy Using Computer-Assisted Instruction. *Journal of Educational Computing Research*, 49(4), 403-436. Thousand Oaks, Ca: Sage.
- Tobi, M. S. U., (2013). *Research Methodological Cage, Understanding the Qualitative View point*. Aras publisher Suite 1-4 -21, Diamond Square, Jalan 1/50, off Jalan Gombak.
- Tsebee, K. A., & Akpobo, O. (2015). Influence of global media technology on the social-political and economic environments of national media systems. *Mgbakoigba: Journal of African Studies*, 4(1), 1-11.
- Unesco (2008) *ICT Competency Standards for Teachers: Policy Framework* Retrieved on Jun- 11-2014. From, [Http://Unesdoc.Unesco.Org/Images/0015/001562/156210e.Pdf](http://Unesdoc.Unesco.Org/Images/0015/001562/156210e.Pdf),
- Unesco, (2014) *ICT and Education*, Retrieved on Dec-5-2014. [Http://Www.Unesco.Org/New/En/Unesco/Themes/Icts/](http://Www.Unesco.Org/New/En/Unesco/Themes/Icts/)
- Valentín, A., Mateos, P. M., González-Tablas, M. M., Pérez, L., López, E., & García, I. (2013). Motivation and learning strategies in the use of ICTs among university students. *Computers & Education*, 61, 52-58.

- Vanderlinde, R., & van Braak, J. (2010). The e-capacity of primary schools: Development of a conceptual model and scale construction from a school improvement perspective. *Computers & Education, 55*(2), 541-553.
- Varghese, N. V. (2011). Globalization and cross-border Education: Challenges for the development of higher education in Commonwealth countries.
- Verenikina, I. (2003). Understanding Scaffolding and the ZPD In Educational Research. University of Wollongong, NSW, Australia.
- Verenikina, I. (2008). Scaffolding and learning: Its role in nurturing new learners. *Faculty of Education-Papers, 43*. University of Wollongong, ir ina@uow.edu.au.
- Victoria, L. T. (2011). ICT in Education. *Asia-Pacific Development Information Programme, <http://www.apdip.net>*.
- Vine, R. (2009) *Research paradigms: positivism, interpretivism, critical approach and poststructuralism*. Retrieved on March-26-2015 from <http://rubyvine.blogspot.com/2009/10/research-paradigms-positivism.html>
- Vygotsky, L. S. (1980). *Mind in society: The development of higher psychological processes*. Harvard university press.
- Wakerly, J. F. (2000). *Digital design principle and practice* (Vol. 3). Prentice Hall
- Wang, Q. (2008). A generic model for guiding the integration of ICT into teaching and learning. *Innovations in Education and Teaching International, 45*(4), 411-419.
- Watson, D. (2006). Understanding the relationship between ICT and education means exploring innovation and change. *Education and Information Technologies, 11*(4), 199-216.
- Webb, I. (2007). *Key factors in the use of ICT in primary classroom*. University of Tasmania: PhD Thesis.
- Webb, M., Abbott, C., Blakeley, B., Beauchamp, T., Rhodes, V. (2013) ICT and Pedagogy a Review of the Research Literature, ICT in School Research and Evaluation Series no.18.
- Wiles, R., Crow, G., Heath, S., & Charles, V. (2006). *Anonymity and confidentiality*. ESRC National Centre for Research Methods. University of Southampton.
- Williams, D., Coles, L., Richardson, A., Wilson, K., & Tuson, J. (2000). Integrating information and communications technology in professional practice: an analysis of teachers' needs based on a survey of primary and secondary teachers in Scottish schools. *Journal of Information Technology for Teacher Education, 9*(2), 167-182.

- Wolcott, H. F. (1994). *Transforming qualitative data: Description, analysis, and interpretation*. Sage.
- Woodford, C. (2013) *Electricity and electronic logic gates*. Retrieved on November-15-2015 from <http://www.explainthatstuff.com/logicgates.html>
- Yin, R. K. (1994) *Case study Research: Design and Methods*. 2<sup>nd</sup> ed. Thousand Oaks, Calif: sage.
- Yin, R. K. (2003). *Applications of Case Study Research: Applied Social Research Methods*. 4th ed. Thousand Oaks: Sage Publications.
- Yin, R. K. (2008). *Case Study Research: Design and Methods: Vol. 5*. Sage Publications.
- Yusuf, M. O. (2005). Information and Communication Technology and Education: Analysing the Nigerian National Policy for Information Technology. *International Education Journal*, 6(3), 316-321.
- Yusuf, M. O. (2005b). An investigation into teachers' self-efficacy in implementing computer education in Nigerian secondary schools. *Meridian: A Middle School Computer Technologies Journal*, 8(2), 4.
- Yusuf, M. O. (2006). Problems and Prospects of Open and Distance Education in Nigeria. *Turkish Online Journal of Distance Education*, 7(1), 29.
- Yusuf, M. O., & Yusuf, H. T. (2009). Educational reforms in Nigeria: The potentials of information and communication technology (ICT). *Educational Research and Review*, 4(5), 225-230.