

Aerodynamics of Race Cars

Joseph Katz

Department of Aerospace Engineering, San Diego State University, San Diego, California 92182;
email: jkatz@mail.sdsu.edu

Annu. Rev. Fluid Mech.
2006. 38:27–63

The *Annual Review of
Fluid Mechanics* is online at
fluid.annualreviews.org

doi: 10.1146/annurev.fluid.
38.050304.092016

Copyright © 2006 by
Annual Reviews. All rights
reserved

0066-4189/06/0115-
0027\$20.00

Key Words

downforce, inverted wings, ground effect, drag

Abstract

Race car performance depends on elements such as the engine, tires, suspension, road, aerodynamics, and of course the driver. In recent years, however, vehicle aerodynamics gained increased attention, mainly due to the utilization of the negative lift (downforce) principle, yielding several important performance improvements. This review briefly explains the significance of the aerodynamic downforce and how it improves race car performance. After this short introduction various methods to generate downforce such as inverted wings, diffusers, and vortex generators are discussed. Due to the complex geometry of these vehicles, the aerodynamic interaction between the various body components is significant, resulting in vortex flows and lifting surface shapes unlike traditional airplane wings. Typical design tools such as wind tunnel testing, computational fluid dynamics, and track testing, and their relevance to race car development, are discussed as well. In spite of the tremendous progress of these design tools (due to better instrumentation, communication, and computational power), the fluid dynamic phenomenon is still highly nonlinear, and predicting the effect of a particular modification is not always trouble free. Several examples covering a wide range of vehicle shapes (e.g., from stock cars to open-wheel race cars) are presented to demonstrate this nonlinear nature of the flow field.

INTRODUCTION

Automotive racing must have started at the turn of the twentieth century when the first two automobiles pulled one beside the other. From that first moment on the sport consistently grew, not always following the evolutionary trends of the automotive industry. For example, contemporary race cars have components such as inverted wings and protruding angular plates, which seem unpractical, and are hence unusable by the automotive industry. Those involved with the sport insist that motor racing is a “pure sport” with its own set of rules that need not benefit the general automotive industry. Such opinions paved the way to numerous forms of racing. In some racing categories the vehicles resemble production sedans, and in others they look more like fighter airplanes, not to mention the various tracks that range from paved/unpaved to straight, oval, or regular road courses. In all forms of racing, however, aerodynamics eventually surfaced as a significant design parameter, and by the end of the first 100 years of automobiles, all race car designs have some level of aerodynamic element. Although the foundations of aerodynamics were formulated over the past 200 years, not all principles were immediately utilized for race car design. Naturally, the desire for low drag was recognized first and Hucho (1998, p. 14–15) describes one of the first streamlined race cars (the 1899 Camille Jenatzy) to break the 100 kilometer/hour (km/h) “barrier.” This electric-powered racer had a long cigar shape in an effort to reduce aerodynamic drag. The rapidly developing automotive industry followed and one of the most significant designs of that era is the 1924 Tropfenwagen (“droplet shape” in German) described by Hucho (1998, p. 18–19). This automobile’s shape was dominated by the airfoil shape (particularly from the top view) and recent tests in the Volkswagen wind tunnel showed a drag coefficient of $C_D = 0.28$, which is outstanding even by today’s standards. (Note that in automotive applications the vehicle’s frontal area is used as a reference for the drag and lift coefficients.) Only four years later, in 1929, the Opel-designed rocket race car was the first to employ wings (see vehicle description in Hucho 1998, p. 31–32). Those wings extended sideways, oriented at a negative angle of attack to create downforce. This major innovation was completely ignored and it took another 35 years to fully realize the significance of this principle. Finally, the idea resurfaced in the form of the GMC-supported 1965 Chaparral 2C (Falconer & Nye 1992), which used a variable pitch rear wing to create downforce, changing the shape of race cars from that day on. To explain the significance of aerodynamic downforce on race car performance, the tire characteristics must be discussed briefly first.

The motion of air around a moving vehicle affects all of its components in one form or another. Engine intake and cooling flow, internal ventilation, tire cooling, and overall external flow all fall under the umbrella of vehicle aerodynamics. The present discussion, however, focuses on the effects of external aerodynamics only, and additional information on internal flows can be found in publications such as Hucho (1998, ch. 11–12). As mentioned earlier, the discussion on race car aerodynamics cannot be complete without briefly discussing tire characteristics. Although it is clear that airplanes fly on wings (hence the significance of aerodynamics), the fact that race cars “fly” on their tires is less obvious and requires additional clarification. In fact,

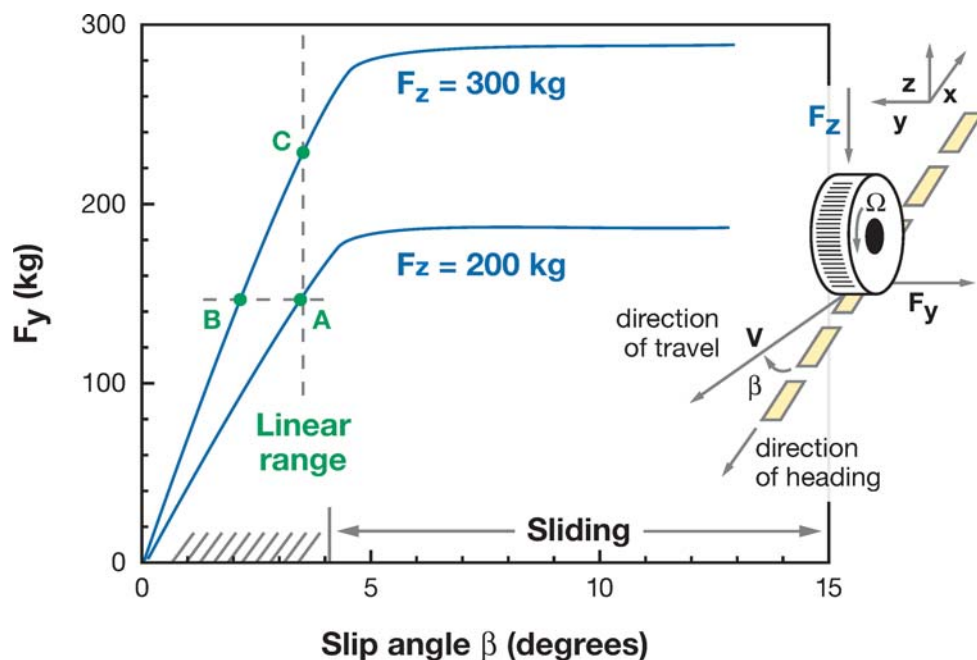

Figure 1

Tire-generated side force versus slip angle, and the effect of normal force. Inset depicts definition of side slip.

aerodynamic forces can be used to improve tire adhesion and, thus, improve vehicle performance. For example, **Figure 1** describes the forces acting on a side-slipping tire on the road. The right-hand side schematics depict the three forces (e.g., F_x , F_y , F_z) acting on the tire in a Cartesian coordinate system aligned with the vehicle, and of course the three moments (M_x , M_y , M_z) must be included as well. In this case the vehicle is heading into the $-x$ direction, but due to a positive side force (could be inertia due to cornering) it slides at an angle β , as shown in the figure. Somewhat similar to the well-known dry friction model, a force is created by the tire, which is proportional to the normal force and initially varies linearly with the slip angle β . So the first observation here is that to generate side force (as in cornering) the tire must be subject to a certain level of side slip. When this slip angle is too large [e.g., over 5 degrees (deg) in this figure] the vehicle is sliding. Some commercial tires generate less side force under such side-sliding conditions, but race car tire manufacturers desire to maintain most of the side force under moderate sliding conditions. So beyond the linear slip range a commercial tire may have a negative slope whereas the racing tire should maintain a flat shape, as shown. In addition, the two curves in the left-hand side diagram depict the effect of increasing the normal load, and, as mentioned, with higher normal force larger lateral forces can be created (hence the analogy to dry friction). Of course a similar diagram may be drawn for the tire longitudinal force (e.g., traction/acceleration

or braking/deceleration) versus longitudinal slip. In this longitudinal case the slip is the ratio between actual road and tire rotation speed. For more information on tires and vehicle dynamics the reader is referred to Milliken & Milliken (1995). The immediate conclusion is that if aerodynamics can be used to increase the normal force acting on the tire, a similar improvement in traction can be expected.

In most forms of racing it is desirable to create the fastest vehicle in a particular category. Traditionally, the effects of external aerodynamics are summarized in terms of drag, lift, and stability. Usually the side force (due to aerodynamic side slip) was not examined carefully because race cars go much faster than the prevailing winds, and, instead of lift, the generation of efficient downforce became the main issue. The three aerodynamic moments came to light when designers realized that vehicle stability (and handling) can be improved by properly balancing the downforce (e.g., front/rear) on the tires. Such desirable aerodynamic downforce can be generated by adding lifting surfaces onto, or by modifying, the vehicle's body. When a vehicle moves fast, lateral instability may become uncomfortable from the driver's point of view. This was observed early with speed record cars that used huge stabilizers (similar to airplane vertical surfaces) in the back (with pure aerodynamic stabilization in mind). An example of this school of thought can be found in vehicles such as the 1970 Blue Flame rocket-propelled car (that passed 1001.7 km/h) shown in Hucho (1998, p. 366), or the 1966 Peugeot CD race car (Hucho 1998, p. 372) that used two large vertical fins on its rear deck. The common design aspect of these two cars is the effort to improve lateral stability by pure aerodynamic means (e.g., by using large rear-mounted rudder-type surfaces). As noted earlier, only toward the end of the 1960s did race car designers realize the huge advantage of using aerodynamics to augment tire traction (and subsequently cornering and stability). To explain this statement we must return to **Figure 1**. Let us assume for the sake of discussion that the vertical load on a tire resulting from the vehicle weight is 200 kilograms (kg). Based on this figure the maximum cornering force that can be created by this tire is somewhat less than 200 kg. Of course, good racing tires can generate larger forces and also the weight transfer (due to vehicle dynamics) is ignored here for simplicity. The above condition can represent a vehicle in a steady cornering maneuver, and tire slip is represented by point A in the figure (and tire full sliding is still a few degrees away). However, with aerodynamic downforce the normal force on the tire can be increased, whereas the vehicle weight is unchanged, resulting in improved performance (e.g., see point B or point C in the **Figure 1**). If the driver decides to turn at the same speed (same side force) then the tire will require less slip (point B) and tire wear and heating will be reduced. On the other hand, the driver can go much faster (e.g., point C) compared to the nonaero-assisted case shown by point A without risking wheel-sliding condition (in **Figure 1** point A and C have the same side-slip value).

This simple fact was not realized until the mid-1960s, and by properly utilizing the aero-assisted tire performance, dramatic improvement can be obtained in cornering, in accelerating out of corners, in braking (at high speed only), and in lateral stability. The handling aspect was particularly important because by controlling the downforce distribution between the front and rear wheels, the vehicle stability could be altered (e.g., by relying on the tires' increased performance rather than on aero

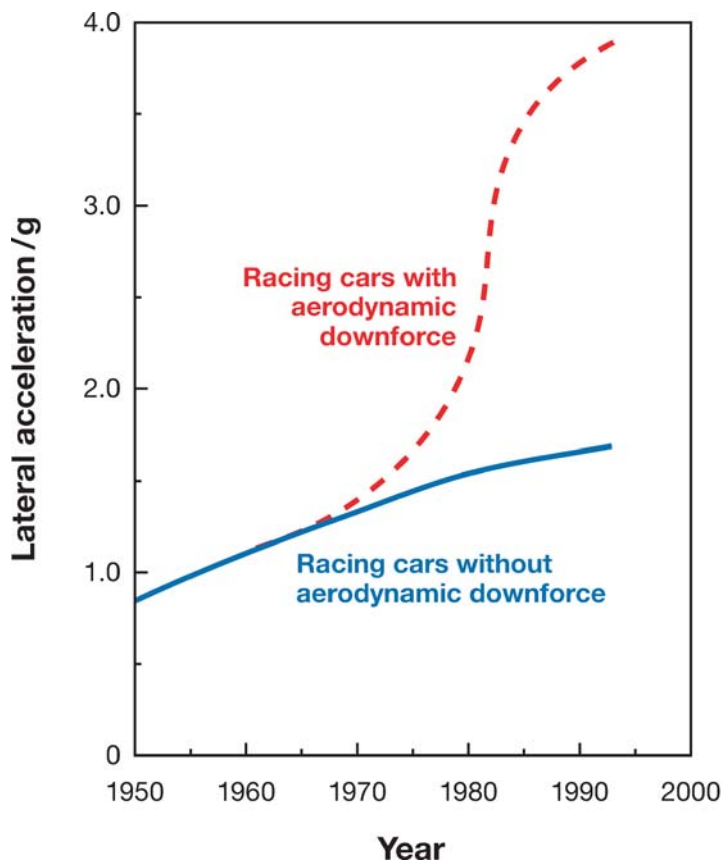

Figure 2
Trends in maximum cornering acceleration, during the past 50 years.

effects of large stabilizing fins). Consequently, the improved cornering due to the use of aerodynamic downforce (Metz 1985, and as explained earlier) led to the dramatic increase in cornering speeds from the 1960s to the mid-1990s, as shown by **Figure 2**. In those years, cornering acceleration grew from less than the gravitational acceleration (g) to close to $4g$ due to the increased use of aerodynamic downforce. **Figure 2** presents the maximum cornering speeds of the more powerful race cars of the era (e.g., open wheels or prototypes). The solid line shows the general trend of improving maximum tire traction (similar to friction coefficient) over the years, whereas the dashed line shows the dramatic increase that occurred once the use of aerodynamic downforce began. One interesting aspect of this phenomenon is that tire traction (with fixed downforce-generating devices) varies with speed. This means that a high-speed braking may start with a $4-g$ deceleration, but the driver should immediately reduce the braking effort because tire adhesion will be reduced gradually, as the vehicle slows down. Also, note that the generation of aerodynamic downforce is accompanied by increased drag, but the ability to corner faster and control vehicle stability clearly contributed to the increased speeds.

Table 1 Typical total downforce and percent of front downforce (%F) requirement for various race track conditions

| | Downforce (lb at 200 mph) | %F |
|----------------|---------------------------|----|
| Road course | 5000 | 45 |
| Short oval | 3500 | 35 |
| Long oval | 2500 | 35 |
| Super speedway | 1500 | 33 |

After this short introduction it becomes evident that the aerodynamic aspects of race car design are not focused on vehicle drag reduction alone. In the case of high-speed road courses, for example, the aerodynamic downforce can increase tire-to-road adhesion without increasing vehicle mass. This improves both cornering and braking and also allows the control of vehicle stability characteristics (handling). This means that the aerodynamic center of pressure must be behind the vehicle center of gravity and the distance or margin is referred to as balance, showing the ratio of downforce between the front and rear tires. Page (2000), in his description of an open-wheel Indy-type racing car, provides the following information (summarized in **Table 1**) on the desirable downforce (at 200 mph) and on the percent of aerodynamic downforce on the front axle (%F), for various race tracks.

Note that because of the highly competitive nature of the motor racing industry, the results of advanced research (often highly sophisticated) are kept confidential and not published in the open literature. Therefore, the ratio of published data to actual research is much smaller than in other engineering disciplines (e.g., aerospace). Also, the goal of such aerodynamic research, in general, is to develop efficient downforce with minimum drag penalty. The principles of drag reduction and vehicle streamlining, focusing on longer laminar boundary layers and less flow separations, are well documented for airplane-type configurations (e.g., see the approach used for airfoils in Liebeck 1973). Therefore, the following discussion focuses mainly on the aerodynamic downforce aspects of race cars.

HOW DOWNFORCE IS CREATED

Race car design was historically always influenced by streamlining the vehicle body, particularly when the focus was on reducing high-speed air resistance. This trend continued well into the middle of the 1960s, implying that aerodynamic vehicles are also aesthetically attractive, an image that was somewhat altered by the discovery of aerodynamic downforce and its effect on race car performance. The foremost and simplest approach to generate downforce was to add inverted wings to the existing race cars. However, this newly discovered advantage was not free of complications. For example, the aerodynamic downforce increases with the square of the vehicle's speed whereas tires depend far less on speed. Consequently, if the inverted wings are attached to the vehicle then the suspension spring rate must be stiffened to allow for the additional high-speed loads. Variable downforce-generating devices followed, mostly based on reducing wing or flap angle of attack at higher speeds. Another

approach was to attach the wings to the unsprung suspension to avoid the stiffening of the suspension springs. These rapid developments within a short period (of less than a year) resulted in several catastrophic failures, followed by regulations completely outlawing movable aerodynamic devices. Some racing organizations ruled out even rotating cooling fans to eliminate any doubt about interpreting the meaning of “no movable aerodynamic device.” But the addition of inverted wings was not the only method to generate downforce. Almost immediately it was realized that the vehicle body may be used to generate downforce as well. The main advantage is the large planview area of the vehicle, and therefore even small values of negative pressure under the vehicle can result in sizeable aerodynamic downforce. The answer to the heading of this section is that aerodynamic downforce can be generated by adding wings or by using the vehicle’s body. Therefore, in the following paragraphs I discuss the principles of using attached wings and the various options for generating downforce with the vehicle body.

Race Car Wings

Airplane wing design matured by the middle of the twentieth century and it was only natural that race car designers borrowed successful airplane wing profiles to use on their vehicles. However, this approach was not entirely successful due to the inherent differences between these two applications. The difficulties in this technology transfer were highlighted by Katz (1994) and his findings can be summarized as follows:

A race car lifting surface design is different from a typical airplane wing design because (a) a race car’s front wings operate within strong ground effect, (b) open-wheel race car rear wings have very small aspect ratio, and (c) there are strong interactions between the wings and other vehicle components (e.g., body, wheels, or other wings). These arguments are discussed in more detail in the following paragraphs.

Ground effect. The increase in the lift of an airplane’s wing when approaching the ground was explained in the early stages of aerodynamic theory (e.g., Pistolesi 1935). The effect is favorable for both lifting and for inverted airfoils creating downforce. Typical results for an inverted airfoil are presented in **Figure 3** (from Zerihan & Zhang 2000). The data clearly show the trend and the significant magnitude of the effect, particularly when the ground clearance is smaller than the airfoil quarter chord. The effect does not come freely and a similar increase in drag was measured by Zerihan & Zhang (2000). Because many race cars use front wings, typically mounted as close as h/c of 0.1–0.3, this principle is clearly utilized in race car design (in **Figure 3**, h = ground clearance and c = airfoil chord). In a later work, Zhang & Zerihan (2003) demonstrate the same obvious behavior for a wing with a two-element airfoil.

Because of the large magnitude of this effect, numerous studies focused on this subject and Coulliette & Plotkin (1996) recently summarized the two-dimensional effects. In their work they separated the contributions of parameters such as thickness, camber, and angle of attack to the airfoil’s lift. From the race car point of view the interesting observation is that for an inverted airfoil (e.g., creating downforce) all of the above effects will increase the downforce near the ground. This includes the

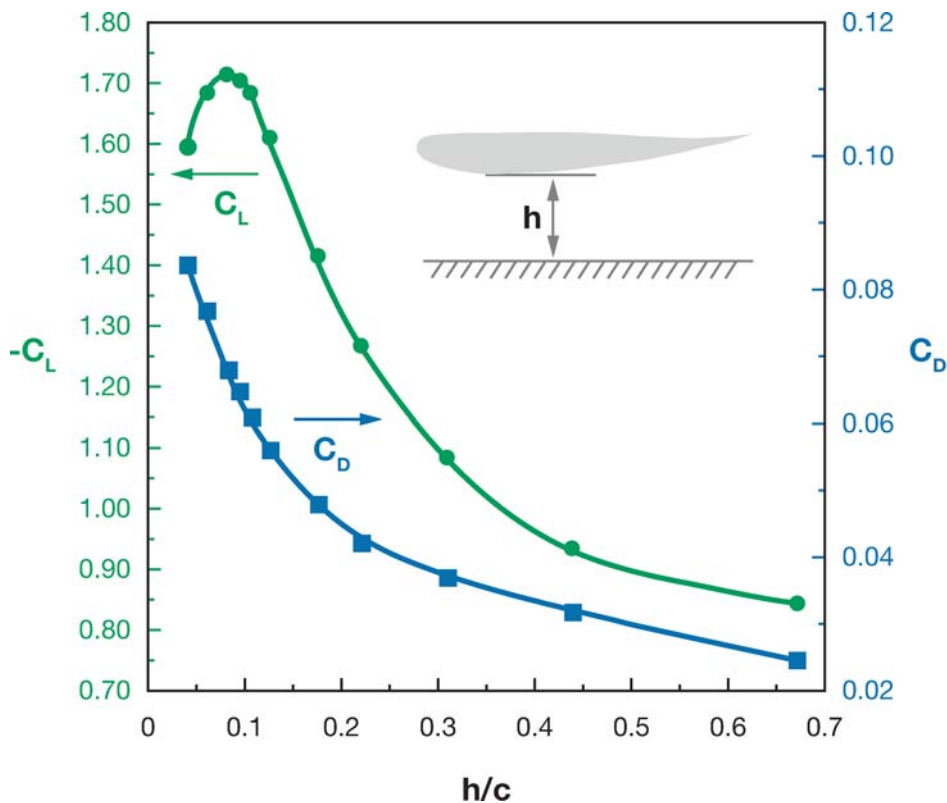

Figure 3

Downforce and drag coefficient versus ground clearance for an inverted LS(1)-0413 airfoil. [From Zerihan & Zhang (2000), $\alpha = -1$ deg, $Re = 2 \times 10^6$, moving ground plane.]

positive effect of angle of attack and camber, which in the case of an airplane wing (lifting) near the ground are negative.

Three-dimensional ground effect calculations for finite-span rectangular wings were reported by Katz 1985b, who showed that the effect remains large even in the case of an $AR = 2$ rectangular wing (which is less than most race car front wings). The focus of this study was on estimating the unsteady loads on such wings due to oscillatory heaving motions (due to suspension travel); this information was vital in those early days of using lifting surfaces on race cars. Because of the very close proximity to the ground, the type of boundary condition on the ground strongly affects both numerical and experimental results. Wiedemann (1989) discusses some of these effects and concludes that moving ground simulation is essential for such cases. He shows several types of boundary layers on the ground and Berndtsson et al. (1988) provide information on the floor boundary-layer flow, with or without rolling ground simulation.

Small aspect ratio wings. In most forms of motor racing a large rear wing is used. In the case of open-wheel race cars such as Indy cars these wings have aspect ratios (ARs) approaching one. Recent trends, aimed at reducing the cornering speeds of the cars, also limit rear wing size, but the AR is still close to two. Initial designs were based on using existing high-lift airfoil shapes (e.g., from airliners) and some of the airfoils used in the late 1980s were tested by Katz & Dykstra (1989). Typical two-dimensional pressure distribution on a high-AR airplane wing section is presented in the upper part of **Figure 4** (from Katz 1989). However, when wing AR was reduced (e.g., for the rear wing of an Indy car), the pressure distribution changed dramatically, as shown in the lower part of the figure. This change in the pressure distribution is mainly due to the traditional finite wing effect (see Prandtl's lifting line in Glauert 1926, ch. 11) and can be calculated by potential flow methods. The immediate conclusion is that such wings can be pitched more (than the high-AR ones) to increase the leading-edge suction, and **Figure 5** shows the results of such an experiment. The data in this figure show no stall and the lift slope is linear through a wide range of angles of attack. In reality, of course, there is local trailing edge separation, but the two strong (trailing) side vortices attach most of the flow on the suction side. The effect of removing the side fins (or end plates), as expected, results in loss of lift, but the no stall characteristics remain. Hoerner (1985, p. 3.9) addresses this positive effect of the side fins on lift, whereas the drag increment is much smaller, suggesting a large improvement in lift-to-drag ratio (L/D) due to the end plates.

Wing/vehicle interactions. The third major difference between aircraft and race car wings is the strong interaction between the lifting surface and the other body components. In a 0.25% scale wind tunnel test, Katz & Largman (1989b) experimented with a generic prototype race car (enclosed-wheel type) by measuring integral forces and surface pressures with and without the rear wing. The data clearly indicates that the closely coupled configuration downforce is much larger than the combined (but far apart) contribution of the body and the wing alone. **Figure 6** (from Katz & Dykstra 1992) demonstrates the rear-wing interaction for two different race cars. The data in the upper diagram is for a sedan-based race car whereas the data at the bottom is for a prototype race car with large underbody diffusers (a "rear diffuser" is the upward slant of the vehicle's aft-lower surface; see **Figures 11–13**). In both cases the wing height is varied up to a condition where the interaction is minimum. The combined downforce increases as the wing approaches the vehicle's rear deck. At a very close proximity the flow separates between the rear deck and the wing and the downforce is reduced. The horizontal positioning (e.g., fore/aft) of the wing also has a strong effect on the vehicle aerodynamics (usually downforce increases as the wing is shifted backward), but racing regulation stated that the wing trailing edge cannot extend behind the vehicle body (in top view). The very large change in the downforce of the prototype car (at the bottom of **Figure 6**) is due to the increased underbody diffuser flow, but the effect remains clear with the sedan-based vehicle (with the much smaller wing) as well. Note that these results are based on fixed-floor wind tunnel testing. Later tests with rolling ground apparatus showed that the effect remains, although its magnitude will increase.

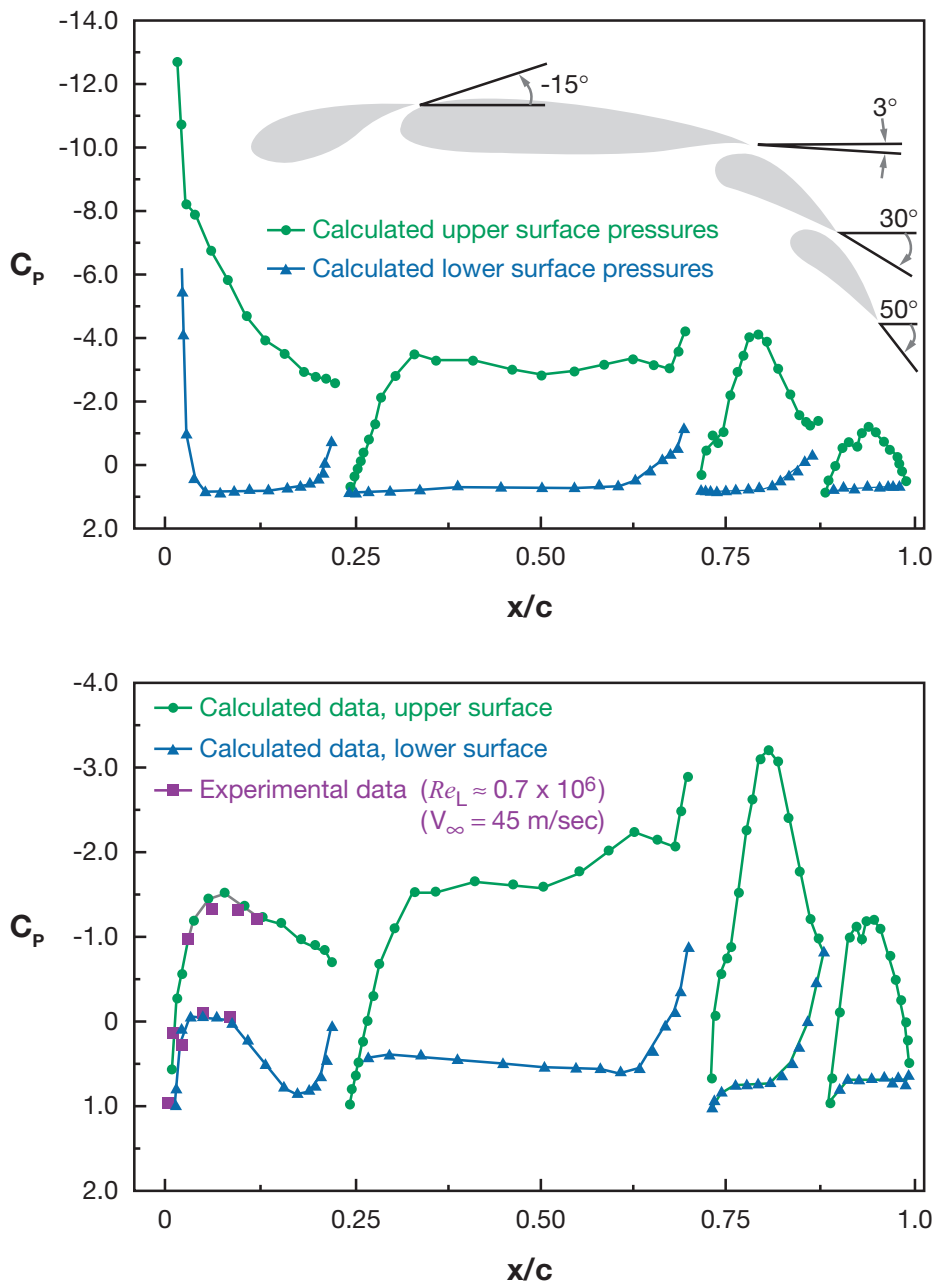

Figure 4

Chordwise pressure distribution on a two-dimensional four-element airfoil (*top*), and at the centerline of an AR = 1.5 rectangular wing (*bottom*), having the same airfoil section. AR, aspect ratio. [From Katz (1989). Reprinted by permission of the American Institute of Aeronautics and Astronautics, Inc.]

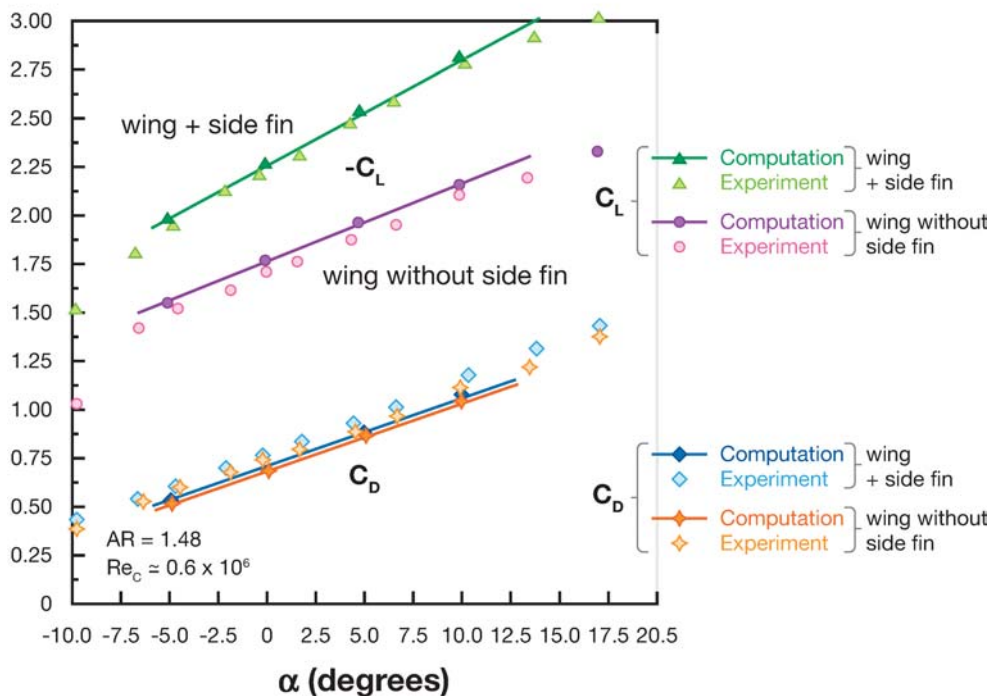
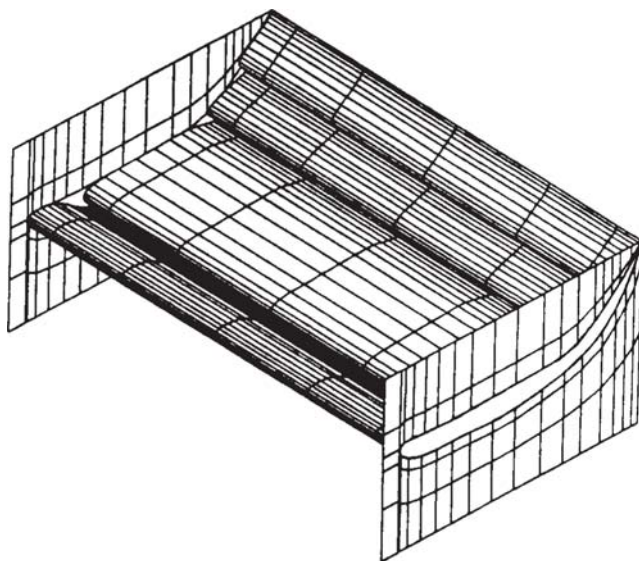
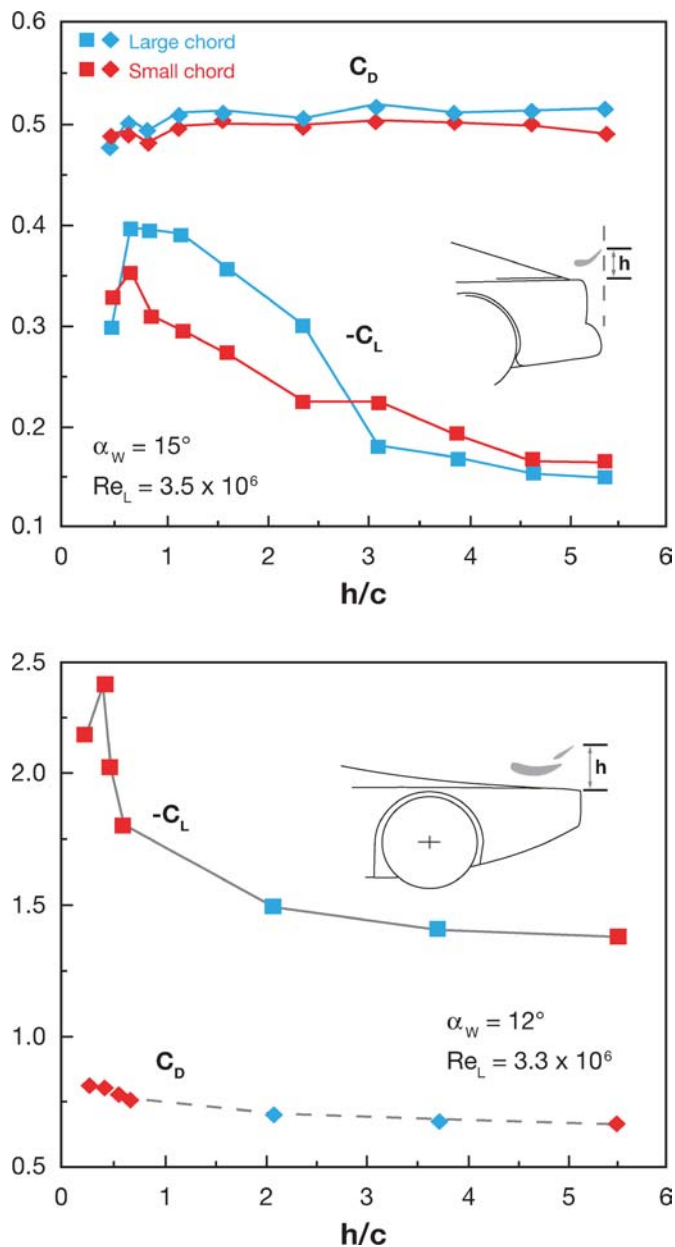

Figure 5

Lift and drag coefficients for the rear wing of a generic open-wheel race car. $AR = 1.5$, and coefficients are based on planview area. AR , aspect ratio. [Reprinted with permission from Katz & Dykstra (1989), SAE Paper 89,0600 © 1989 SAE International.]

Figure 6

Effect of wing vertical position on vehicle's total lift and drag coefficients. The upper figure is for a sedan-based vehicle and the lower one is for a prototype race car. [Reprinted with permission from Katz & Dykstra (1994), SAE Paper 92-0349 © 1992 SAE International.]



The trend shown in **Figure 6** remains for open-wheel race cars as well because of the induced low pressure at the rear diffuser exits (e.g., increasing the flow under the car). Such race cars (e.g., Indy cars) also have a large front wing, and the main advantage of the dual wing configuration (which is not allowed in all forms of racing) is that the vehicle center of pressure (balance) is easily controlled (by pitching the

front wing or its flap). Although these types of wings are exposed to the undisturbed freestream, their interaction with the vehicle is not always linear. Katz & Garcia (2002) reported one of the more complicated front wing/vehicle interactions. This wind tunnel study, with moving and stopped ground plane, focused on open-wheel (Indy-type) race cars, and the generic shape of the front wing with flaps is shown in the upper inset to **Figure 7**. Most open-wheel racing regulations allow a wing span wider than

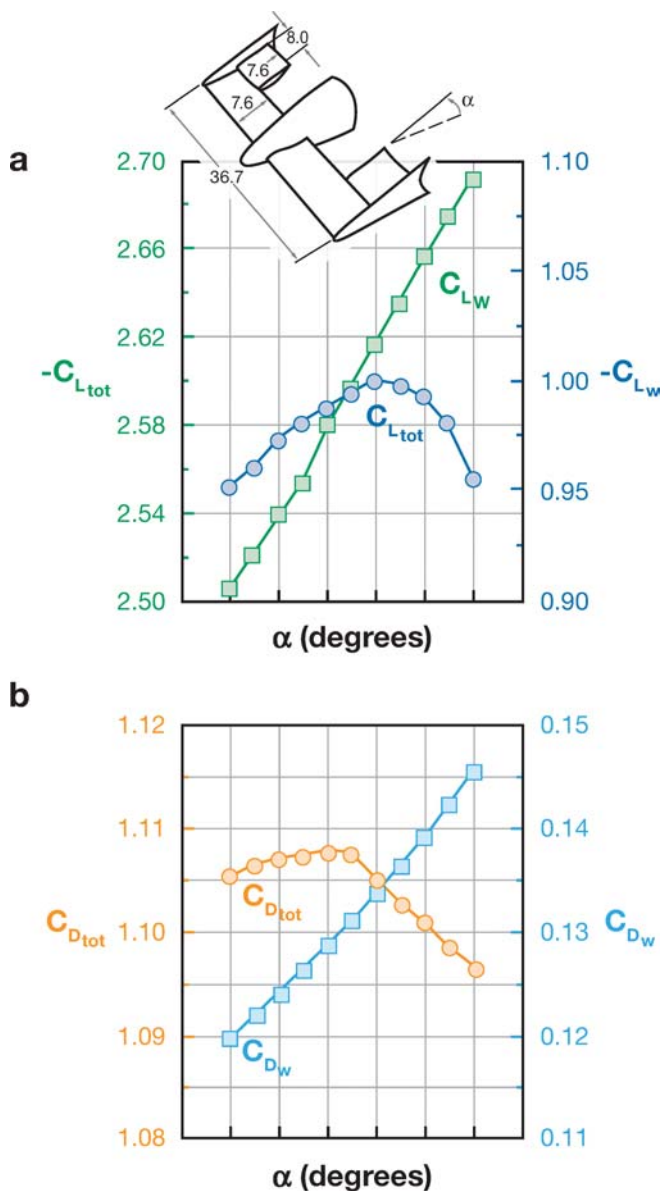

Figure 7
Lift and drag coefficient variation with front wing flap angle. Circular symbols represent vehicle total loads and square symbols represent loads on the front wing only. [Reprinted with permission from Katz & Garcia (2002), SAE Paper 2002-01-3311 © 2002 SAE International.]

the distance between the two front wheels. However, earlier (unpublished) studies show an unfavorable interaction between the wing-tip vortices and the wheels, clearly favoring the narrower wing-span design. In this experiment the wing geometry was fixed and only the flap angle was changed. Also, the front wing loads were measured by an additional balance to isolate it from the total vehicle loads. The downforce results are presented in **Figure 7a**, where C_{L_w} stands for the front wing downforce and $C_{L_{tot}}$ is the total vehicle downforce. As expected, the lift of the wing increases almost linearly with the change in the flap angle, while the vehicle's total lift increment is much smaller and seems to stall at a certain point. Flow visualizations indicate that the tip vortex of the front wing eventually reaches the rear wing, and at high flap angles, the rear wing lift is reduced as well (so downforce is not increasing, but the center of pressure does move forward). Additional tests with this model show that by increasing the angle of attack of the front wing main element by a few degrees the underbody flow is diverted, resulting in loss of underbody downforce. This means that the optimum spanwise loading of such a front wing has a much larger loading near the tips—the complete opposite of the ideal elliptic (airplane-type) loading.

Similar trends (to the downforce data) are exhibited by the drag data in **Figure 7b**. Here again the drag polar of the wing alone (C_{D_w}) should grow with increased flap angle, as shown by the square symbols. However, the complete vehicle drag ($C_{D_{tot}}$) after reaching a maximum is reduced in spite of the expected drag increase of the wing. This could be explained by the loss of total downforce due to the interaction with the flow under the car and with the rear wing.

Gurney flaps. Initially, race car wings were based on airplane airfoil shapes, and their design was based on aerospace experience. However, a small trailing edge flap defying aerodynamic logic momentarily reversed this order because it was used on race cars prior to the transfer of this technology to aerospace applications. At the very early stages of using wings on race cars (in the late 1970s), a thick Newman airfoil was added to an Indy car (Liebeck 1978). Because of the high speed and structural considerations, a small vertical reinforcement was added on top of the airfoil, at the trailing edge, spanning the whole width. After adding this structural reinforcement, and to the surprise of the aerodynamicist, the car lapped at a higher speed, indicating a lower drag. This is how the Gurney flap began its dominance in race car wing design (Gurney was the name of the driver of that car). In this first study the surprising drag reduction was reported along with the increase in the vehicle's downforce. The effect of such vertical trailing edge flaps on isolated and highly cambered wings was reported later by Katz & Largman (1989a). They demonstrated that the gain is a result of trailing edge boundary-layer reattachment, but also noted a change in the direction of the trailing edge flow (indicating larger circulation). Water tunnel flow visualizations showing such trailing edge flows were reported by Neuhart & Pendergraft (1988), documenting the change in shape of trailing edge separation with the flap height. Ross et al. (1995) extensively studied such flaps placed in several strategic locations in a two-element wing. Even when placing the tabs in the gap between the two elements of the airfoils or at a position forward of the flap trailing edge, they found significant

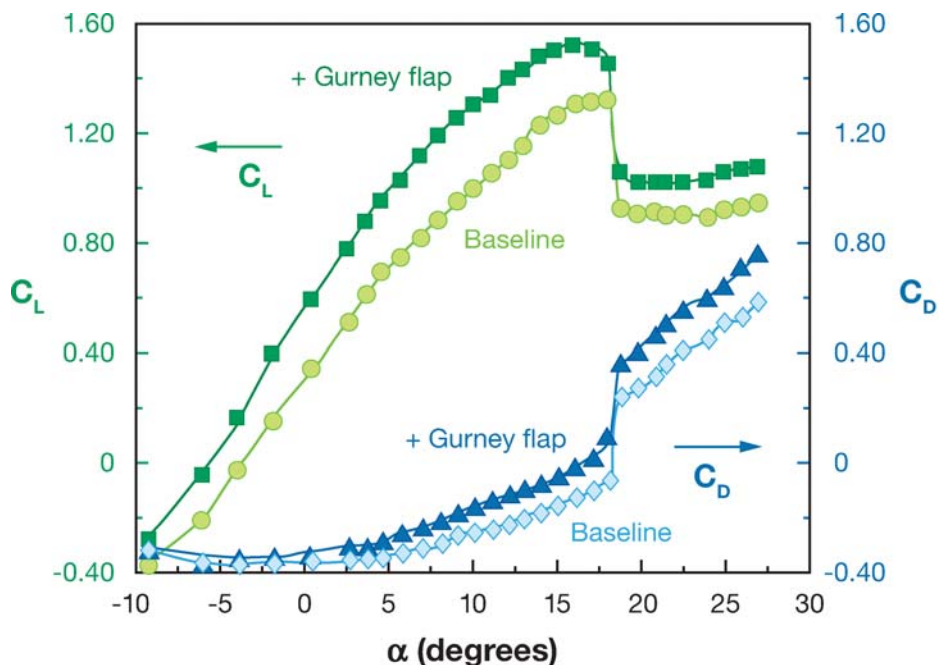

Figure 8

Effect of adding a 1.7% chord-long Gurney flap on the lift and drag coefficient of a rectangular wing ($AR = 8$, NLF 0414 airfoil). AR , aspect ratio. (Data from Myose et al. 1996.)

levels of gains in the lift. Carrannanto et al. (1994) followed with numerical analyses of Gurney flaps to validate these results, to calculate streamline shapes near the trailing edge, and to compare them with the water tunnel flow visualizations of Neuhart & Pendergraft (1988). Numerous other studies followed, such as Papadakis et al. (1997), revisiting the effect of a tab both at the trailing edge and inside the gap between the airfoil's two elements. Three-dimensional effects, demonstrating the effectiveness of these tabs for practical airplane wings, were reported by Myose et al. (1996). Typical lift and drag data on the effect of such a short flap are shown in **Figure 8**. In this case, Myose et al. (1996) used a rectangular wing with $AR=8$, a NLF0414 airfoil, and a 1.7% chord high Gurney flap. In general, the lift increases with the addition of the flap, as well as the drag, throughout the whole range of angles of attack. The case of drag reduction, as reported by Liebeck (1978), is present only with very thick airfoils and not present with modern low drag airfoil shapes (as in **Figure 8**). Also, an increase in flap size (sometimes up to 5%) will show lift increase and occasional improvements in L/D .

The applicability of the device to race cars' front wings was revisited by Zerihan & Zhang (2001), who investigated the effect of ground proximity, and Jeffrey et al. (2001), who extended this work to two-element airfoils. Because of the simplicity and effectiveness of this device it is used in almost all forms of motor racing.

Creating Downforce with the Vehicle's Body

Once the potential of using aerodynamic downforce to win races was realized, designers began experimenting with methods other than simply attaching inverted wings. It was immediately clear that with the larger planform area of the body (compared to an add-on wing), significant levels of downforce could be generated. The basic effect is similar to Pistoletti's (1935) early wing in ground effect model. However, the nature of the flow under the vehicle must be considered, and **Figure 9** (from Katz 1995, p. 49) depicts this for two generic bodies. At the upper part of the figure, a symmetric ellipsoid is approaching the ground. The flow accelerates under the ellipsoid and a downforce, increasing with reduced proximity, is created. However, if the same area distribution (along the length) is distributed in a semi-ellipse shape, as shown, the opposite (e.g., lift) is measured due to the reduced flow under the body. Furthermore, potential flow solutions of the flow over a hemisphere show a lift coefficient of $11/8$ due to the pressures on the upper surface. So, clearly, the shape on the lower figure (which resembles automotive shapes) will have lift that will increase with reduced ground clearance. The conclusions are simple: One option is to streamline the underbody to generate lower pressures there (as a result of higher speed), and another option is to create low pressure under the car by effects not directly related to the basic wing in ground effect model. Another method to generate this effect is to seal the gap between the ground and the car entirely, leaving only the rear portion open. Then the low base pressure behind the vehicle dictates the pressure under the car. Early race car designs used flexible "skirts" around the car and a large rear spoiler or wing to create the low base pressure behind the vehicle. In this case, lowering the rear deck reduces the base area and the drag component (due to the base pressure), improving the downforce to drag ratio. Recent regulations, however, eliminate such flexible seals around the vehicle, but current NASCAR design aimed at reducing the flow under the car may have evolved from such an aerodynamic design concept. Although such methods were experimented with in the past, no published data was found on this concept.

The next logical development focused on actively controlling the low pressure under the car independently of vehicle's speed. This school created the so-called suction cars. The first was the 1969 Chaparral 2J described by Falconer & Nye (1992, ch. 7) or Katz (1995, p. 247). This car used auxiliary engines to drive two large suction fans behind the vehicle. The whole periphery around the car underbody and the ground was sealed and the fans were used to suck the leaking air through the seals to maintain the controllable low pressure. Another benefit from this design was that the ejected underbody flow (backward) reduced the base pressure and therefore the vehicle's drag penalty was not high. In terms of performance, the downforce was controlled by the auxiliary motors and did not increase with the square of speed, making the car quite comfortable (no stiff suspension) and competitive. Needless to say, the design was winning from day one, which was not well received by the competition (e.g., regulation almost immediately outlawed such designs). This concept was repeated years later in Formula 1 with the 1978 Brabham BT46B (see Katz 1995, p. 248). History repeated itself and the car won directly out of the box and was outlawed by the next race. Again, no engineering data was found on these vehicles.

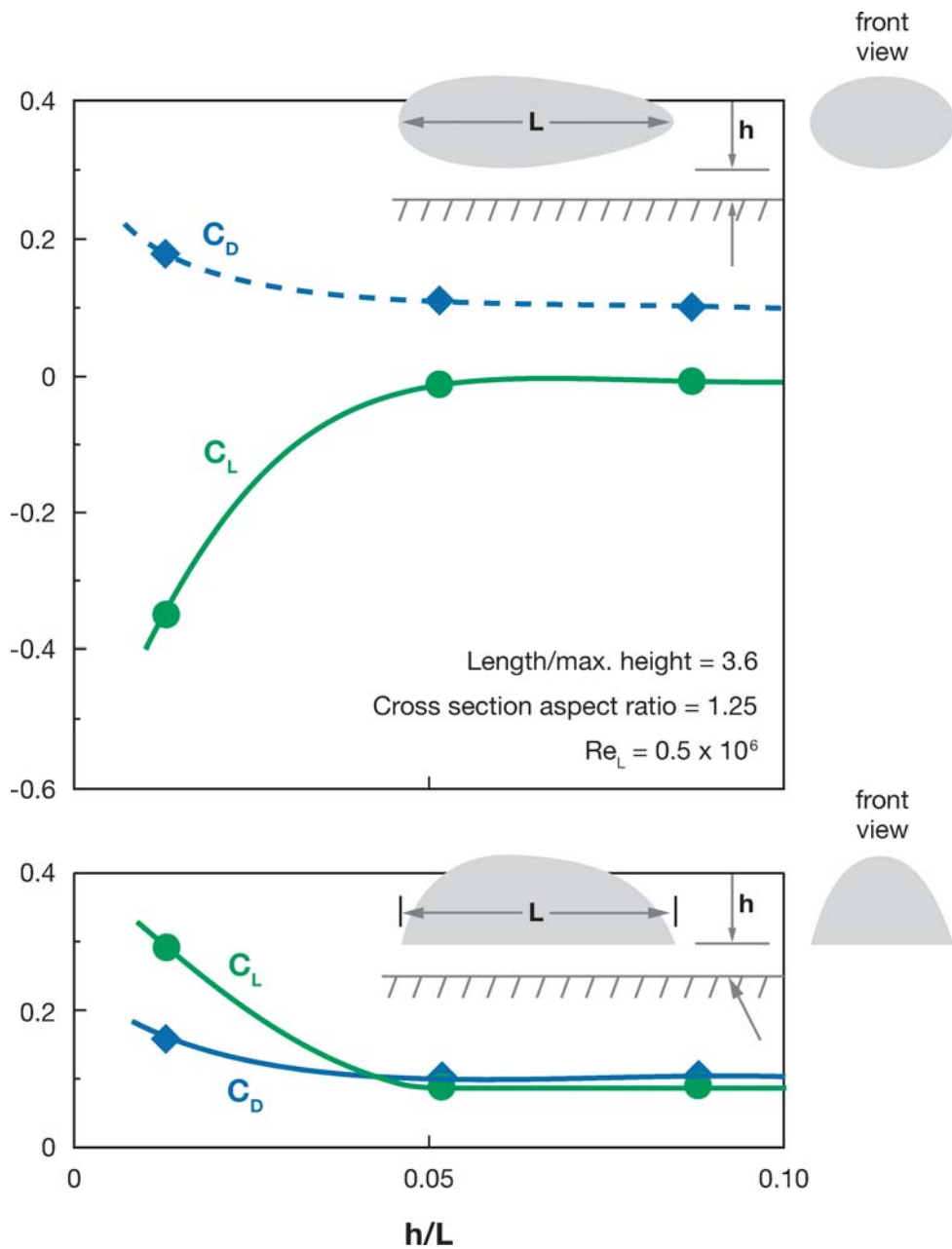

Figure 9

Effect of ground proximity on the lift and drag of two generic ellipsoids (width/height = 1.25, length/height = 3.6, max. thickness at 1/3 length). (From Katz 1995.)

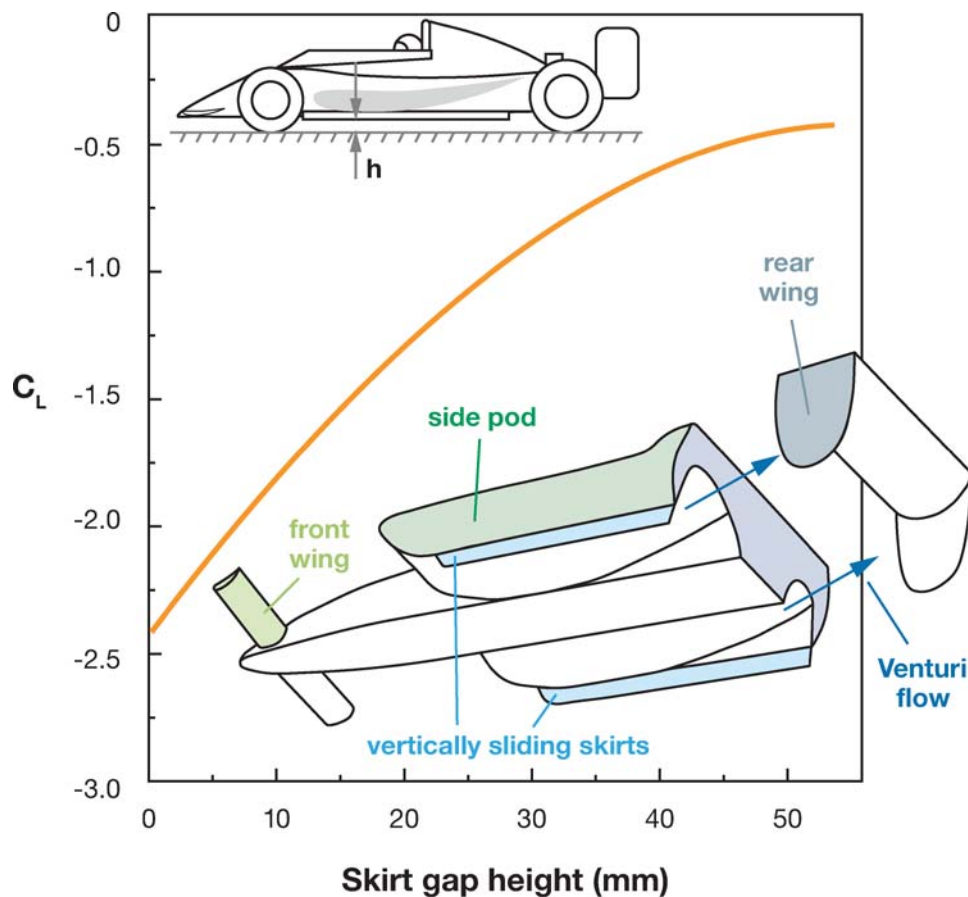

Figure 10

Effect of side skirt to ground gap clearance on vehicle's total downforce coefficient. (From Wright 1983.) (Note that the underbody diffuser is called "venturi" in this sketch.)

Because the suction car concept was banned by the sanctioning bodies, the only other alternative was to use the old fashioned ground effect to create downforce by the vehicle's body. Colin Chapman, designer of the famous Lotus 78 (Hofer 1978), developed this concept to fit F 1 race car geometry. In his design the vehicle's side pods had an inverted airfoil shape (in ground effect) and the two sides of the car were sealed by sliding 'skirts'. These side seals created a two-dimensional environment for the small AR inverted wing-shaped side pods. The concept (as shown by the inset to **Figure 10**) worked very well, resulting in large suction forces under the car, as reported by Poncini & Di Giusto (1983). A year after the first application of this principle, Hofer (1978) documented Chapman's approach for integrating the inverted airfoil idea into the vehicle side pods using the sliding skirts. Needless to say, the concept was highly successful and the Lotus 78 won the world championship

in 1977. By the end of the 1980s this method was used in many forms of racing, resulting in downforce values exceeding the weight of the vehicle (Wright 1983). However, the sliding seals at the vehicle sides were not trouble free. Irregularities in the road surface occasionally resulted in seal failure and the immediate loss of downforce with catastrophic consequences. The effect of increasing the gap between the ground and the seal on the downforce is shown in **Figure 10** (from Wright 1983), and a 20-millimeter (mm) gap could result in the loss of 50% downforce. This led to the banning of all sliding seals by 1983, and in most forms of racing the only part of the vehicle allowed to be in contact with the ground are the tires.

Once the sliding skirts concept was banned it was realized that an inverted airfoil-shaped underbody can still generate downforce (see Poncini & Di Giusto 1983). Because the only area that this approach could fit in (under the car) was between the wheels, the so-called diffusers, or tunnels, were created. Based on the data presented by Poncini & Di Giusto (1983), these diffusers could be viewed as the logical evolution of the now-banned “skirted, inverted airfoil-shaped side pods” concept.

Diffusers. Basic incompressible flow theory indicates that even a nonlifting body in ground proximity can develop downforce (e.g., see the upper part of **Figure 9**). This approach was initially ignored by race car designers and, as mentioned, the inverted wing-shaped side pods were the first effort to generate downforce with the vehicle’s body. Only after banning the sliding seals was this basic idea reintroduced. Even then the concept was an evolution of the tunnels formed under the side pods, which are now called diffusers. One of the first basic studies investigating such diffuser flows, although lagging a few years behind the actual use of such diffusers on race cars, was conducted by George (1981) and George & Donis (1983). They used a simple generic shape with an underbody diffuser, as shown in the inset in **Figure 11**. This work demonstrated that high levels of downforce can be generated without permanent seals sliding on the ground. The downforce will increase with reduced clearance, an effect that will peak (diffuser stall) when ground clearance (h) drops slightly below h/L ($L =$ vehicle’s length) 0.05. This type of flow was also of interest to the automotive industry and several investigations followed. A comprehensive study of such a generic model with a wide range of rear diffuser shapes was conducted about 15 years later by Cooper et al. (1998), with passenger vehicles in mind. A typical set of their data is presented in **Figure 11**, showing the variation of downforce and drag with the ground clearance. The effect of rolling ground increased the measured downforce, but the basic characteristics were unchanged. When varying diffuser angles they found that for larger diffuser angles, the onset of diffuser stall occurs earlier. For example, in the data of **Figure 11** the diffuser angle is 10 deg and stall appears at $h/L \sim 0.02$, but for a diffuser angle of 15 deg this occurs at $h/L \sim 0.22$! Cooper et al. (1998) also measured the pressures along the lower surface of the body, showing the suction peaks near the tunnel entrance. The significance of this pressure peak for race car application is that by the fore/aft shifting of the diffuser entrance, the location of the vehicle center of pressure can be controlled. It is interesting to note that the lift coefficient values reported by Cooper et al. (1998) are less than those reported by George & Donis (1983) due to the slightly different dimensions of the generic model (e.g., smaller diffuser).

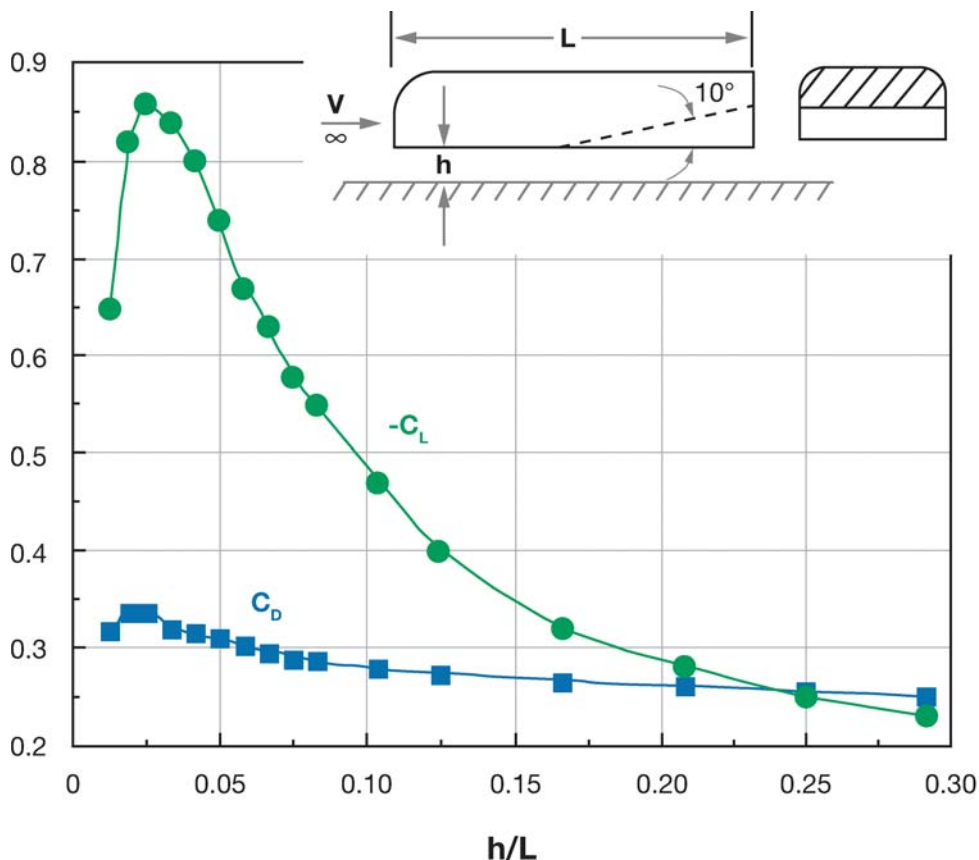

Figure 11

Lift and drag coefficient variation with ground clearance for a generic model with underbody diffuser. [From Cooper et al. (1998). $Re_L = 0.83 \times 10^6$, rolling ground.]

In a more recent work, Senior & Zhang (2001) tried to generate additional information on the basic fluid dynamics of the diffuser flow. While testing a variety of diffuser angles, they identified two vortices forming at the side edges of the diffuser and concluded that the Reynolds number effects are not significant. It appears that the underbody flow tends to separate at the sharp diffuser entrance only to be reattached by the two side vortices. Because the separation line is dictated by the sharp diffuser angle, the Reynolds number effect was small. The same study was carried further by Ruhrmann & Zhang (2003), who tested diffuser angles within a wider range of 5 to 20 deg, with moving ground. Their focus was on understanding the diffuser stall and extensive surface oil-streak flow visualizations were conducted. They demonstrated that the loss of downforce at low ground clearance was a result of combined vortex breakdown and flow separation, and classified various scenarios for the different diffuser angles. For the lower diffuser angles, vortex breakdown is the primary cause of

force reduction, whereas at the higher diffuser angles a combination of flow separation and vortex breakdown is observed. Again, the lift coefficient values reported in this work are about twice those in **Figure 11** due to slightly different geometry.

The integration of this concept into an actual race car underbody is depicted in the upper part of **Figure 12**. Flow visualizations (from Katz & Largman 1989b) clearly show the existence of the side vortices responsible for reattaching the flow in the tunnels (diffusers). Surface pressures measured along the tunnel centerlines are shown in **Figure 12** and the sharp suction peak at the tunnel entrance is evident. In this study several diffuser angles were used and the resulting downforce and drag coefficient for the complete vehicle are shown in the table inserted in the figure. For this particular geometry, diffuser angles larger than 14 deg stalled and created less downforce.

Add-ons: vortex generators, spoilers, etc. In this section we discuss simple modifications that can be added to an existing car to increase downforce. One of the simplest add-ons is the vortex generator (VG). VGs were used for many years on aircraft, mainly to control boundary-layer flows. The size of VGs in such applications was on the order of the local boundary-layer thickness, and apart from influencing boundary-layer transition, they served to delay the flow separation on a wing's suction side. The use of such devices in automotive racing is quite different. Here the focus is on creating a stable and long-tip vortex, which in turn can reduce the pressure along its trail. A simple option is to add VGs at the front of the underbody and the long vortex trails of the VGs can induce low pressure under the vehicle. This principle is widely used for open-wheel race cars (e.g., Indy), and a typical integration of such VGs into the vehicle underbody is shown in **Figure 13**. In such an application the VG is much taller than the local boundary-layer thickness and the objective is to create a strong and stable vortex which, as noted, can generate suction loads along its trail. The principle was extensively used with delta winged aircraft at high angle of attack (Polhamus 1971), but when the wing surface was not at high angle of attack, the interest was mostly diminished (see, for example, Buchholz & Tso 2000). A generic study of these VGs mounted to flat plates was reported by Garcia & Katz (2003), and the results of a similar study, but with the actual shape of the race car underbody (as in **Figure 13**), was reported earlier by Katz & Garcia (2002). The combined downforce and drag results for the two underbody shapes is presented in **Figure 14**. Note that in the case of a flat plate the VGs were placed below the plate and ground clearance was measured from the lowest point of the VG to the ground. In the Indy-type underbody case the VGs were flush with the immediately following body's lower surface and ground clearance was measured from the vehicle's or the VG's lower surface. Also, for the data in **Figure 14** the VGs were oriented at 20-deg yaw, and results for additional shapes and yaw angles are presented by Katz & Garcia (2002).

The downforce data in **Figure 14**, in general, increases as the ground clearance is reduced. The basic flat plate will have the lowest drag and no downforce. The curved Indy car underbody, but without the VGs, does generate downforce, even far from the ground, because of its effective thickness and camber. As ground proximity is reduced, downforce increases for this configuration, along with the associated drag as shown in **Figure 14**. When two VGs per side were added to both models, the

Figure 12

Effect of underbody diffuser angle on diffuser centerline pressure distribution. (From Katz & Largman 1989b.)

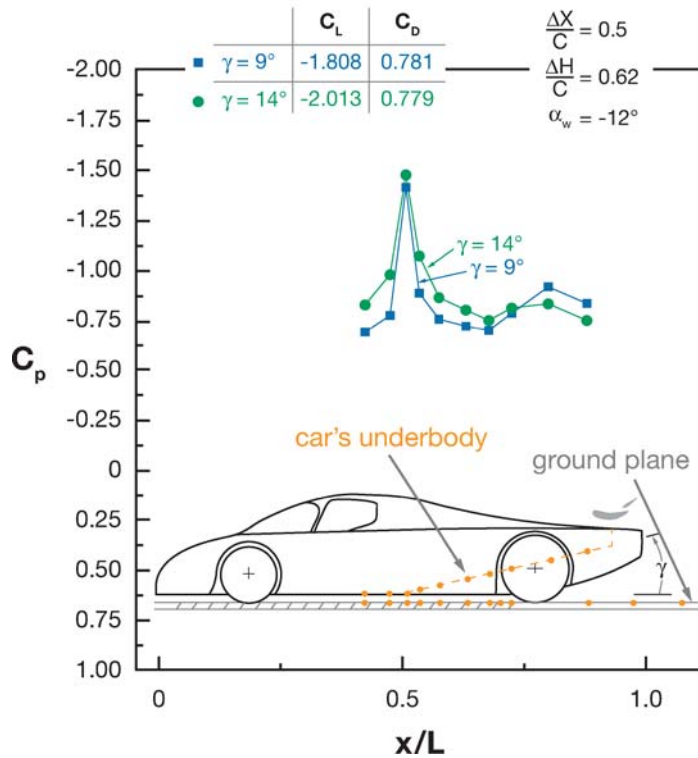
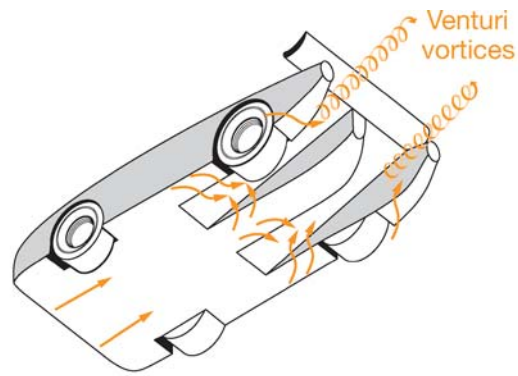

downforce and drag increments were similar and large. Flow visualizations with these models indicate that with reduced ground clearance not only does vortex strength seem to increase but the two vortices per side untangle and get closer to the vehicle's surface (e.g., increasing suction force). This increase in vortex strength and the reduced distance from the underbody (of the vortex) explain the increase in both lift and drag as ground clearance is reduced. At the very low ground clearance values,

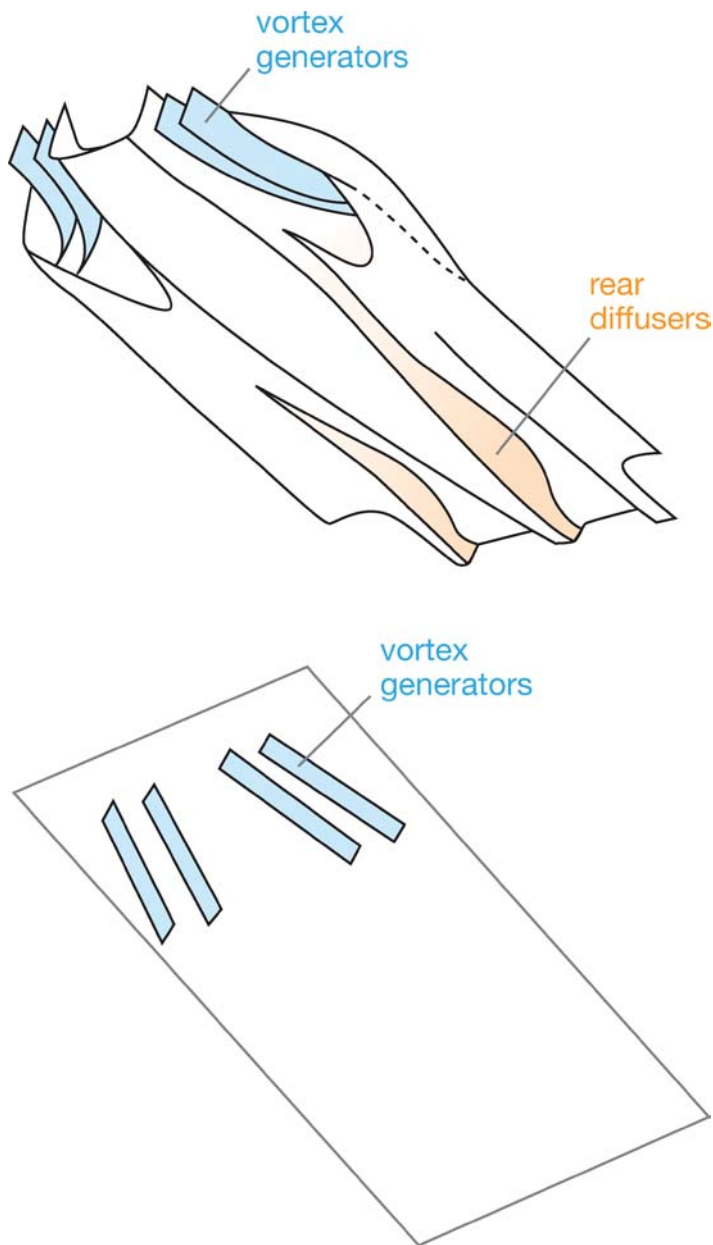

Figure 13

Schematic description of a circa year 2000 Indy car underbody and a simple flat-plate model with vortex generators (VGs). Note the two per-side VGs at the front.

however, a maximum in the downforce is reached due to possible breakdown effects in the trailing vortices.

The discussion on vehicle body-related downforce cannot be complete without mentioning some of the widely used add-ons such as spoilers, dive plates, etc. One of the earliest type of spoilers is usually mounted on the rear deck of sedan-type vehicles

Figure 14

Downforce and drag coefficient variation with ground clearance for the generic Indy car underbody, with and without vortex generators. [Reprinted with permission from Katz & Garcia (2002), SAE Paper 2002-01-3311 © 2002 SAE International.]

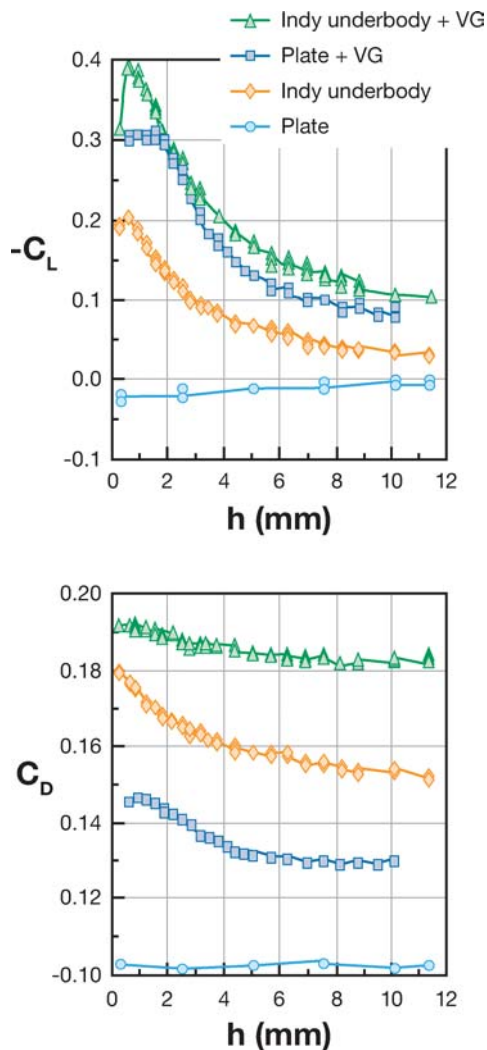

and is quite effective and widely used. Current stock cars use those and Duncan (1990, 1994) provides measured data on their performance. In the early study, Duncan (1990) studied the effect of rear spoiler angles and showed that rear downforce increases with larger angles (measured from the horizontal plane). The effect of a 60-deg rear spoiler was about $\Delta C_L \sim -0.20$. In his second study, Duncan (1994), in addition to the study of rear spoilers, also discusses the condition when one vehicle is drifting behind the other. One of his interesting findings is the reduction in the drag of both vehicles. The trailing vehicle benefits from the large wake of the front car while the front car gains (in terms of reduced drag) due to the higher base pressure.

Schekel (1977) tested spoilers under the chin of the car on a sedan-type vehicle, showing positive effect on front downforce. Apart from reducing the pressure below

the front underbody of the car, they have a positive effect on the flow across front-mounted radiators. Among several other studies, the work of Good et al. (1995) is one of the most interesting. He investigated the combined effect of front and boot spoilers (on sedans) of various sizes and compared the results of track and wind tunnel testing. The trends were similar but the track drag data were higher. Their focus was more on drag reduction and validation of wind tunnel tests, but an increase in downforce resulted in more drag.

To end the discussion on downforce, several references containing aerodynamic information on various race cars are quoted. In some forms of racing underbody diffusers are allowed whereas for others only simple add-ons can be used. Duncan (1994) presents typical results for a complete stock car, emphasizing the effect of rear spoilers. Katz & Dykstra (1992) present similar data for enclosed wheel sedan and prototype race cars, focusing on wing/body interactions. One of the few race car manufacturer-supported data on open-wheel race cars is presented by Page (2000) and includes information on downforce and drag of Indy cars. Johansson & Katz (2002) tested a generic sprint car configuration and provided a wide range of aerodynamic data on such asymmetric vehicles. Land-speed record car aerodynamic was discussed by Torda & Morel (1971), who showed that compressibility effects increase the vehicle drag as it approaches the sonic speed.

Methods Used for Evaluating Vehicle Aerodynamics

Aerodynamic evaluation and refinement is a continuous process and an integral part of race car engineering, which is not limited to the vehicle initial design phase only. Typical analysis and evaluation tools used in this process may include wind tunnel testing, computational prediction, or track testing. Each of these methods may be more suitable for a particular need and, for example, a wind tunnel or a numeric model can be used during the initial design stage prior to the vehicle being built. Once a vehicle exists, it can be instrumented and tested on the track. In the following paragraphs I discuss these three basic methods (e.g., wind tunnel, computational methods, and track testing) and their applicability for aerodynamic prediction and validation.

Wind Tunnel Methods

During the 1960s, just when the significance of aerodynamics for race car design was realized, wind tunnel methodology was already mature and widely used by the aerospace industry. It was only logical that wind tunnel testing became an integral part of all race car development projects, as well. Small-scale tests (e.g., Katz 1985a) helped in investigating basic ideas prior to building the vehicle, and validations were performed later on the track with the actual race car. However, wind tunnel testing of a race car posed several difficulties when using traditional aeronautical wind tunnel facilities. The first major problem was due to the small clearance between the vehicle underbody and the stationary floor of the test section (the second problem related to how to mount the rotating wheels). Existing wind tunnel correction methods (see Barlow et al. 1999, ch. 9–11) could not correct for the additional shear layer created

on the test section floor (which does not exist on the track) that blocked the flow beneath the car. Solutions to simulate the moving ground effect emerged in the form of blowing, suction, rolling grounds, or all of the above combined. Schematic descriptions of these methods and model mounting techniques are described briefly by Katz (1995, ch. 3). The effect of small ground clearance on the aerodynamic data was demonstrated by the wind tunnel experiments of Carr & Eckert (1994). They used a rolling ground simulation (which could be stopped) to test several models, including a generic sedan and a race car shape with underbody diffusers. Their data clearly indicate a significant increase in both downforce and drag when the moving ground simulation was used. In an earlier study, Berndtsson et al. (1988) documented the velocity profiles in the boundary layer near the ground and pointed out the importance of rolling ground simulations.

In spite of all the improvements in wind tunnel technology, the aerodynamic effects and wind tunnel mounting of the rotating wheels are not completely resolved. The basic Magnus effect, discussed by Swanson (1961), results in negative lift increment when the tire rotates during the forward motion. However, the contact point between the tire and the ground and loads such as rolling resistance complicate the evaluation of the pure aerodynamic effects. When the wheel rotation is caused by the moving belt, the wheel's contribution to lift is not easily resolved. Even when mounting each wheel separately on its own balance, some of the measuring accuracy may be lost. One interesting solution was proposed by Dimitriou & Garry (2002), who used a narrow belt (between the wheels only) to simulate the ground effect in race car applications. This approach is suitable for full-scale testing of actual race cars and the wheels could be running on drums attached directly to the balance and thereby the wheel mounting issues were resolved. However, the flow near and outside of the wheels may not be correct, but their data showed no major differences when compared with wider rolling ground simulations.

Early small-scale measurements (Katz 1985a) followed airplane model mounting techniques, and the wheels, while attached to the car, were not resting on the wind tunnel floor. This way the aerodynamic loads could be properly measured (from the mechanical point of view) by the balances incorporated into the mounting system. The main problem emerged from the small gap between an isolated wheel and the wind tunnel floor [Katz (1985a) used flexible foam to seal this gap]. This effect was studied early by Cogotti (1983), and more recently by Kano & Yagita (2002). They used a generic cylinder shape to model the wheel and employed both numerical methods and wind tunnel measurements with moving ground simulation. Studies with a complete vehicle focusing on the wheel mounting effects, such as Mercker et al. (1991), show similar results. When the wheel is in contact with the floor and not rotating, a positive lift ($C_D \sim 0.1$) and drag ($C_L \sim 0.5$) force is measured. As the wheel is raised, a significant (false) downforce is created by the accelerated flow in the gap between the wheel and the ground. When adding the effects of moving ground and spinning wheel, the Magnus effect reduces the lift whereas the effect on drag is much smaller. Cogotti (1983) also tested isolated wheels through a wide range of Reynolds numbers and showed that the separation pattern behind the wheel changes above a critical Reynolds number of about 3×10^6 , resulting in a sharp drop in both lift and drag.

As a result of the increased use of wind tunnels for race car development, customized facilities were rapidly developed, all with rolling ground simulation. Most of these facilities were planned for 30% to 50% scale models with rolling ground simulation capabilities near the 200-km/h range. Typically, the model is mounted on an internal six-component balance attached to the wind tunnel ceiling via an aerodynamic strut and the wheels are driven by the rotating belt. The wheels can be attached to the vehicle by using a soft suspension or mounted from the sides using separate balances. The main advantage of this setup is that both ground clearance and a body's angle of attack could be changed easily. However, yaw simulation and wheel lift measurement were more difficult [see sting mount solutions proposed by Page et al. (2002)]. Model size was also a major consideration while developing these facilities. On one hand, cost and space considerations lead to small models, but fabrication difficulties with a too-small model and Reynolds number effects require the largest model affordable. By the end of the millennium a large number of race car wind tunnels were built and Lis (2002) provides a comprehensive guide and description of these various wind tunnels. Some of these facilities can actually simulate full-scale (e.g., true Reynolds number) race conditions. One option for full-scale simulation is to use large aeronautical wind tunnels such as the NASA Langley 30-by-60 foot tunnel (see Lee et al. 2002). In this particular application an actual NASCAR was tested in the wind tunnel, and Lee et al. (2002) describe the use of pressure-sensitive paint to study the three-dimensional surface pressure field.

McBeath (1999) describes one of the most sophisticated race car wind tunnels with rolling ground designed for testing up to 50% scale models up to a maximum speed of 250 km/h. The interesting feature of this wind tunnel is that it can be pressurized up to twice the atmospheric pressure to simulate a full-scale Reynolds number environment. The next step is to test full-scale models, a step that will eliminate duplicate small-scale model fabrication, but will add to the cost of the facility.

Computational Fluid Dynamic Methods

The integration of computational fluid dynamics (CFD) methods into a wide range of engineering disciplines is rising sharply, mainly due to the positive trends in computational power and affordability. One advantage of these methods, when used in the race car industry, is the large body of information provided by the solution. Contrary to wind tunnel tests, the data can be viewed, investigated, and analyzed over and over, after the experiment ends. Furthermore, such virtual solutions can be created before a vehicle is built and can provide information on aerodynamic loads on various components, flow visualization, etc. The main question is why the more expensive (and less informative) wind tunnel and road testing are still being used. The simplest answer is that none of the above tools (e.g., CFD, wind tunnel, or track) are sufficiently comprehensive, and the complementary use of all methods is the safest avenue. To clarify this statement, the applicability of current CFD tools are discussed briefly in the following paragraphs.

There are several components to the question about the applicability of CFD methods. For example, one of the first questions is how close the equations to be

solved simulate the actual physical conditions. Once the equations (e.g., Euler, full Navier-Stokes, etc.) are selected, the next question is how well various algorithms approximate these equations and, of course, which type of solution is affordable from the computational power point of view. Because the main concern of this study is the applicability of these methods to race car design, the numerical aspects are not discussed further and the reader is referred to texts (e.g., Hoffman & Chiang 1993) that describe the basics of these methods. As noted, computational power and affordability seemed to be the last hurdle before the wide use of CFD. On the positive side, computational power is still in its growth mode, and still dictating the complexity of the numerical solutions (e.g., complexity of equations, geometry, etc.). Current capabilities are continuously being validated and evaluated. Laflin et al.'s (2004) study comparing several solution methods (codes) for the flow over a generic airplane configuration is one such example. In general, their conclusion is that the estimation of lift (pressure integral) is more accurate than that of the drag force (shear and flow separation effects). This conclusion is relevant to the high-Reynolds number flow over race cars, as well, dominated by both laminar and turbulent flow regimes and localized flow separations. For example, in cases when the Navier-Stokes equations are solved, a time-averaged approximation is more economical for the turbulent regions. The transitional boundary between laminar and turbulent regions (as with a lifting surface) is a key element in the calculation of the shear forces and the resulting surface drag. To achieve satisfactory engineering results, information on transition boundaries is usually based on experimental observation (because the direct calculation of transition is still out of range). Another area of weakness is the prediction of separation lines, particularly for smooth, moderately curved surfaces. With sharp edges (as on the side of a rectangular box), flow separation is obvious and base pressure predictions are better. Also, separated flows and wakes at this Reynolds number range are time dependent and unsteady models are needed to capture the larger-scale flow structures. On the positive side, grid generation has improved and self-adapting grids can now capture thin boundary-layer effects or vortex patterns in the wake behind the vehicle [for more information on grid generation see textbooks such as that by Hoffman & Chiang (1993)]. In summary, CFD became an important tool for studying the flow over complex configuration such as a race car. It can be used as a preliminary design tool or to complement experimental methods. In providing flow visualization information and details such as the aerodynamic load on an access door, expected pressure drop across a cooler, etc., it is almost irreplaceable. Although CFD is now widely used in the race car industry, archival reports are less than abundant. However, some capabilities can be demonstrated by several of the published studies on this topic.

Early experiments with numerical methods for race car aerodynamic applications were limited by computational resources. In the mid-1980s potential flow-based panel methods matured but still required access to the main frame computers of the era. For example, Katz (1985b) used such a method to investigate the unsteady loads (due to suspension oscillations) on the front wing of an open-wheel race car. About a year later a complete race car model was used to study the interaction between the vehicle body and the front and rear wings. In this study, Katz (1986) showed that the rear wing cannot be designed without considering the curved flow field created by the

vehicle body. Because these methods were based on inviscid fluid equations, the drag prediction was inadequate (it included only the pressure integral), but the downforce calculation included ground effect and interaction with the body. Toward the end of the 1980s the accumulated experience with these methods was used to design two race cars using CFD only (because there was no time for testing). Information on the second vehicle, a prototype race car, is presented by Katz & Dykstra (1994). Because the inviscid methods cannot predict flow separations, an effort was made to design a car that would fit the numerical model (to maximize prediction capability). For example, the trailing edge of the vehicle consisted of a narrow, straight, horizontal line, with basically no flow separation (as observed after the fact). By applying the Kutta condition (see Katz & Plotkin 2002, p. 88–89) to this trailing edge line, the correct circulation was calculated (which was very close to the later-measured downforce). Because of the short development time, all wing surfaces were developed numerically, and subsequent track testing favorably validated the calculations.

Toward the end of the 1990s computer-aided design and computer power enabled the generation of detailed vehicle models and the use of the full Navier-Stokes equation for the solution. Werner et al. (1998) used the Reynolds-averaged Navier Stokes with the $k\epsilon$ turbulence model (see Hoffman & Chiang 1993, vol. II, ch. 17) to study the flow over the entire vehicle. This sedan-based race car was developed for the highly sophisticated German touring car series. The main problem was modeling the flow under the front of the car to generate sufficient front downforce and cooling flow. A similar approach was used by Katz et al. (1998) to study the flow over an open wheel Indy car. Because of the complex interactions, wind tunnel load cell data was often nonlinear and CFD helped to understand the flow field and improve the design. **Figure 15** shows the streamlines initiated at the front wing and forming the wing-tip vortex, moving around the front wheel, and eventually reaching the rear wing. Such flow visualizations, combined with the pressure integration results, established the explanation to the nonlinear front wing flap effect presented in **Figure 7**. Bokulich (2000) reported similar effort, where CFD was used to generate pressure plots, flow visualizations, and vortex trajectories for a similar Indy car. This study emphasizes the complementary contribution of CFD when combined with wind tunnel testing, particularly in resolving the lift and drag contribution of the wheels. In a later work, Brzustowicz et al. (2002, 2003) incorporated CFD into the development of a new NASCAR race car. Their motivation was drag reduction, and a large portion of the drag on this vehicle is due to the highly separated underbody flow, as shown in **Figure 16**. CFD is probably the best tool for evaluating the isolated loads on the highly detailed underbody components in this figure. Because underbody streamlining is not allowed in this form of the sport, minor adjustment can result in a few-mile-per-hour advantage on vehicles traveling close to 200 mph. Another interesting aspect of this study is the inclusion of multivehicle interactions. Because in NASCAR races the vehicles race in very close formations, studying the individual vehicle may not result in a better race car during the race. By investigating the detailed model of the flow under the car in the presence of other vehicles, a more competitive vehicle was developed. When studying the case of drafting (one vehicle close behind the other), Brzustowicz et al.'s (2002) CFD data showed that the front car has less drag

Figure 15

Streamline traces released ahead of the front wing of an Indy-type race car. (Reprinted with permission from Katz et al. (1998), © 1998 SAE International.)

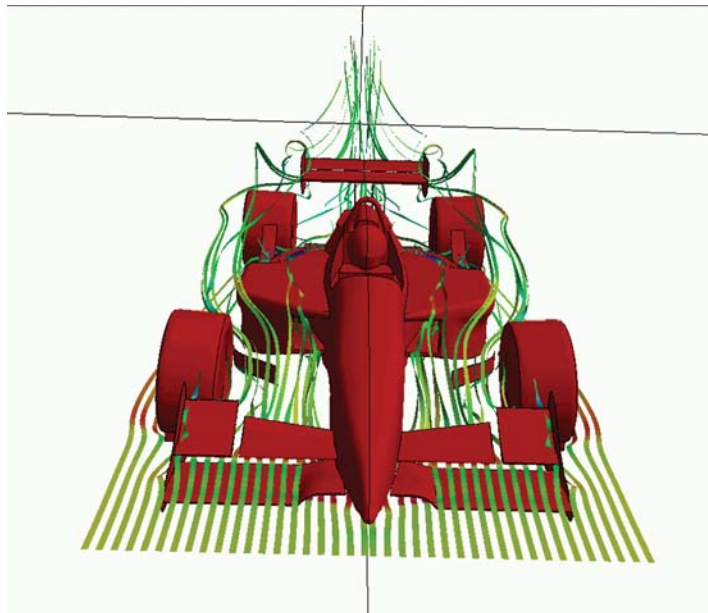

(when the vehicles almost touch) and overtaking by an identical car (from behind) was not likely.

In conclusion, CFD is very useful in the preliminary design phase, before a wind tunnel model exists. It is almost the only approach for effective wing airfoil shape developments because of the detailed pressure and skin friction information. It is a powerful tool for calculating vortex flows and for providing valuable flow visualizations (to explain other experimental observations). Its advantage also lies in the fact that the results can be viewed over and over again and new aspects of the solution can be investigated. As most of the recent studies indicate, CFD is an excellent complementary tool along with other methods such as wind tunnel testing. Its weakness is rooted in scaling issues such as the prediction of transition from laminar to turbulent flows (e.g., boundary layers) or the calculation of separated flow and unsteady wakes.

Figure 16

Streamlines under a stock car. [Reprinted with permission from Brzustowicz et al. (2002), SAE Paper 2002-01-3334, © 2002 SAE International.]

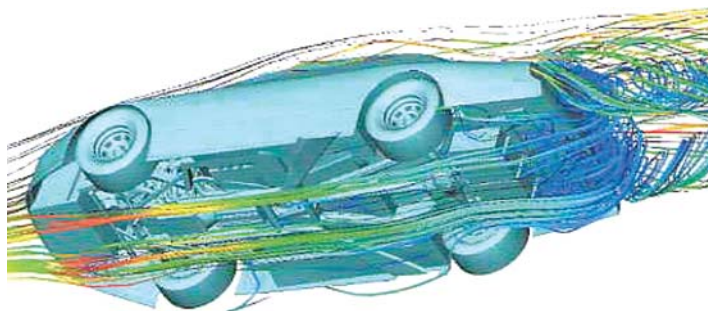

The bottom line is that CFD solutions depend on user-defined elements such as turbulence modeling and grid generation, which many view as the next hurdle facing code developers. Because the large-scale flow regimes over most vehicles depend on the predictability of the aforementioned, i.e., transition and turbulence, the complete flow field cannot yet be modeled economically.

Track Testing

Some difficulties inherent to wind tunnel testing are simply nonexistent in full-scale aerodynamic testing on the race track. Rolling wheels, moving ground, the correct Reynolds number, and wind tunnel blockage correction are all resolved and there is no need to build an expensive, smaller-scale model. Of course, a vehicle must exist, the weather must cooperate, and the cost of renting a track and instrumenting a moving vehicle must not upset the budget. Because of the above-mentioned advantages, and in spite of the uncontrolled weather and cost issues, this form of aerodynamic testing has improved considerably in recent years. One of the earliest forms of testing was the coast down test to determine the drag of a vehicle. In spite of variation in atmospheric conditions and inconsistencies in tire rolling resistance, reasonable incremental data can be obtained, as discussed by Crewe et al. (1996). With the advance in computer and sensor technology, by the end of the 1990s the desirable forces, moments, or pressures could be measured and transmitted via wireless communication at a reasonable cost. Sensors to measure suspension displacement, various stress/strains, drive shaft torques, pressures, temperatures, etc. are available off the shelves. Data acquisition systems (see Petrone et al. 2002) can rapidly analyze loads and provide information such as temperature or pressure drop across the cooling system, downforce, and drag of various components (including wings and wheels). Even flow visualizations can be conducted by installing miniature cameras at various locations to provide information on flow separation, vortex trails, or unplanned recirculation in the cooling system. In spite of the technology becoming highly effective and affordable, race track renting is still quite expensive, and to save cost in many forms of racing the organizers simply limit the number of track test days and some even forbid using telemetry (for engineering purposes) during the race. Because this tool matured only recently and due to the competitive nature of the sport, only limited information was reported on it in the open literature.

RACE CARS AND SAFETY

Vehicle longitudinal stability considerations, as noted at the beginning of this review, require that the center of pressure be behind the center of gravity. At the same time tire side slip is kept under a few degrees ($\beta < 5$ deg) for the same reasons. However, under unplanned circumstances such as collision or loss of control, the vehicle may experience large side slip or even angles of attack conditions, causing it to become unstable. Consequently, some of the research is not directly related to improving vehicle performance but rather to making it safer under unplanned conditions. One example is related to stock car racing (e.g., NASCAR), where the cars race in close

formations and contact between vehicles during the race is not an uncommon event. Occasionally, after such a contact, a vehicle may slide sideways or even rotate slowly and become airborne while its speed is still more than 150 mph. Nelson et al. (1994) showed that during a large side-slip angle (e.g., over 90 deg) lift coefficients in the range of $C_L \sim 1.0$ to 1.4 are possible. For example, at 200 mph about 1.25 tons of lift can be generated, a force that can easily lift off the race car, aggravating the magnitude of the damage. Consequently, Nelson et al. (1994) designed a roof-mounted flap system that self-deploys and causes the flow to separate (spoil the lift) when the vehicle is sliding sideways. These passive devices (actuated aerodynamically) are now used in this form of racing and, according to Nelson et al. (1994), no NASCAR race car has experienced an aero lift off since these roof flaps were mandated.

A similar situation is the top fuel dragster blowover. In this form of racing the vehicle accelerates (up to 4 g) along a fourth of a mile strip, reaching speeds of over 300 mph. When combining the large wheel torque (lifting the front) with structural vibration and road surface imperfections, the front may slightly lift off; still, with additional misfortune the vehicle may become airborne (a condition called blowover). Katz (1996) showed that at 200 mph the vehicle must be pitched up about 3 deg to initiate the blowover (or a much smaller angle at higher speeds). Under normal conditions this is highly unlikely, but blowover did happen (perhaps as a result of small bumps combined with the rear wheel torque lifting off the front). In this study a passive flap was proposed to alleviate this type of accident. The flap delayed the blowover condition from 3 deg to over 10 deg angle of attack, which is a large safety margin.

Racing organizations work continuously to make the sport safer, and some of their measures are aimed at reducing racing speed. Often the regulations are not directly aimed at speed reduction, but rather at reducing downforce. Such is the regulation requiring the use of flat underbody (without tunnels), which is mandated in many forms of racing (also to reduce vehicle development cost). Because open-wheel race cars have a distinct front wing they were less likely (although not immune) to experience blowover at high speeds compared to prototype race cars. In 1999–2000, more such accidents than usual occurred in the LeMans circuit, triggering several studies on this topic. Both the work by Wright (1999) and Dominy et al. (2000) argued that several degrees of pitch are needed to make a prototype race car airborne at speeds over 300 km/h. Dominy et al. (2000) used one-fifth scale wind tunnel testing of a generic LeMans GTP car with various ground clearance and pitch angles. They showed that even small pitch variation (e.g., increasing) can result in a rapid forward movement of the center of pressure, leading to catastrophic takeoff. A similar study with an open-wheel Indy car model (Katz et al. 2004) showed that the lift slope of prototype race cars is larger due to the larger planview area and the larger area concentration near the front of the vehicle. It was also noted that a flat rear tire at 300 km/h can pitch up the car by more than two degrees, which is sufficient to initiate the aerodynamic liftoff. It must be reiterated, though, that all of these studies indicate that the vehicles under normal operating conditions are stable aerodynamically and cannot take off. There must be a combination of events such as a large bump, mechanical failure, or contact with another vehicle that increase the vehicle's pitch angle to a point where front downforce is lost.

Another interesting safety-oriented study is by Wallis & Quinlan (1988), who studied the aerodynamic interaction between a stock race car and the retaining wall. Because of the large number of cars competing at the same time, racing three abreast and close to the wall is quite common. Using a 3/8-scale wind tunnel model they showed that when the vehicle is approaching the wall the aerodynamic loads vary significantly, altering the vehicle's balance. Of particular interest is the increase in front lift (or loss in downforce) as the vehicle approaches the wall, compared to a much smaller change in the rear, hence influencing handling. They suggested inclining the wall by 20 deg (away from the car) to reduce this effect.

The aerodynamic interaction between two or more vehicles can alter vehicle balance and directly affects all safety aspects. Stock cars (e.g., NASCAR), for example, are racing and drafting closely and aerodynamic effects on handling are significant. Also, overtaking becomes difficult because both aerodynamic drag and balance change when the vehicles change positions. The reduction in drag for both vehicles was already mentioned when discussing the wind tunnel experiments of Duncan (1994) and the CFD calculations of Brzustowicz et al. (2002). This observation can be extended to a larger number of cars following each other closely. Zambat et al. (1994) experimented with up to four passenger vehicles models following each other closely. In all cases, when the separation distance was reduced, the drag of each vehicle was reduced. Clearly, the forward car gains from the reduction in base drag while the trailing vehicle benefits from the reduction in the incoming momentum. For high-downforce open-wheel or prototype race cars the loss of downforce is a major concern, particularly for the following car. According to McBeath (2004), who studied F1-type cars, close to 50% of the front wing's downforce (for the following car) can be lost when the separation distance is below one half the car length. Also, rear downforce and drag are reduced, but the center of pressure shift is only on the order of a few percents. Results for the leading car show much smaller effects consisting mainly of several percent rear downforce loss, with negligible effect on center of pressure shifts.

CONCLUDING REMARKS

The complexity of automobile and race car aerodynamics is comparable to airplane aerodynamics and is not limited to drag reduction only. The generation of downforce and its effect on lateral stability has a major effect on race car performance, particularly when high-speed turns are involved. In the process of designing and refining current race car shapes, all aerospace-type design tools are used. Because of effects such as flow separations, vortex flows, or boundary-layer transition, the flow over most types of race cars is not always easily predictable. Due to the competitive nature of this sport and the short design cycles, engineering decisions must rely on combined information from track, wind tunnel, and CFD tests.

LITERATURE CITED

Barlow JB, Rae WH Jr, Pope A. 1999. *Low-Speed Wind Tunnel Testing*. New York: Wiley. 3rd ed.

- Berndtsson A, Eckert WT, Mercker E. 1988. The effect of groundplane boundary layer control on automotive testing in a wind tunnel. *SAE 880248*
- Bokulich F. 2000. Getting the aero advantage. *Automot. Eng. Int.* 108(11):56–58
- Brzustowicz J, Lounsberry T, Esclafer de la Rode JM. 2003. Improving racecar aerodynamics. *SAE Automot. Eng.* 111(5):95–98
- Brzustowicz JP, Lounsberry TH, Esclafer de la Rode JM. 2002. Experimental and computational simulations utilized during the aerodynamic development of the Dodge Intrepid R/T race car. *SAE 2002-01-3334*
- Buchholz MD, Tso J. 2000. Lift augmentation on delta wing with leading-edge fences and Gurney flap. *J. Aircr.* 37(6):1050–57
- Carr GW, Eckert W. 1994. A further evaluation of the groundplane suction method for ground simulation in automotive wind tunnels. *SAE 940418*
- Carrannanto PG, Storms BL, Ross JC, Cummings RM. 1994. Navier-Stokes analysis of lift-enhancing tabs on multi-element airfoils. *AIAA 94-0050*
- Cogotti A. 1983. Aerodynamic characteristics of car wheels. *Int. J. Veh. Des.* SP 3:173–96
- Cooper KR, Bertenyi T, Dutil G, Syms J, Sovran G. 1998. The aerodynamic performance of automotive underbody diffusers. *SAE 980030*
- Coulliette C, Plotkin A. 1996. Aerofoil ground effect revisited. *Aeronaut. J.* 1996:65–74
- Crewe CM, Passmore MA, Symonds P. 1996. Measurement of Formula One car drag force on the test track. *SAE 962517*
- Dimitriou I, Garry KP. 2002. Use of a narrow belt for moving ground simulation and its effect on the aerodynamic forces generated on a Formula 1 car. *SAE 2002-01-3342*
- Dominy RG, Ryan A, Sims-Williams DB. 2000. The aerodynamic stability of a Le Mans prototype race car under off-design pitch conditions. *SAE 2000-01-0872*
- Duncan LT. 1990. Wind tunnel and track testing an ARCA race car. *SAE 901867*
- Duncan LT. 1994. The effect of deck spoilers and two-car interference on the body pressures of race cars. *SAE 942520*
- Falconer R, Nye D. 1992. *Chaparral*. Osceole, WI: Motorbooks Int.
- Garcia D, Katz J. 2003. Trapped vortex in ground effect. *AIAA J.* 41(4):674–78
- George AR. 1981. Aerodynamic effects of shape, camber, pitch, and ground proximity on idealized ground-vehicle bodies. *ASME J. Fluids Eng.* 103(12):631–38
- George AR, Donis JE. 1983. Flow patterns, pressures, and forces on the underside of idealized ground effect vehicles. In *Aerodynamics of Transportation II*, ed. T Morel, J Miller, 7:69–79. New York: ASME
- Glauert H. 1926. *The Elements of Airfoil and Airscrew Theory*. London: Cambridge Univ. Press
- Hoefler C. 1978. Lotus 78—Moderne Formula 1—Tech. *ATZ* 80(7/8):305–8 (In German)
- Hoerner SF. 1985. *Fluid Dynamic Lift*. Bakersfield, CA: Hoerner Fluid Dyn.
- Hoffman KA, Chiang ST. 1993. *Computational Fluid Dynamics for Engineers*, Vols. 1, 2. Wichita, KS: Eng. Educ. Syst. 2nd ed.
- Hucho WH. 1998. *Aerodynamics of Road Vehicles*. Warrendale, PA: SAE Int. 4th ed.

- Jeffrey D, Zhang X, Hurst DW. 2001. Some aspects of the aerodynamics of Gurney flaps on a double-element wing. *J. Fluids Eng.* 123:99–104
- Johansson M, Katz J. 2002. Lateral aerodynamics of a generic Sprint car configuration. *SAE J. Passenger Cars: Mech. Syst.*, pp. 2331–38. *SAE 2002-01-3312*
- Kano I, Yagita M. 2002. Flow around a rotating circular cylinder near a moving plane wall. *JSM Int. J. Ser. B* 45(2):259–68
- Katz J. 1985a. Investigation of negative lifting surfaces attached to an open-wheel racing car configuration. *SAE Pap.* 85-0283
- Katz J. 1985b. Calculation of the aerodynamic forces on automotive lifting surfaces. *ASME J. Fluids Eng.* 107(4):438–43
- Katz J. 1986. Aerodynamic model for wing-generated down force on open-wheel-racing-car configurations. *SAE Pap.* 86-0218
- Katz J. 1989. Aerodynamics of high-lift, low aspect-ratio unswept wings. *AIAA J.* 27(8):1123–24
- Katz J. 1994. Considerations pertinent to race-car wing design. *R.A.C. Conf. Veh. Aerodyn. Pap.* 23, July 18, Loughborough, Engl.
- Katz J. 1995. *Race-Car Aerodynamics*. Cambridge, MA: Bentley
- Katz J. 1996. *Aerodynamics and possible alleviation of top-fuel dragster 'blow-over.'* Presented at SAE 2nd Int. Motorsport Conf., Detroit, Dec. Veh. Des. Issues, SAE P-304/1, pp. 115–19. *SAE Pap.* 96-2519
- Katz J, Dykstra L. 1989. *Study of an open-wheel racing-car's rear wing aerodynamics.* Presented at the SAE Int. Conf., Feb., SAE Pap. 89-0600
- Katz J, Dykstra L. 1992. *Effect of wing/body interaction on the aerodynamics of two generic racing cars.* Presented at SAE Int. Conf., Detroit, Feb., SAE 92-0349
- Katz J, Dykstra L. 1994. *Application of computational methods to the aerodynamic development of a prototype race-car.* Presented at SAE 1st Motor Sport Eng. Conf., Dec. 5–8, Detroit, P-287, pp. 161–69. *SAE Pap.* 942498
- Katz J, Garcia D. 2002. Aerodynamic effects of Indy car components. *SAE J. Passenger Cars: Mech. Syst.*, pp. 2322–30. *SAE 2002-01-3311*
- Katz J, Garcia D, Sluder R. 2004. Aerodynamics of race car liftoff. *SAE 2004-01-3506*
- Katz J, Largman R. 1989a. Effect of 90 degree flap on the aerodynamics of a two-element airfoil. *ASME J. Fluids Eng.* 111(March):93–94
- Katz J, Largman R. 1989b. Experimental study of the aerodynamic interaction between an enclosed-wheel racing-car and its rear wing. *ASME J. Fluids Eng.* 111(2):154–59
- Katz J, Luo H, Mestreau E, Baum J, Lohner R. 1998. *Viscous-flow simulation of an open-wheel race car.* Presented at Motor Sport Eng. Conf., Detroit, Nov. 16, SAE Spec. Publ. Veh. Des. Safety Issues, P-340/1, pp. 87–93. *SAE Pap.* 983041
- Katz J, Plotkin A. 2002. *Low-Speed Aerodynamics*. Cambridge, UK: Cambridge Univ. Press. 2nd ed.
- Lafin KR, Klauzmeier ST, Zickuhr T, Vassberg JC, Wahls RA, et al. 2004. *IAA CFD Drag Prediction Workshop, 2nd, AIAA 2004-0555, Reno, NV*
- Lee S, Landman D, Jordan J, Watkins A, Leighty B, et al. 2002. Performance automotive applications of pressure-sensitive paint in the Langley full-scale tunnel. *SAE 2002-01-3291*

- LeGood GM, Howell JP, Passmore MA, Garry KP. 1995. On-road aerodynamic drag measurements compared with Wind Tunnel Data. *SAE 950627*
- Liebeck RH. 1973. A class of airfoils designed for high lift in incompressible flow. *J. Aircr.* 10(10):610–17
- Liebeck RH. 1978. Design of subsonic airfoils for high lift. *J. Aircr.* 15(9):547–61
- Lis A. 2002. Buyers Guide, Wind Tunnels. *Race Tech.* 43(Aug./Sept.):75–78. Provides a comprehensive list + a short description of race car oriented wind tunnels in the world
- McBeath S. 1999. Benetton under pressure. *Racecar Eng.* 9(2):22–24
- McBeath S. 2004. Two-car airflow: Draft dodging. *Racecar Eng.* 14(10):50–54
- Mercker E, Breuer N, Berneburg H, Emmelmann HJ. 1991. On the aerodynamic interference due to the rolling wheels of passenger cars. *SAE 910311*
- Metz DL. 1985. Aerodynamic requirements at the Indianapolis Motor Speedway. *J. Guid.* 8(4):530–32
- Milliken WF, Milliken DL. 1995. *Race Car Vehicle Dynamics*. Warrendale, PA: SAE Int.
- Myose RY, Papadakis M, Heron I. 1996. The effect of Gurney flaps on three-dimensional wings with and without taper. *AIAA 96-5514. 1996 World Aviat. Congr., Los Angeles, CA*
- Nelson G, Roush J, Eaker G, Wallis S. 1994. The development on manufacture of a roof mounted aero flap system for race car applications. *SAE 942522*
- Neuhart DH, Pendergraft OC. 1988. A water tunnel study of Gurney flaps. *NASA TM 4071*
- Page M, Winkler J, Roberts N, Huschilt T, Smyth D, Kane B. 2002. Recent upgrades to the swift 8 ft × 9 ft rolling-road, wind tunnel. *SAE 2002-01-3341*
- Page MA. 2000. *Aerodynamic design of the Eagle E997 champ car*. Presented at 18th Appl. Aerodyn. Conf., Denver, CO, Aug. 14–17. AIAA 2000-4337
- Papadakis M, Myose RY, Matallana S. 1997. Experimental investigation of Gurney flaps on a two-element general aviation, airfoil. *AIAA 97-0728. 35th Aerospace Sci. Meet. Reno, NV*
- Piolesesi E. 1935. Ground effect—Theory and practice. *NACA TM-828*
- Petrone N, Capuzzo M, DePaoli E. 2002. Acquisition and analysis of aerodynamic loads on formula 3 racing car wings using dynamometric load cells. *SAE 2002-01-3331*
- Polhamus EC. 1971. Prediction of Vortex characteristics by a leading-edge suction analogy. *J. Aircr.* 8(4):193–99
- Poncini GF, Di Giusto N. 1983. Experimental methods for wind-tunnel testing of racing cars with ground effect. *Int. J. Veh. Des. Impact Aerodyn. Veh. Des.* SP3:480–92
- Ross JC, Storms BL, Carrannanto PG. 1995. Lift-enhancing tabs on multi-element airfoils. *J. Aircr.* 32(3):649–55
- Ruhrmann A, Zhang X. 2003. Influence of diffuser angle on a bluff body in ground effect. *J. Fluids Eng.* 125:332
- Schekel FK. 1977. The origins of drag and lift reductions on automobiles with front and rear spoilers. *SAE Pap.* 77-0389

- Senior AE, Zhang X. 2001. The force and pressure of a diffuser-equipped bluff body in ground effect. *J. Fluids Eng.* 123:105
- Swanson WM. 1961. The Magnus effect: A summary of investigations to date. *Trans. ASME J. Eng.* 83-3, pp. 461-70
- Torda TP, Morel TA. 1971. Aerodynamic design of a Land Speed Record car. *J. Aircr.* 8:1029-33
- Wallis SB, Quinlan WJ. 1988. A discussion of aerodynamic interference effects between a race car and a race track retaining wall (A Wind Tunnel NASCAR Case Study). *SAE 880458*
- Werner F, Frik S, Schulze J. 1998. Aerodynamic optimization of the Opel Calibra ITC racing car using experiments and CFD. *SAE 980040*
- Wiedemann J. 1989. Some basic investigations into the principles of ground simulation techniques in automotive wind tunnels. *SAE 890369*
- Wright P. 1999. Cleared for take-off. *Racecar Eng.* 9(7):16-18
- Wright P. 1983. The influence of aerodynamics on the design of Formula One racing cars. *Int. J. Veh. Impact Aerodyn. Veh. Des.* SP 3:158-72
- Zambat M, Frascaroli S, Browand FK. 1994. Drag measurements on 2, 3, and 4 car platoons. *SAE 940421*
- Zerihan J, Zhang X. 2000. Aerodynamics of a single element wing in ground effect. *J. Aircr.* 37(6):1058-64
- Zerihan J, Zhang X. 2001. Aerodynamics of Gurney flaps on a wing in ground effect. *ALAA J.* 39(5):772-80
- Zhang X, Zerihan J. 2003. Aerodynamics of a double-element wing in ground effect. *ALAA J.* 41(6):1007-16



Contents

| | |
|--|-----|
| Nonlinear and Wave Theory Contributions of T. Brooke Benjamin (1929–1995) <i>J.C.R. Hunt</i> | 1 |
| Aerodynamics of Race Cars <i>Joseph Katz</i> | 27 |
| Experimental Fluid Mechanics of Pulsatile Artificial Blood Pumps <i>Steven Deutsch, John M. Tarbell, Keefe B. Manning, Gerson Rosenberg, and Arnold A. Fontaine</i> | 65 |
| Fluid Mechanics and Homeland Security <i>Gary S. Settles</i> | 87 |
| Scaling: Wind Tunnel to Flight <i>Dennis M. Bushnell</i> | 111 |
| Critical Hypersonic Aerothermodynamic Phenomena <i>John J. Bertin and Russell M. Cummings</i> | 129 |
| Drop Impact Dynamics: Splashing, Spreading, Receding, Bouncing... <i>A.L. Yarin</i> | 159 |
| Passive and Active Flow Control by Swimming Fishes and Mammals <i>F.E. Fish and G.V. Lauder</i> | 193 |
| Fluid Mechanical Aspects of the Gas-Lift Technique <i>S. Guet and G. Ooms</i> | 225 |
| Dynamics and Control of High-Reynolds-Number Flow over Open Cavities <i>Clarence W. Rowley and David R. Williams</i> | 251 |
| Modeling Shapes and Dynamics of Confined Bubbles <i>Vladimir S. Ajaev and G.M. Homsy</i> | 277 |
| Electrokinetic Flow and Dispersion in Capillary Electrophoresis <i>Sandip Ghosal</i> | 309 |
| Walking on Water: Biolocotion at the Interface <i>John W.M. Bush and David L. Hu</i> | 339 |

| | |
|---|-----|
| Biofluidmechanics of Reproduction <i>Lisa J. Fauci and Robert Dillon</i> | 371 |
| Long Nonlinear Internal Waves <i>Karl R. Helfrich and W. Kendall Melville</i> | 395 |
| Premelting Dynamics <i>J.S. Wettlaufer and M. Grae Worster</i> | 427 |
| Large-Eddy Simulation of Turbulent Combustion <i>Heinz Pitsch</i> | 453 |
| Computational Prediction of Flow-Generated Sound <i>Meng Wang, Jonathan B. Freund, and Sanjiva K. Lele</i> | 483 |

INDEXES

| | |
|--|-----|
| Subject Index | 513 |
| Cumulative Index of Contributing Authors, Volumes 1–38 | 529 |
| Cumulative Index of Chapter Titles, Volumes 1–38 | 536 |

ERRATA

An online log of corrections to *Annual Review of Fluid Mechanics* chapters may be found at <http://fluid.annualreviews.org/errata.shtml>