



# MULTI-INPUT AND MULTI-OUTPUT NONLINEAR SYSTEMS: INTERCONNECTED CHUA'S CIRCUITS

ZHISHENG DUAN\*, JINZHI WANG and LIN HUANG

*Department of Mechanics and Engineering Science,  
Peking University, Beijing, 100871, China*

*\*duanzs@pku.edu.cn*

Received July 16, 2003; Revised December 22, 2003

In this paper, a class of MIMO nonlinear systems are studied. Some frequency domain conditions are established for the property of dichotomy. These kinds of systems can also be viewed as a class of interconnected systems composed of SISO systems through some linear and nonlinear interconnections. A class of nonlinear input and output interconnections are presented. The corresponding condition for testing dichotomy is given. Furthermore, Chua's circuit and interconnected Chua's circuit are studied to illustrate the theoretical results.

*Keywords:* Dichotomy; interconnection; Chua's circuit; coupled Chua's circuit.

## 1. Introduction

The frequency domain method has obtained great success in system analysis [Anderson, 1967; Basso *et al.*, 1996; Leonov & Sminova, 1996b]. Some classical results were established such as Yakubovich–Kalman frequency domain theorem [Leonov *et al.*, 1996a; Huang, 2003] in which the well-known Popov criterion and Circle criterion for absolute stability can be viewed as special cases, Hopf bifurcation theorem [Moiola & Chen, 1996] which can determine periodic solution and limit cycle of a nonlinear system. Several global properties of solutions such as Lagrange stability, Bakaev stability, dichotomy and gradient-like behavior for a class of nonlinear systems with multiple equilibria were studied sufficiently and the corresponding frequency domain conditions were established in [Leonov *et al.*, 1996a]. Dichotomy is a main concept involved in this paper. For such kind of systems the existence of limit cycles or strange attractors is impossible.

In the past two decades, Chua's circuit has attracted a large number of researchers because of its rich and colorful dynamical behavior [Chen &

Dong, 1998; Chua, 1994; Chua *et al.*, 1986; Jorge & Chua, 1999; Shil'nikov, 1993]. This simple electronic circuit plays an ideal paradigm for research on chaos and bifurcation by means of both laboratory experiments and computer simulations. The various literature references show that the study of Chua's circuit is a universal problem. Except for single Chua's circuit, one-way coupled Chua's circuits were studied in [Kapitaniak *et al.*, 1994; Imai *et al.*, 2002]. In addition, chaotic Lur'e systems were studied in [Suykens *et al.*, 1997a, 1997b, 1998]. Master-slave synchronization schemes for Lur'e systems were investigated sufficiently. Many systems of common interest such as Chua's circuits and arrays of Chua's circuits both for unidirectional and mutual coupling can be represented in Lur'e form.

The interconnection plays a main role in large scale systems [Siljak, 1978]. For two given subsystems, the characteristics of the composite system are mainly determined by the interconnections. Every large scale system can be viewed as a system composed of subsystems through some interconnections. Though the idea of harmonic control

appeared very early, there are few results in this area. In this paper we first study the acts of the input and output interconnections for given systems. Furthermore, we show the effects of interconnections through interconnected Chua’s circuits. The rest of this paper is organized as follows. In Sec. 2, some preliminary results are given. In Sec. 3, a main result for a class of multi-input and multi-output (MIMO) systems is presented. In order to study the acts of the input and output interconnections, we must study MIMO systems first. In Sec. 4, a class of input and output interconnections are presented. The corresponding condition for testing dichotomy is presented for interconnected systems. An example is given to show the effects of the interconnection. In Sec. 5, the differences between the definitions of global stability, dichotomy and quasi-dichotomy are clarified through Chua’s circuit. In Sec. 6, interconnected Chua’s circuits are studied. Different results are shown for the interconnected Chua’s circuit generated by an oscillating Chua system and a dichotomous Chua system. In Sec. 7, one-way coupled Chua’s circuit is analyzed similarly. It shows that a chaotic Chua’s circuit and a dichotomous Chua’s circuit can generate a dichotomous Chua’s system after one-way connection. The last section concludes the paper.

Throughout this paper,  $A < 0$  means that  $A$  is a Hermitian and negative definite matrix. The superscript  $*$  means transpose for real matrices or conjugate transpose for complex matrices.  $\text{Re}\{Y\}$  means  $\frac{1}{2}(Y + Y^*)$  for any real or complex square matrix  $Y$ .

## 2. Preliminaries

First, we introduce the definition of dichotomy and two important lemmas. Consider the following system,

$$\dot{x} = f(t, x), \tag{1}$$

where  $f : \mathbf{R}_+ \rightarrow \mathbf{R}^n$  is continuous and locally Lipschitz continuous in the second argument. Suppose that every solution  $x(t; t_0, x_0)$  of system (1) with  $t_0 \geq 0$ , and  $x(t_0) = x_0 \in \mathbf{R}^n$  can be continued to  $[t_0, +\infty)$ .

**Definition 1.** Equation (1) is said to be dichotomous if every bounded solution is convergent to a certain equilibrium of (1). It is called quasi-dichotomous if every bounded solution is quasi-convergent, i.e. every bounded solution  $x(t)$  satisfies

$\text{dist}(x(t), \Lambda) \rightarrow 0$  as  $t \rightarrow +\infty$  where  $\Lambda$  is the set of equilibria of (1) and  $\text{dist}(x(t), \Lambda) = \inf_{z \in \Lambda} |x - z|$ .

The following well-known Yakubovich–Kalman theorem provides a foundation for getting the frequency-domain conditions for testing stability of a class of nonlinear systems [Leonov et al., 1996a; Huang, 2003]. For example, circle criterion and Popov criterion for absolute stability can be implied by Yakubovich–Kalman theorem. Let  $A$  and  $B$  be complex matrices with orders  $n \times n$  and  $n \times m$ , respectively and

$$\mathcal{G}(x, \xi) = x^*Gx + 2 \text{Re}\{x^*D\xi\} + \xi^*\Gamma\xi$$

be an Hermitian form of  $x \in \mathbf{C}^n$  and  $\xi \in \mathbf{C}^m$ ,  $G = G^*$ ,  $\Gamma = \Gamma^*$  and  $D$  are complex matrices with orders  $n \times n$ ,  $m \times m$  and  $n \times m$  respectively.

**Lemma 1.** Suppose that  $(A, B)$  is controllable. Then there exists a matrix  $H = H^*$  satisfying the inequality

$$2 \text{Re}\{x^*H(Ax + B\xi)\} + \mathcal{G}(x, \xi) \leq 0 \quad x \in \mathbf{C}^n, \xi \in \mathbf{C}^m$$

if and only if

$$\mathcal{G}((iwI - A)^{-1}B\xi, \xi) \leq 0$$

for all  $\xi \in \mathbf{C}^m$  and all  $w \in \mathbf{R}$  with  $\det(iw - A) \neq 0$ . In case  $A$  and  $B$  are real matrices,  $H$  is real as well.

For a given linear system, write the lemma above in matrix inequality, one can get the following well-known KYP lemma [Popov, 1973; Rantzer, 1996] which establishes the relationship between frequency domain method and time domain method for linear systems.

**Lemma 2.** Given  $A \in \mathbf{R}^{n \times n}$ ,  $B \in \mathbf{R}^{n \times m}$ ,  $M = M^* \in \mathbf{R}^{(n+m) \times (n+m)}$ , with  $\det(iwI - A) \neq 0$  for  $w \in \mathbf{R}$  and  $(A, B)$  is controllable. The following two statements are equivalent:

- (i)  $\begin{pmatrix} (iwI - A)^{-1}B \\ I \end{pmatrix}^* M \begin{pmatrix} (iwI - A)^{-1}B \\ I \end{pmatrix} \leq 0 \quad \forall w \in \mathbf{R}.$
- (ii) there is a real symmetric matrix  $P$  such that  $M + \begin{pmatrix} PA + A^*P & PB \\ B^*P & 0 \end{pmatrix} \leq 0.$

The corresponding equivalence for strict inequalities holds even if  $(A, B)$  is not controllable.

## 3. A Class of MIMO Nonlinear Systems

In this paper we mainly consider the following system

$$\frac{dy}{dt} = Ay + B\varphi(x), \tag{2}$$

where  $A \in \mathbf{R}^{n \times n}$ ,  $B \in \mathbf{R}^{n \times m}$ ,  $n > m$ ,  $y = (y_1, \dots, y_n)^*$ ,  $x = (x_1, \dots, x_m)^* = (y_1, \dots, y_m)^*$ ,  $\varphi(x) = (\varphi_1(x_1), \dots, \varphi_m(x_m))^*$ . Viewing  $dx/dt$  as the output, then system (2) can be viewed as an MIMO system. Let  $C$  be the matrix composed of the first  $m$  rows of  $A$ , and  $R$  be the matrix composed of the first  $m$  rows of  $B$ . Then the transfer function from  $\varphi(x)$  to  $\dot{x}$  is

$$K(p) = C(pI - A)^{-1}B + R.$$

Obviously,  $K(0) = 0$ . Suppose that  $A$  is nonsingular, and  $\varphi_i : \mathbf{R} \rightarrow \mathbf{R}$  is continuous, piecewise continuously differentiable and there exist  $\mu_{i1}, \mu_{i2}$  such that

$$\begin{aligned} -\infty < \mu_{i1} \leq \varphi'_i(\tau) \leq \mu_{i2} < +\infty, \\ \text{when } \varphi'_i(\tau) \text{ exists, } \quad i = 1, \dots, m. \end{aligned} \quad (3)$$

Any equilibrium  $y_{eq}$  of (2) satisfies

$$y_{eq} = -A^{-1}B\varphi(x_{eq}).$$

Let  $\mu_1 = \text{diag}(\mu_{11}, \dots, \mu_{m1})$ ,  $\mu_2 = \text{diag}(\mu_{21}, \dots, \mu_{m2})$ . Then one can get the following result by the method in [Leonov *et al.*, 1996a].

**Theorem 1.** *Suppose that  $A$  has no pure imaginary eigenvalues,  $(A, B)$  is controllable and  $(A, C)$  is observable. If (2) has isolated equilibria and there exist diagonal matrices  $\varepsilon = \text{diag}(\varepsilon_1, \dots, \varepsilon_m) > 0$ ,  $\tau = \text{diag}(\tau_1, \dots, \tau_m) \geq 0$  and  $\kappa = \text{diag}(\kappa_1, \dots, \kappa_m)$  such that the following frequency domain inequality holds:*

$$\begin{aligned} \text{Re}\{\kappa K(iw) + K^*(iw)\varepsilon K(iw) - [\mu_1 K(iw) \\ - iwI]^* \tau [\mu_2 K(iw) - iwI]\} \leq 0, \quad \forall w \in \mathbf{R}. \end{aligned} \quad (4)$$

Then system (2) is dichotomous.

*Proof.* By the condition given above for  $\varphi$ , we know that  $d\varphi(x(t))/dt$  exists for almost all  $t \geq 0$ . Then we first introduce the following notations

$$\begin{aligned} Q &= \begin{pmatrix} A & B \\ 0 & 0 \end{pmatrix}, \quad L = \begin{pmatrix} 0 \\ I_m \end{pmatrix}, \\ D &= \begin{pmatrix} C^* \\ R^* \end{pmatrix}, \quad z(t) = \begin{pmatrix} y(t) \\ \varphi(x(t)) \end{pmatrix}, \end{aligned}$$

where  $Q, L, D$  are matrices with orders  $(n + m) \times (n + m)$ ,  $(n + m) \times m$ ,  $(n + m) \times m$  respectively and  $z : \mathbf{R}_+ \rightarrow \mathbf{R}^{n+m}$ . It is obvious that any solution of system (2) satisfies the system

$$\frac{dz(t)}{dt} = Qz(t) + L\xi(t), \quad \frac{dx(t)}{dt} = D^*z(t), \quad t \geq 0, \quad (5)$$

where  $\xi(t) = d\varphi(x(t))/dt$ . By the definitions of  $Q$  and  $L$ , it is clear that  $(Q, L)$  is controllable in terms of the controllability of  $(A, B)$ . And one can get that

$$D^*(pI - Q)^{-1}L = \frac{1}{p}K(p), \quad L^*(pI - Q)^{-1}L = \frac{1}{p}I_m.$$

Then let us consider the Hermitian form

$$\begin{aligned} \mathcal{G}(z, \xi) &= \text{Re}\{z^* D \varepsilon D^* z + z^* L \kappa D^* z \\ &\quad + (\mu_1 D^* z - \xi)^* \tau (\xi - \mu_2 D^* z)\} \end{aligned}$$

and the quadratic form

$$\begin{aligned} G(z, \xi) &= 2z^* H(Qz + L\xi) + z^* D \varepsilon D^* z \\ &\quad + z^* L \kappa D^* z + (\mu_1 D^* z - \xi)^* \tau (\xi - \mu_2 D^* z) \end{aligned}$$

for  $z \in \mathbf{R}^{n+m}$ ,  $\xi \in \mathbf{R}^m$ , where  $H$  is a certain Hermitian matrix. Obviously for all complex numbers  $p \neq 0$  which do not coincide with eigenvalues of  $A$  the following equality is valid.

$$\begin{aligned} \mathcal{G}((pI - Q)^{-1}L\xi, \xi) &= |p|^{-2} \xi^* \text{Re}\{\kappa K(p) + K^*(p)\varepsilon K(p) \\ &\quad - (\mu_1 K(p) - pI)^* \tau (\mu_2 K(p) - pI)\} \xi, \\ &\quad \forall \xi \in \mathbf{C}^m. \end{aligned}$$

In virtue of condition (4) we have that

$$\mathcal{G}((iwI - Q)^{-1}L\xi, \xi) \leq 0, \quad \forall \xi \in \mathbf{C}^m, \quad w \neq 0. \quad (6)$$

Therefore, it follows from Lemma 1 that there exists a symmetric real matrix  $H$  such that

$$\begin{aligned} 2 \text{Re}\{z^* H(Qz + L\xi)\} + \mathcal{G}(z, \xi) &\leq 0, \\ \forall z \in \mathbf{R}^{n+m}, \quad \xi \in \mathbf{R}^m. \end{aligned} \quad (7)$$

Let  $w(t) = z^*(t)H z(t)$ . By (3) and (7), along system (5) we have

$$\dot{w}(t) + \varphi^*(x(t))\kappa \dot{x}(t) + \dot{x}^*(t)\varepsilon \dot{x}(t) \leq 0.$$

Integrating the two sides of the inequality above, one gets

$$\begin{aligned} \sum_{i=1}^m \varepsilon_i \int_0^t \dot{x}_i^2(t) \leq - \sum_{i=1}^m \kappa_i \int_{x_i(0)}^{x_i(t)} \varphi(x_i) dx_i \\ - w(t) + w(0). \end{aligned}$$

Let  $y(t)$  be a bounded solution of system (2). Then  $\varphi(x)$  and  $w(t)$  are bounded. So we have

$$\dot{x}_i(t) \in \mathbf{L}^2[0, +\infty), \quad i = 1, \dots, m.$$

In addition, it follows from the boundness of  $\dot{y}(t)$  and the condition (3) that  $\dot{x}_i(t)$  has a bounded derivative for almost all  $t \geq 0$ . Therefore,  $\dot{x}(t)$  is uniformly continuous. Then one can get

$$\dot{x}(t) \rightarrow 0, \quad \text{as } t \rightarrow \infty. \tag{8}$$

Since the trajectory  $y(t)$  of (2) is bounded, its  $w$ -limit point set  $\Omega$  is nonempty. Then for any trajectory belonging to  $\Omega$  it is true that

$$\dot{x}(t) = 0$$

and consequently

$$x(t) = x_0, \quad x_0 \text{ is a constant vector.}$$

From system (2) we have that for trajectories belonging to  $\Omega$  it is true that

$$Cy(t) + R\varphi(x(t)) = 0, \quad \varphi(x(t)) = \varphi(x_0).$$

Thus for trajectories belonging to  $\Omega$  we have

$$Cy(t) = -R\varphi(x_0) \quad \text{and consequently} \quad C\dot{y}(t) = 0.$$

Combining system (2) we can get the following algebraic equations

$$\begin{aligned} Cy &= -R\varphi(x_0) \\ CAy &= -CB\varphi(x_0) \\ CA^2y &= -CAB\varphi(x_0) \\ \dots &\dots \dots \\ CA^ny &= -CA^{n-1}B\varphi(x_0) \end{aligned} \tag{9}$$

By the observability of  $(A, C)$ , we know that (9) has at most one solution  $y_0$  for given  $\varphi(x_0)$ . And if  $y_0$  is a solution of (9), then we have that

$$Ay_0 + B\varphi(x_0) = 0, \quad \text{i.e. } y_0 = -A^{-1}B\varphi(x_0).$$

Noticing the equilibrium set of (2) is  $\Lambda = \{y_{\text{eq}} | y_{\text{eq}} = -A^{-1}B\varphi(x_{\text{eq}})\}$ . Therefore  $\Lambda = \Omega$ . Then according to (8), we have that every bounded solution of (2) tends to  $\Lambda$  as  $t \rightarrow +\infty$ . In addition (2) has isolated equilibria, so every bounded solution tends to a certain equilibrium of (2). ■

*Remark 1.* The method in [Leonov et al., 1996a] is used repeatedly in Theorem 1. We should point out that the form of system (2) is different from the system form given in [Leonov et al., 1996a]. Especially,  $K(0) = 0$  in system (2). In [Leonov et al., 1996a],  $K(0) \neq 0$  is required generally. In addition, from the proof of Theorem 1 one can see that if the equilibria of (2) are not isolated, one can only get that system (2) is quasi-dichotomous.

**Corollary 1.** *In Theorem 1, if the frequency-domain inequality holds with  $\tau = 0$ , i.e. there exist  $\varepsilon = \text{diag}(\varepsilon_1, \dots, \varepsilon_m) > 0$ ,  $\kappa = \text{diag}(\kappa_1, \dots, \kappa_m)$  such that*

$$\text{Re}\{\kappa K(jw)\} + K^*(jw)\varepsilon K(jw) \leq 0, \quad \forall w \in \mathbf{R}, \tag{10}$$

*then obviously the conclusion in Theorem 1 still holds.*

By KYP Lemma, one can also express the condition (10) in the form of linear matrix inequalities.

**Corollary 2.** *(10) holds if and only if there exists  $P = P^*$  such that*

$$\begin{aligned} &\begin{pmatrix} C^*\varepsilon C & \frac{1}{2}C^*\kappa + C^*\varepsilon R \\ \frac{1}{2}\kappa C + R^*\varepsilon C & R^*\varepsilon R + \text{Re}\{\kappa R\} \end{pmatrix} \\ &+ \begin{pmatrix} PA + A^*P & PB \\ B^*P & 0 \end{pmatrix} \leq 0. \end{aligned} \tag{11}$$

### 4. Nonlinear Interconnections

MIMO system (2) can also be viewed as an interconnected system composed of  $m$  SISO subsystems through some linear interconnections. In what follows, we present a class of input and output nonlinear intercross and consider the effects of this kind of interconnections in (2).

Let  $T$  be an  $m \times m$  permutation matrix (obtained by exchanging the columns of unit matrix  $I_m$ ), and

$$(i_1, \dots, i_m)^* = T(1, \dots, m)^*, \tag{12}$$

$$\psi_T(x) = (\varphi_1(x_{i_1}), \dots, \varphi_m(x_{i_m}))^*.$$

substituting  $\varphi(x)$  in (2) by  $\psi_T(x)$ , one can get a new interconnected system

$$\begin{cases} \frac{dy}{dt} = Ay + B\psi_T(x), \\ \frac{dx}{dt} = Cy + R\psi_T(x), \end{cases} \tag{13}$$

where  $A, B, C, R$  are given as in (2).

According to Theorem 1, one can get the following result for (13).

**Theorem 2.** *Suppose that  $A$  has no pure imaginary eigenvalues,  $(A, B)$  is controllable and  $(A, C)$  is observable. System (13) has isolated equilibria. If (3) holds and there exist diagonal matrices  $\kappa = \text{diag}(\kappa_1, \dots, \kappa_m)$ ,  $\tau = \text{diag}(\tau_1, \dots, \tau_m)$ ,*

$\varepsilon = \text{diag}(\varepsilon_1, \dots, \varepsilon_m)$  with  $\varepsilon > 0$ ,  $\tau \geq 0$  such that the following holds:

$$\begin{aligned} & \text{Re}\{\kappa TK(iw) + K^*(iw)\varepsilon K(iw) - [\mu_1 TK(iw) \\ & - iwI]^* \tau [\mu_2 TK(iw) - iwI]\} \leq 0, \quad \forall w \in \mathbf{R}. \end{aligned} \tag{14}$$

Then system (13) is dichotomous.

*Proof.* Just like in the proof of Theorem 1, we consider the system

$$\frac{dz(t)}{dt} = Qz(t) + L\xi(t), \quad \frac{dx(t)}{dt} = D^*z(t), \quad t \geq 0, \tag{15}$$

where  $\xi(t) = d\psi_T(x(t))/dt$ ,  $Q, L, D$  are matrices given as in (5). It is obvious that any solution of system (13) satisfies the system (15). Then let us consider the Hermitian form

$$\begin{aligned} \mathcal{G}(z, \xi) = & \text{Re}\{z^* D \varepsilon D^* z + z^* L \kappa T D^* z \\ & + (\mu_1 T D^* z - \xi)^* \tau (\xi - \mu_2 T D^* z)\} \end{aligned}$$

and the quadratic form

$$\begin{aligned} G(z, \xi) = & 2z^* H(Qz + L\xi) + z^* D \varepsilon D^* z + z^* L \kappa T D^* z \\ & + (\mu_1 T D^* z - \xi)^* \tau (\xi - \mu_2 T D^* z) \end{aligned}$$

for  $y \in \mathbf{R}^{n+m}$ ,  $\xi \in \mathbf{R}^m$ , where  $H$  is a certain Hermitian matrix. Obviously for all complex numbers  $p \neq 0$  which do not coincide with eigenvalues of  $A$  the following equality is valid

$$\begin{aligned} & \mathcal{G}((pI - Q)^{-1} L\xi, \xi) \\ & = |p|^{-2} \xi^* \text{Re}\{\kappa TK(p) + K^*(p)\varepsilon K(p) - (\mu_1 TK(p) \\ & - pI)^* \tau (\mu_2 TK(p) - pI)\} \xi, \quad \forall \xi \in \mathbf{C}^m. \end{aligned}$$

In virtue of condition (14) we have that

$$\mathcal{G}((iwI - Q)^{-1} L\xi, \xi) \leq 0, \quad \forall \xi \in \mathbf{C}^m, \quad w \neq 0. \tag{16}$$

Therefore, it follows from Lemma 1 that there exists a symmetric real matrix  $H$  such that

$$\begin{aligned} & 2 \text{Re}\{z^* H(Qy + L\xi)\} + \mathcal{G}(z, \xi) \leq 0, \\ & \forall z \in \mathbf{R}^{n+m}, \quad \xi \in \mathbf{R}^m. \end{aligned} \tag{17}$$

Let  $w(t) = z^*(t)Hz(t)$ . By (3) and (17), along system (15) we have

$$\dot{w}(t) + \psi_T^*(x(t))\kappa T \dot{x}(t) + \dot{x}^*(t)\varepsilon \dot{x}(t) \leq 0.$$

Integrating the two sides of the inequality above, one gets

$$\begin{aligned} \sum_{i=1}^m \varepsilon_i \int_0^t \dot{x}_i^2(t) \leq & - \sum_{i=1}^m \kappa_i \int_{x_i(0)}^{x_i(t)} \varphi(x_i) dx_i \\ & - w(t) + w(0). \end{aligned}$$

Then similarly as Theorem 1, we know that system (13) is dichotomous. ■

*Remark 2.* Obviously, the effects of the input and output intercross in (13) are shown through a permutation matrix. The number of all permutations in the form (12) is  $m!$  That is, the number of nonlinear combinations in system (2) is  $m!$  Theorem 1 can be viewed as a special case of Theorem 2. The corresponding corollaries similar to Corollaries 1 and 2 can be given for system (13).

*Remark 3.* Of course, system (13) can also be viewed as

$$\begin{cases} \frac{dy}{dt} = Ay + BTT^*\psi_T(x), \\ \frac{dx}{dt} = Cy + RTT^*\psi_T(x), \end{cases} \tag{18}$$

where  $T^*\psi_T(x) = (\varphi_{k_1}(x_1), \dots, \varphi_{k_m}(x_m))^*$ ,  $(k_1, \dots, k_m) = T^*(1, \dots, m)^*$ ,  $T$  is the permutation matrix given in (12). The differences between (18) and (2) are clear. (18) can be viewed as a new system generated by (2) through some column permutations of  $B, R$  and some corresponding interchanges of nonlinear functions (noticing that column permutation does not change the controllability).

In the following we see some resulting changes by the permutation  $T$  given in (12) through an example.

**Example 1.** In order to test the effects of nonlinear interconnections, we consider the following system

$$\frac{dy}{dt} = Ay + B\varphi(x), \tag{19}$$

where

$$A = \begin{pmatrix} -0.004 & 0.03 & 0.5 & 0 \\ 0.03 & 0.003 & 0 & 0.7 \\ 0.05 & 0 & -5 & 3 \\ 0 & 0.01 & -3 & 1 \end{pmatrix}, \quad B = \begin{pmatrix} -0.4 & 3 \\ 3 & 0.3 \\ 5 & 0 \\ 0 & 1 \end{pmatrix},$$

$$y = \begin{pmatrix} y_1 \\ y_2 \\ y_3 \\ y_4 \end{pmatrix}, \quad x = \begin{pmatrix} x_1 \\ x_2 \end{pmatrix} = \begin{pmatrix} y_1 \\ y_2 \end{pmatrix},$$

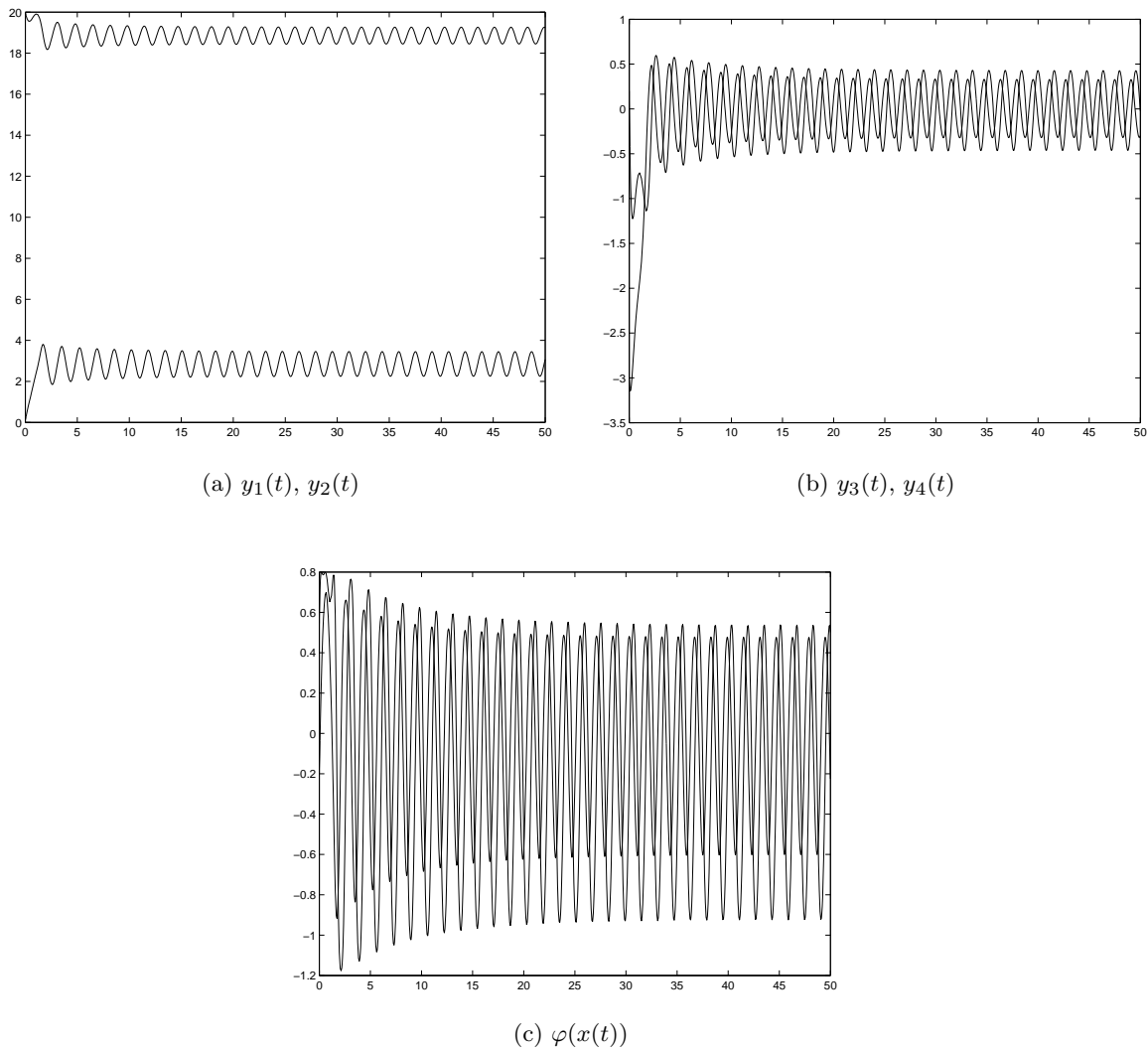

Fig. 1. The solution of (19) with initial value  $y(0) = [0.1, 20, 0.2, -3]^*$ .

$\varphi(x) = (\varphi_1(x_1) \ \varphi_2(x_2))^*$ ,  $\varphi_1(\tau) = \sin(\tau) - 0.3$ ,  $\varphi_2(\tau) = \sin(2\tau) - 0.2$ . It is easy to test that the frequency domain condition in Theorem 1 for system (19) is broken. Refer to Fig. 1 for the bounded oscillating solution of system (19) with some given initial value.

If we substitute  $\varphi(x)$  in (19) by  $\psi(x) = (\varphi_1(x_2) \ \varphi_2(x_1))^*$  and get the following system

$$\frac{dy}{dt} = Ay + B\psi(x), \tag{20}$$

where  $A$  and  $B$  are as given in (19). The conditions in Theorem 2 for system (20) are satisfied. Especially, the frequency domain inequality in Theorem 2 holds with  $\varepsilon = \text{diag}(0.0001, 0.0001)$ ,  $\kappa = -\text{diag}(100, 100)$ ,  $\tau = 0$ . Therefore, system (20)

is dichotomous. Refer to Fig. 2 for the solution of system (20) with the same initial value as given above.

Compare Figs. 1 and 2, one can see that a bounded oscillating solution becomes a convergent solution after input and output interchange. So the difference is clear between Theorems 1 and 2. The input and output interconnections given in the form (12) can result in some great changes in nonlinear systems.

*Remark 4.* Usually, one considers sector nonlinearities, e.g. the systems studied in [Popov, 1973] and [Suykens et al., 1997a, 1998]. Sector conditions are not required in this paper, so the results here are more generally applicable. For example, nonlinear functions are not sector nonlinearities in the

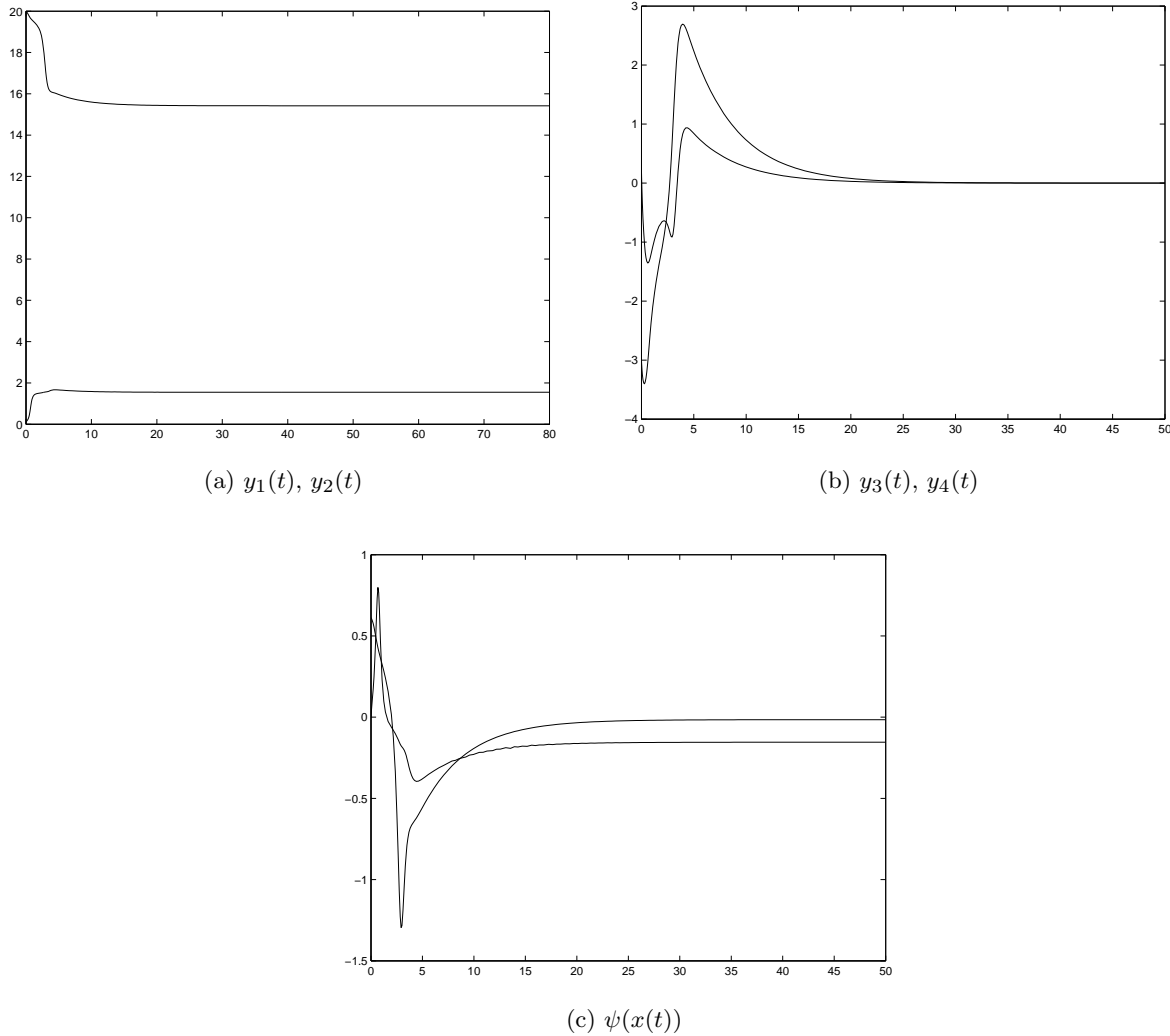

Fig. 2. The solution of (20) with initial value  $y(0) = [0.1, 20, 0.2, -3]^*$ .

example above. Many systems such as Chua’s circuit and coupled Chua’s circuit can be written in Lur’e form [Suykens *et al.*, 1997a, 1998]. In what follows, we analyze Chua’s circuit by using the results given in this paper.

### 5. Chua’s Circuit

In this section, we take Chua’s circuit as an example to clarify the differences between the definitions of dichotomy, quasi-dichotomy and the traditional concept of global stability. Consider the following Chua’s circuit

$$\begin{aligned}
 \dot{x}_1 &= -\alpha x_1 + \alpha x_2 - \alpha f(x_1) \\
 \dot{x}_2 &= x_1 - x_2 + x_3 \\
 \dot{x}_3 &= -\beta x_2 - \gamma x_3
 \end{aligned}
 \tag{21}$$

where  $f(x) = b_0 x + 0.5(a_0 - b_0)(|x + 1| - |x - 1|)$ . The Chua’s circuit as above was also studied in [Leonov *et al.*, 1996a; Suykens *et al.*, 1997a, 1998]. It can be represented as Lur’e form with sector nonlinear function. By combining with the traditional method for Lur’e system and Kalman conjecture for three-dimensional system, it is pointed out in [Leonov *et al.*, 1996a] that system (21) is globally asymptotically stable when  $a_0, b_0, \alpha, \beta, \gamma$  are positive numbers. For example, take  $a_0 = 0.5, b_0 = 3, \alpha = 0.1, \beta = 0.1; \gamma = 1$ , system (21) is globally asymptotically stable. Refer to Fig. 3 for the solutions of (21) at two initial values.

In addition, system (21) can be viewed as a single-input single-output system with the form (2). So it is a special case of (2). Take  $b_0 = -3,$

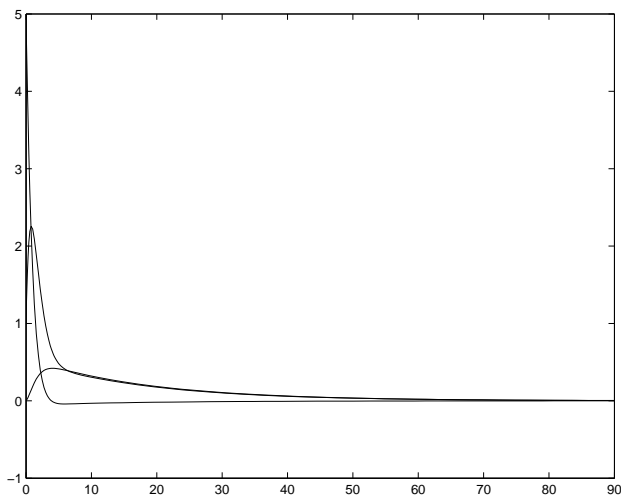

(a)  $x_1(t), x_2(t), x_3(t)$

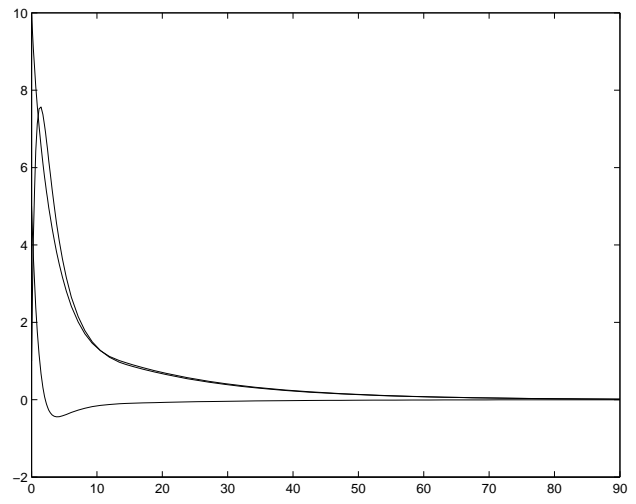

(b)  $x_1(t), x_2(t), x_3(t)$

Fig. 3. The solutions of (21) with initial values  $x(0) = (0, 1, 5)^*$  and  $x(0) = (10, 1, 5)^*$ .

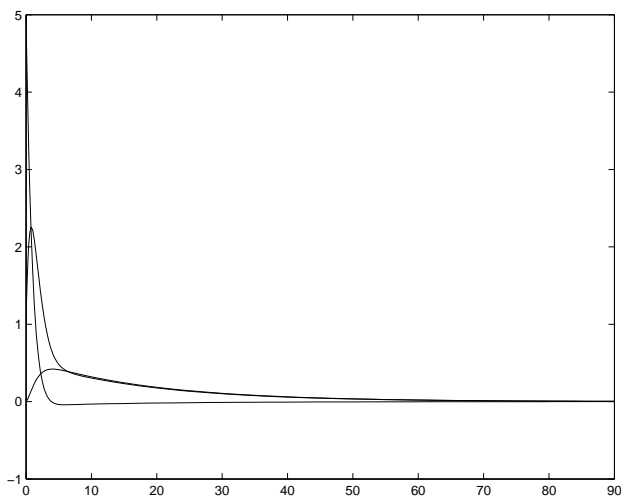

(a)  $x_1(t), x_2(t), x_3(t)$

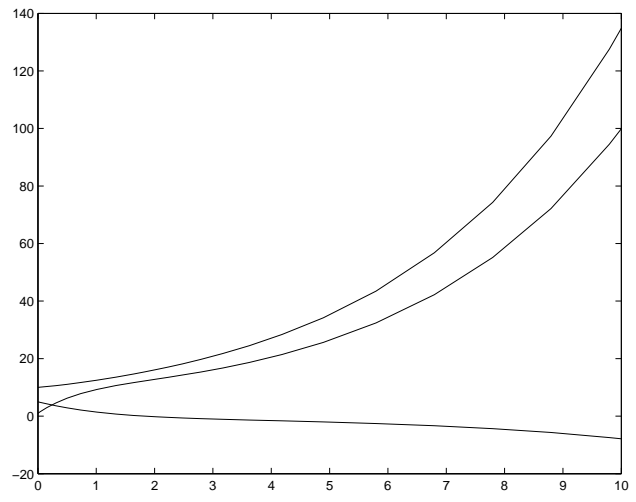

(b)  $x_1(t), x_2(t), x_3(t)$

Fig. 4. The solutions of (21)( $b_0 = -3$ ) with initial values  $x(0) = (0, 1, 5)^*$  and  $x(0) = (10, 1, 5)^*$ .

the other parameters are as given above. At this time, the conditions in Theorem 1 are satisfied for system (21), especially, the frequency-domain inequality holds with  $\tau = 0$ . So system (21) is dichotomous. Refer to Fig. 4 for the solutions at the same initial values as given above.

Compare Figs. 3 and 4, one can see the difference between global stability and dichotomy of system (21) with different values of parameter  $b_0$ . For dichotomous systems, bounded solutions are

convergent, but it is possible that there exist unbounded solutions. The existence of bounded oscillating phenomena is impossible. Of course, global stable systems are dichotomous.

In what follows, we see the phenomenon of quasi-dichotomy. For system (21), we take  $\alpha = 0.08$ ,  $\beta = -0.1$ ;  $\gamma = 0.2$ ,  $a_0 = -\beta/(\beta + \gamma)$ ,  $b_0 = 2.45$ . At this time, the controllability, observability conditions and the frequency-domain inequality with  $\tau = 0$  in Theorem 1 hold for system (21). But there



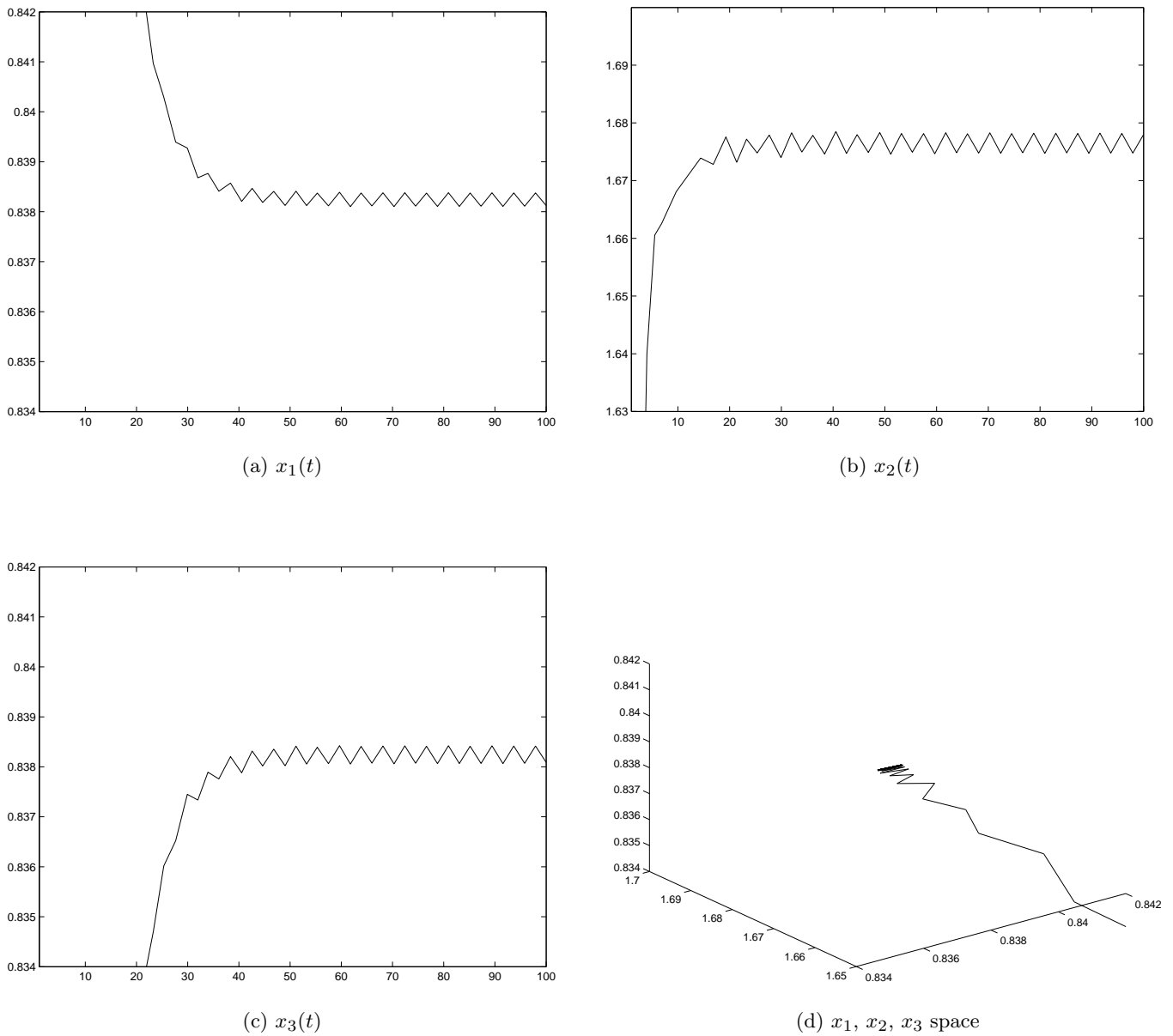

Fig. 5. The property of quasi-dichotomy of (21) with infinite equilibria.

are infinite equilibria for (21) and the equilibria are not isolated. The set of equilibria is

$$\Lambda = \{(x_{1eq}, x_{2eq}, x_{3eq}) | x_{2eq} = \gamma x_{1eq} / (\gamma + \beta), x_{3eq} = -\beta x_{1eq} / (\gamma + \beta), x_{1eq} \in [-1, 1]\}.$$

According to the proof of Theorem 1, system (21) is quasi-dichotomous. All bounded solutions are convergent to the set of equilibria. Now it is possible for the existence of certain bounded solution which is oscillating slightly in the set of equilibria, see

Fig. 5 for the solution of (21) at the initial value  $x(0) = (1.2, -0.3, 0.8)^*$ .

### 6. Interconnected Chua's Circuits

In this section we continue the study on interconnected Chua's circuits with the theorems given in last sections. Consider two Chua's circuits, their differential equations are given as

$$v_1(t) = A_1 v_1 + B_1 f_1(v_{11}) \tag{22}$$

$$v_2(t) = A_2 v_2 + B_2 f_2(v_{21}), \tag{23}$$

where

$$A_1 = \begin{pmatrix} \frac{-1}{C_{11}R_{12}} & \frac{1}{C_{11}R_{12}} & 0 \\ \frac{1}{C_{12}R_{12}} & \frac{-1}{C_{12}R_{12}} & \frac{1}{C_{12}} \\ 0 & \frac{-1}{L_1} & \frac{-R_{11}}{L_1} \end{pmatrix}, \quad A_2 = \begin{pmatrix} \frac{-1}{C_{21}R_{22}} & \frac{1}{C_{21}R_{22}} & 0 \\ \frac{1}{C_{22}R_{22}} & \frac{-1}{C_{22}R_{22}} & \frac{1}{C_{22}} \\ 0 & \frac{-1}{L_2} & \frac{-R_{21}}{L_2} \end{pmatrix},$$

$$B_1 = \begin{pmatrix} \frac{-1}{C_{11}} \\ 0 \\ 0 \end{pmatrix}, \quad B_2 = \begin{pmatrix} \frac{-1}{C_{21}} \\ 0 \\ 0 \end{pmatrix}, \quad v_1 = \begin{pmatrix} v_{11} \\ v_{12} \\ i_{13} \end{pmatrix}, \quad v_2 = \begin{pmatrix} v_{21} \\ v_{22} \\ i_{23} \end{pmatrix}.$$

$f_1$  and  $f_2$  are two nonlinear functions defined as

$$f_1(x) = G_{12}x + 0.5(G_{11} - G_{12})(|x + 1| - |x - 1|), \quad f_2(x) = G_{22}x + 0.5(G_{21} - G_{22})(|x + 1| - |x - 1|).$$

Obviously one can get

$$\min(G_{11}, G_{12}) \leq f'_1(x) \leq \max(G_{11}, G_{12}), \quad \min(G_{21}, G_{22}) \leq f'_2(x) \leq \max(G_{21}, G_{22})$$

when  $f'_1$  and  $f'_2$  exist.

Connect the two Chua's circuits together by a resistor  $R$  as in Fig. 6.

The differential equation of the connecting Chua's circuit is

$$\dot{v} = Av + B(f_1(v_{11}), f_2(v_{21}))^*, \tag{24}$$

where

$$A = \begin{pmatrix} \frac{-1}{C_{11}R_{12}} + \frac{-1}{C_{11}R} & \frac{1}{C_{11}R_{12}} & 0 & \frac{1}{C_{11}R} & 0 & 0 \\ \frac{1}{C_{12}R_{12}} & \frac{-1}{C_{12}R_{12}} & \frac{1}{C_{12}} & 0 & 0 & 0 \\ 0 & \frac{-1}{L_1} & \frac{-R_{11}}{L_1} & 0 & 0 & 0 \\ \frac{1}{C_{21}R} & 0 & 0 & \frac{-1}{C_{21}R_{22}} + \frac{-1}{C_{21}R} & \frac{1}{C_{21}R_{22}} & 0 \\ 0 & 0 & 0 & \frac{1}{C_{22}R_{22}} & \frac{-1}{C_{22}R_{22}} & \frac{1}{C_{22}} \\ 0 & 0 & 0 & 0 & \frac{-1}{L_2} & \frac{-R_{21}}{L_2} \end{pmatrix}, \quad B = \begin{pmatrix} \frac{-1}{C_{11}} & 0 \\ 0 & 0 \\ 0 & 0 \\ 0 & \frac{-1}{C_{21}} \\ 0 & 0 \\ 0 & 0 \end{pmatrix},$$

$v = (v_{11} \ v_{12} \ i_{13} \ v_{21} \ v_{22} \ i_{23})^*$ . Obviously system (24) can be transformed into the form of system (2). Let  $K(p)$  be the transfer function from  $(f_1(v_{11}), f_2(v_{21}))^*$  to  $(dv_{11}/dt, dv_{21}/dt)^*$ . Similarly, let  $K_1(p)$  and  $K_2(p)$  be the transfer functions from  $f(v_{11})$  to  $dv_{11}/dt$  and from  $f(v_{21})$  to  $dv_{21}/dt$ , respectively. Obviously  $K(0) = 0, K_1(0) = 0, K_2(0) = 0$ .

Suppose that  $A_1, A_2$  and  $A$  have no pure imaginary eigenvalues. Obviously the equilibria of systems (22)–(24) satisfy

$$v_{1eq} = -A_1^{-1}B_1f_1(v_{11eq}), \quad v_{2eq} = -A_2^{-1}B_2f_2(v_{21eq}),$$

$$v_{eq} = -A^{-1}B(f_1(v_{11eq}), f_2(v_{21eq}))^*$$

respectively. In the following, we consider the inter-connected Chua's circuit with Theorem 1.

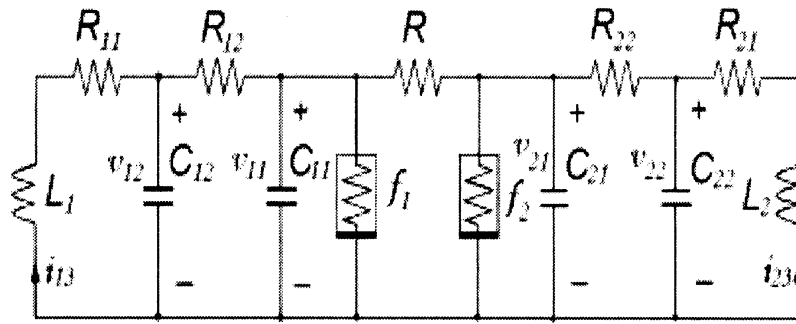
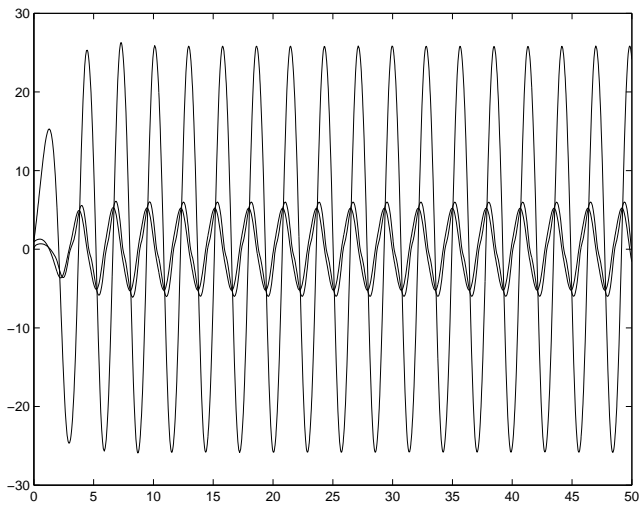
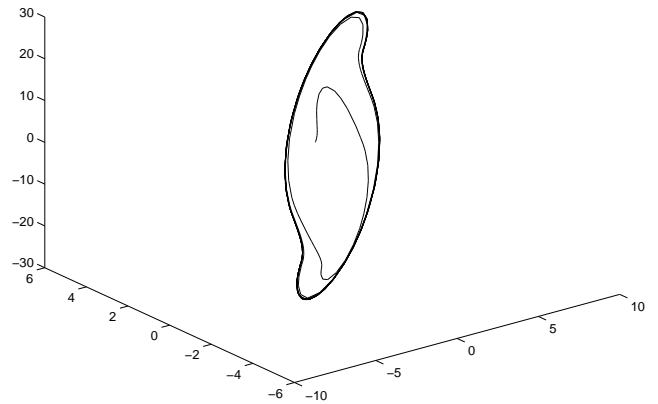

Fig. 6. Interconnected Chua's circuit.



(a)  $v_{11}(t), v_{12}(t), i_{13}(t)$



(b)  $v_{11}, v_{21}, i_{13}$  space

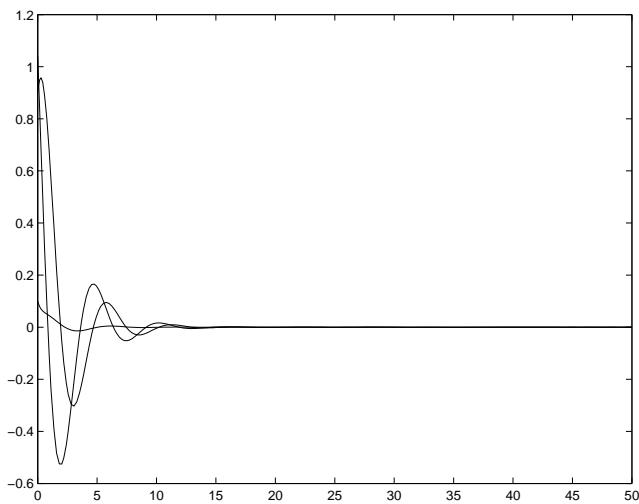

(c)  $v_{21}(t), v_{22}(t), i_{23}(t)$

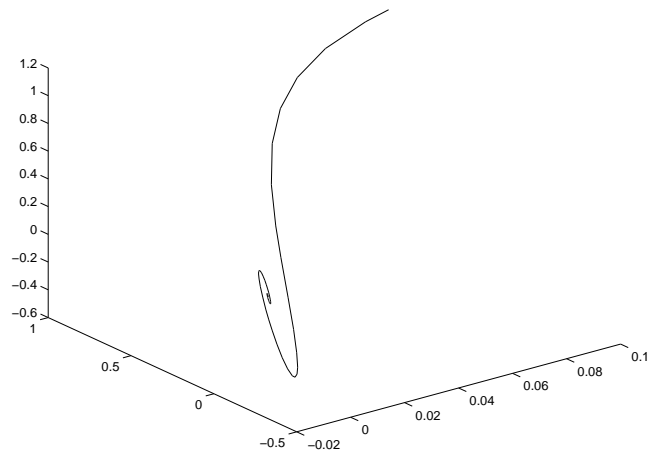

(d)  $v_{21}, v_{22}, i_{23}$  space

Fig. 7. The solutions of (22) and (23) with initial values  $v_1(0) = (0.1, 0.9, 1.042102)^*$ ,  $v_2(0) = (0.1, 0.9, 1.042102)^*$ .

Take parameters  $C_{11} = 2$ ,  $C_{12} = -5$ ,  $R_{11} = -0.001667$ ,  $R_{12} = 0.078884$ ,  $L_1 = -0.08754$ ,  $C_{21} = 5$ ,  $C_{22} = 0.9$ ,  $R_{21} = 0.006667$ ,  $R_{22} = 1.26$ ,  $L_2 = 0.744$ ,  $G_{11} = 10.7$ ,  $G_{12} = -6$ ,  $G_{21} = 14.7$ ,  $G_{22} = 35$ . Testing the conditions in Theorem 1 for systems (22) and (23), we know that system (23) is dichotomous, but the frequency domain condition in Theorem 1 is broken for system (22). Therefore, it is impossible for system (23) existing bounded oscillating solutions. Refer to Fig. 7 for the solutions of (22) and (23) with given initial values.

Then we consider system (24). Two cases can appear with different values of  $R$ .

**Case 1.** Take  $R = 0.1$ , the conditions in Theorem 1 hold for system (24). The frequency inequality holds with  $\varepsilon = 0.00001 \text{diag}(1, 1)$ ,  $\kappa = \text{diag}(0.0038, 0.0038)$ ,  $\tau = \text{diag}(2.4082, 0.9023)$ ,  $\mu_1 = \text{diag}(G_{12}, G_{21})$ ,  $\mu_2 = \text{diag}(G_{11}, G_{22})$ . So system (24) is dichotomous. See Fig. 8 for the solution of (24) with the given initial value.

Compare Figs. 7 and 8, one can see that the bounded oscillating solution and the convergent

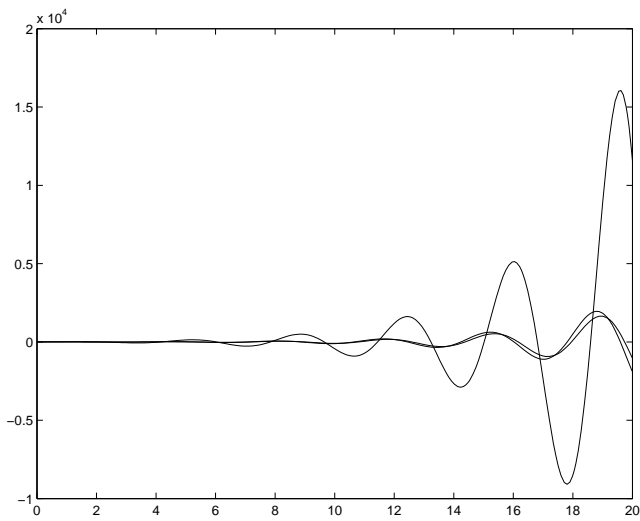

(a)  $v_{11}(t), v_{12}(t), i_{13}(t)$

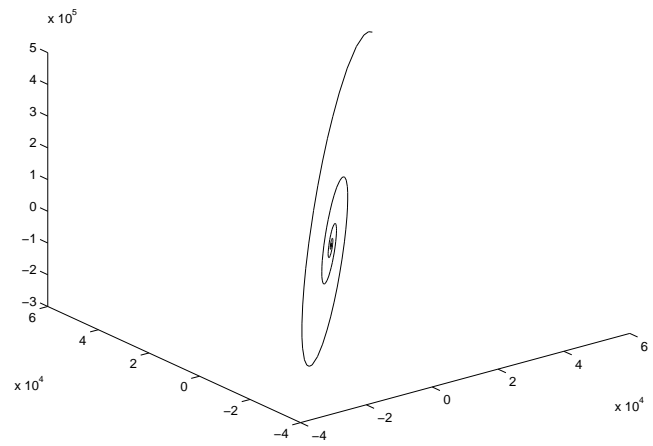

(b)  $v_{11}, v_{12}, i_{13}$  space

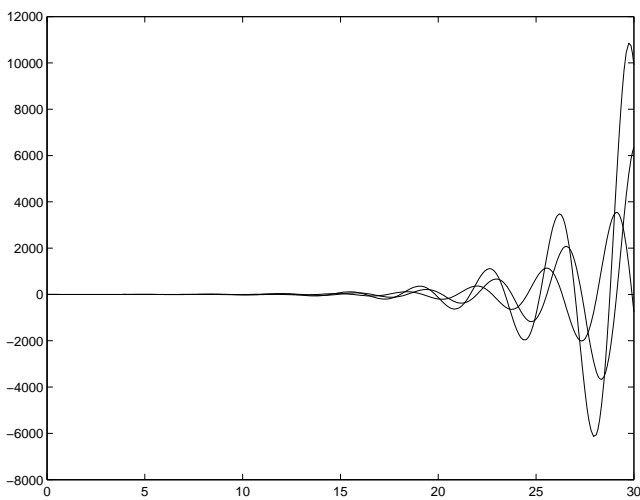

(c)  $v_{21}(t), v_{22}(t), i_{23}(t)$

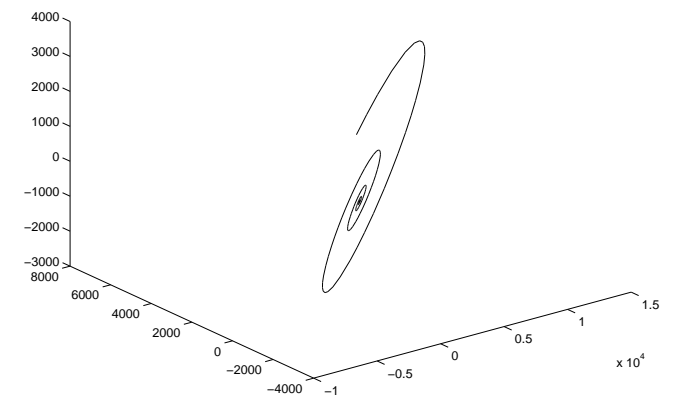

(d)  $v_{21}, v_{22}, i_{23}$  space

Fig. 8. The solution of (24) with initial value  $v(0) = (0.1, 0.9, 1.042102, 0.1, 0.9, 1.042102)^*$ .

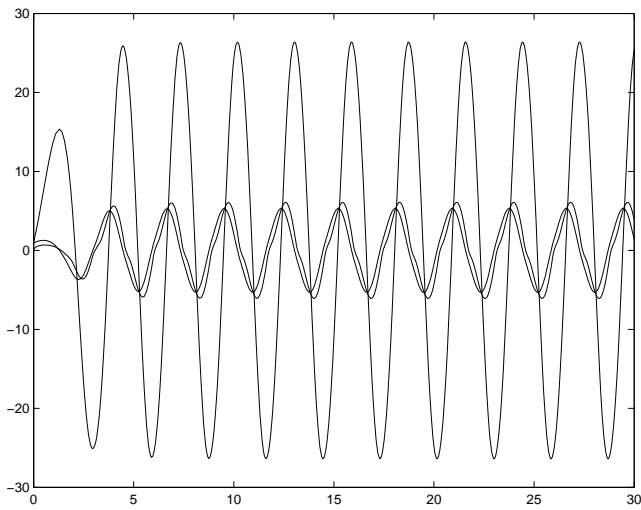

(a)  $v_{11}(t), v_{12}(t), i_{13}(t)$

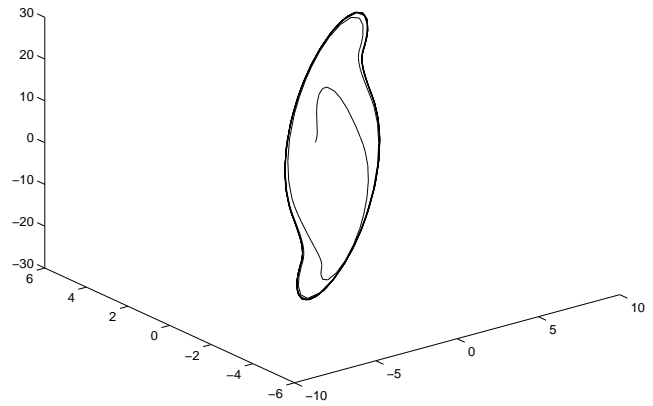

(b)  $v_{11}, v_{12}, i_{13}$  space

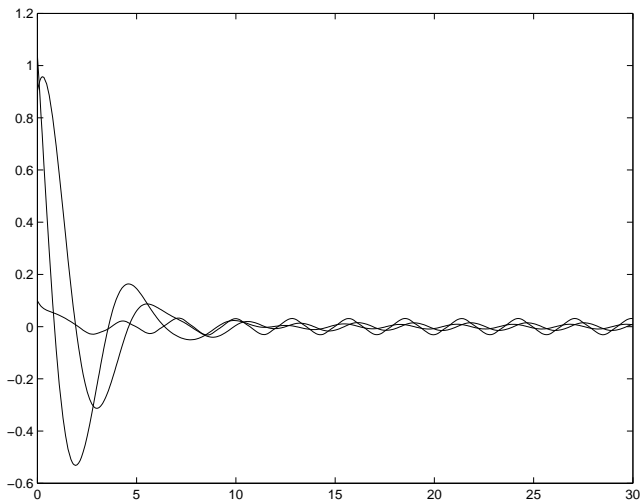

(c)  $v_{21}(t), v_{22}(t), i_{23}(t)$

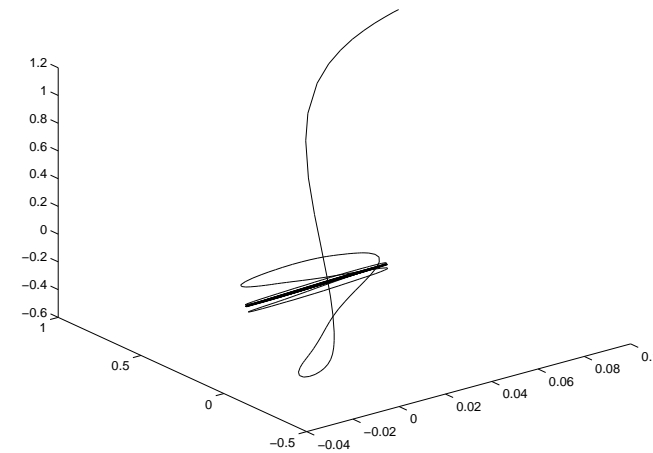

(d)  $v_{21}, v_{22}, i_{23}$  space

Fig. 9. The solution of (24) with initial value  $v(0) = (0.1, 0.9, 1.042102, 0.1, 0.9, 1.042102)^*$ .

solution of single Chua’s circuit become unbounded solution of (24) after interconnection.

**Case 2.** Take  $R = 10$ , in this case the frequency domain inequality in Theorem 1 is broken. See Fig. 9 for the bounded oscillating solution of (24) with the same initial value as given above.

Compare Figs. 8 and 9, one can see that dichotomous system becomes nondichotomous. A bounded oscillating solution appears after changing the value of  $R$ .

Exchanging the nonlinear functions in (24), one can get a new system as follows

$$\dot{v}(t) = Av + B(f_2(v_{11}), f_1(v_{21}))^*, \quad (25)$$

where  $A, B, v, f_1$  and  $f_2$  are given as above. According to Remark 3, obviously system (25) can be viewed as a system with the form of system (13). In fact, for system (25) the frequency domain inequality in Theorem 1 holds with  $\varepsilon = 0.00001 \text{diag}(1, 1)$ ,  $\kappa = \text{diag}(36.77, 36.77)$ ,  $\tau = \text{diag}(0.01849, 0.00059)$ ,  $\mu_1 = \text{diag}(G_{21}, G_{12})$ ,  $\mu_2 = \text{diag}(G_{22}, G_{11})$  ( $\mu_1$  and  $\mu_2$  are different with the Case 1). By testing the other conditions in Theorem 1, we know that system (25) is dichotomous ( $R = 10$ ). See Fig. 10 for the solution of (25) with the same initial value as given in Case (2).

Compare Figs. 9 and 10, one can see that the bounded oscillating solution disappears after the interchange of nonlinear functions.

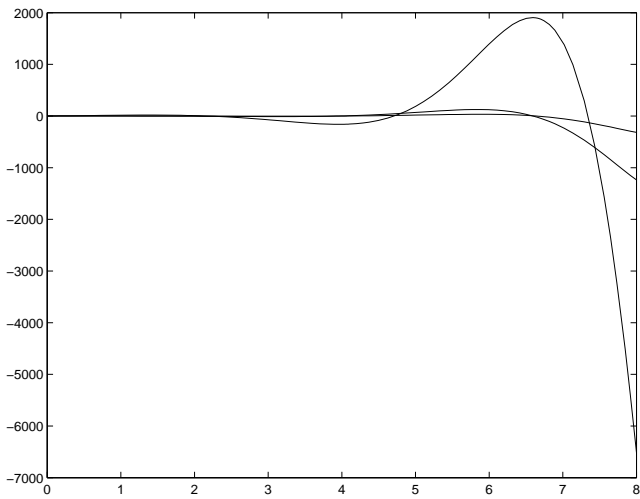

(a)  $v_{11}(t), v_{12}(t), i_{13}(t)$

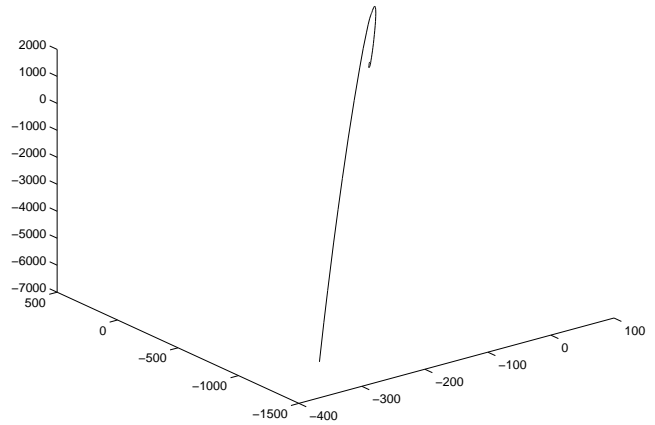

(b)  $v_{11}, v_{12}, i_{13}$  space

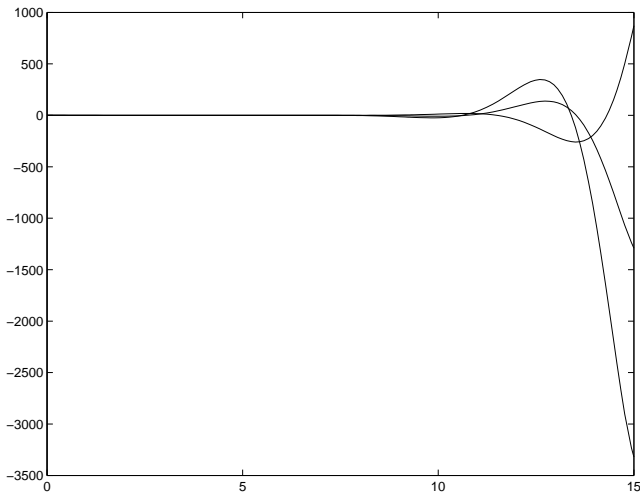

(c)  $v_{21}(t), v_{22}(t), i_{23}(t)$

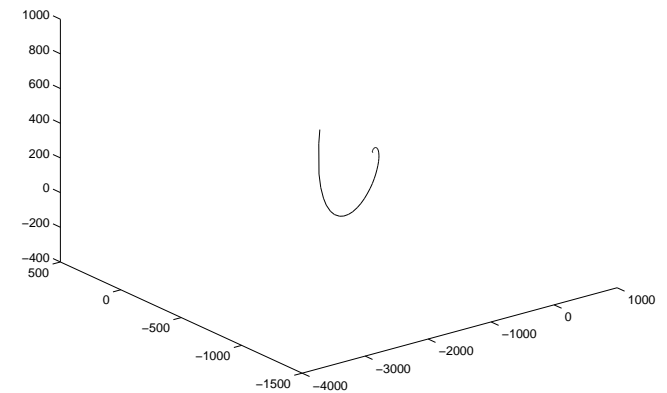

(d)  $v_{21}, v_{22}, i_{23}$  space

Fig. 10. The solution of (24) with initial values  $v(0) = (0.1, 0.9, 1.042102, 0.1, 0.9, 1.042102)^*$ .

### 7. One-Way Coupled Chua's Circuit

Obviously, the method given above can also be used to analyze one-way coupled Chua's circuit as studied in [Kapitaniak *et al.*, 1994; Imai *et al.*, 2002]. For example, consider the following one-way

coupled Chua's circuit,

$$\begin{cases} \dot{v}_1 = A_1 v_1 + b_1 f_1(v_{11}), \\ \dot{v}_2 = A_2 v_2 + A_{21} v_1 + b_2 f_2(v_{21}), \end{cases} \quad (26)$$

where

$$A_1 = \begin{pmatrix} -\frac{1}{C_{11}R_{12}} & \frac{1}{C_{11}R_{12}} & 0 \\ \frac{1}{C_{12}R_{12}} & -\frac{1}{C_{12}R_{12}} & \frac{1}{C_{12}} \\ 0 & -\frac{1}{L_1} & -\frac{R_{11}}{L_1} \end{pmatrix}, \quad b_1 = \begin{pmatrix} -\frac{1}{C_{11}} \\ 0 \\ 0 \end{pmatrix}, \quad v_1 = \begin{pmatrix} v_{11} \\ v_{12} \\ i_{13} \end{pmatrix}, \quad b_2 = \begin{pmatrix} -\frac{1}{C_{21}} \\ 0 \\ 0 \end{pmatrix},$$

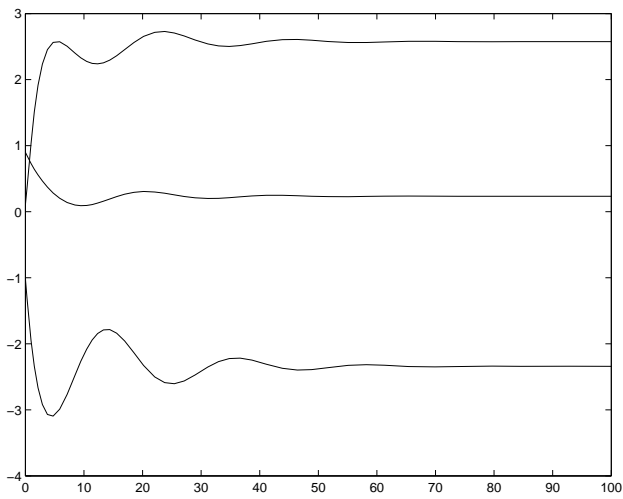

(a)  $v_{11}(t), v_{12}(t), i_{13}(t)$

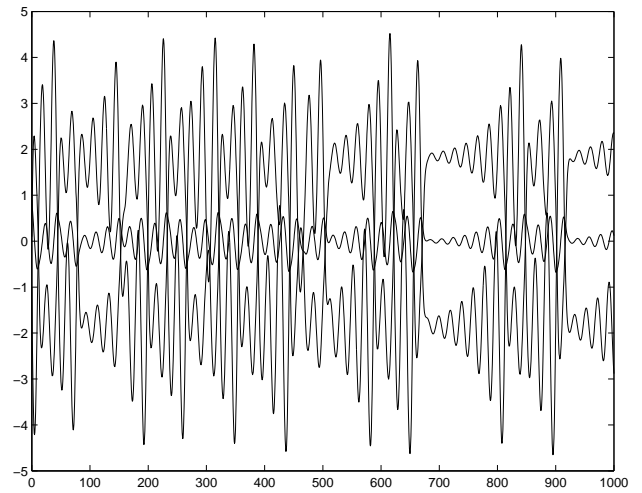

(b)  $v_{21}(t), v_{22}(t), i_{23}(t)$

Fig. 11. The solutions of the two single Chua's circuits in (26) with initial values  $v_1(0) = v_2(0) = [0.1, 0.9, -1]^*$ .

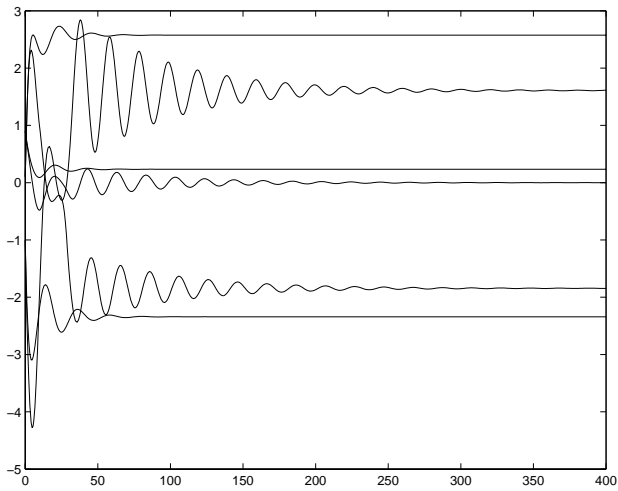

(a)  $v_{11}(t), v_{12}(t), i_{13}(t), v_{21}(t), v_{22}(t), i_{23}(t)$

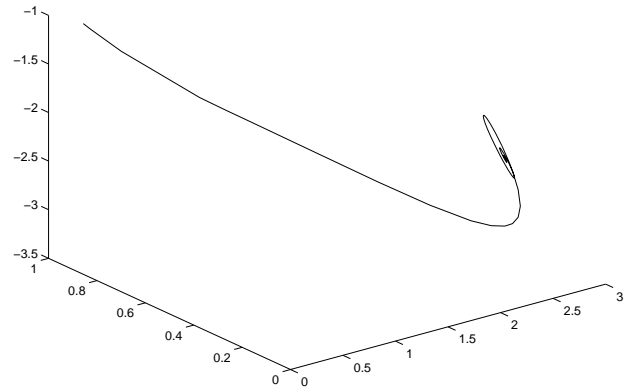

(b)  $v_{11}, v_{12}, i_{13}$  space

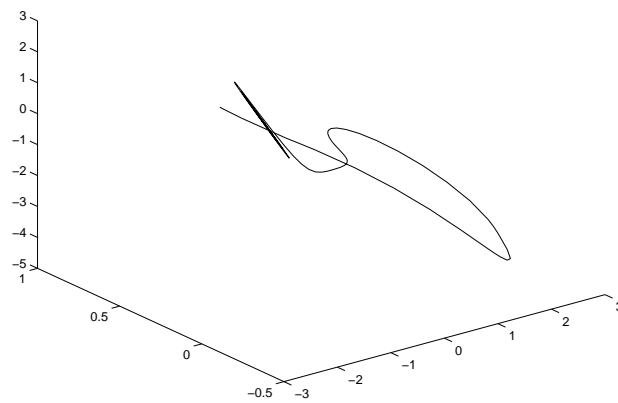

(c)  $v_{21}, v_{22}, i_{23}$  space

Fig. 12. The solution of (26) with initial values  $v(0) = [v_1(0), v_2(0)]^* = [0.1, 0.9, -1, 0.1, 0.9, -1]^*$ .

$$v_2 = \begin{pmatrix} v_{21} \\ v_{22} \\ i_{23} \end{pmatrix}, \quad A_2 = \begin{pmatrix} -\frac{1}{C_{21}R_{22}} & \frac{1}{C_{21}R_{22}} & 0 \\ \frac{1}{C_{22}R_{22}} & -\frac{1}{C_{22}R_{22}} - \frac{1}{C_{22}R} & \frac{1}{C_{22}} \\ 0 & -\frac{1}{L_2} & -\frac{R_{21}}{L_2} \end{pmatrix}, \quad A_{21} = \begin{pmatrix} 0 & 0 & 0 \\ 0 & \frac{1}{C_{22}R} & 0 \\ 0 & 0 & 0 \end{pmatrix}.$$

$R$  is a new resistor which connects two Chua's circuits together.

Take  $C_{11} = 1$ ,  $C_{12} = 10$ ,  $R_{11} = 0.1$ ,  $R_{12} = 1$ ,  $L_1 = 1/1.487$ ;  $C_{21} = 1$ ,  $C_{22} = 10$ ,  $R_{21} = 0$ ,  $R_{22} = 1$ ,  $L_2 = 1/1.487$ ,  $G_{11} = G_{21} = -1.27$ ,  $G_{12} = G_{22} = -0.68$ . Now the conditions in Theorem 1 hold for the first single Chua's circuit in (26). So the first Chua's circuit is dichotomous. And according to the traditional references [Chen & Dong, 1998; Chua et al., 1986], one knows that there is a typical chaotic solution in the second Chua's circuit of (26). Refer to Fig. 11 for the solutions of single Chua's circuits in (26).

After one-way connection as in system (26) by a new resistor  $R = 1$ , let  $K(s)$  be the transfer function from  $(f_1(v_{11}), f_2(v_{21}))^*$  to  $(\dot{v}_{11}, \dot{v}_{21})^*$  in (26). Testing the conditions in Theorem 1 for (26), one knows that system (26) is dichotomous. Especially, the frequency domain inequality holds with  $\tau = 0$ . Refer to Fig. 12 for the solution of (26).

Compare Figs. 11 and 12, one can see that a chaotic solution and a convergent solution of single Chua's circuits generate a convergent solution of (26) after a one-way connection. And it is impossible for (26) existing bounded oscillating solutions.

## 8. Conclusion

This paper is devoted to studying some kinds of interconnected systems. First some criteria of dichotomy for a class of nonlinear systems are presented. Some kinds of nonlinear input and output interconnections are given, and the corresponding criteria of dichotomy are established. The interconnected Chua's circuits are also studied. One can see the acts of interconnections clearly from the examples given in this paper. With the method in this paper, the other kinds of interconnected Chua's circuits can be studied similarly.

## Acknowledgments

This work is supported by the National Science Foundation of China under grants 60204007, 60334030, 10272001.

## References

- Anderson, B. D. O. [1967] "A system theory criterion for positive real matrices," *SIAM J. Contr. Optimiz.* **5**, 171–192.
- Basso, M., Genesio, R. & Tesi, A. [1996] "Frequency domain methods and control of complex dynamics," *Proc. 37th IEEE CDC*, Tampa, Florida, USA.
- Chen, G. & Dong, X. [1998] *From Chaos to Order: Methodologies, Perspectives and Applications* (World Scientific, Singapore).
- Chua, L. O., Komuro, M. & Matsumoto, T. [1986] "The double scroll family, Part I and II," *IEEE Trans. Circuits Syst.* **33**, 1073–1118.
- Chua, L. O. [1994] "Chua's circuit: 10 years later," *Int. J. Circuits Th. Appl.* **22**, 279–306.
- Huang, L. [2003] *Fundamental Theory of Stability and Robustness* (Scientific Publishing House, Beijing) (in Chinese).
- Imai, T., Konishi, K., Kokame, H. & Hirata, K. [2002] "An experimental suppression of spatial instability in one-way open coupled Chua's circuits," *Int. J. Bifurcation and Chaos* **12**, 2897–2905.
- Jorge, L. & Chua, L. O. [1999] "Hopf bifurcation and degeneracies in Chua's circuit — A perspective from a frequency domain approach," *Int. J. Bifurcation and Chaos* **9**, 295–303.
- Kapitaniak, T., Chua, L. O. & Zhong, G. Q. [1994] "Experimental hyperchaos in coupled Chua's circuits," *IEEE Trans. Circuits Syst.-I* **41**, 499–503.
- Leonov, G. A., Ponomarenko, D. V. & Sminova, V. B. [1996a] *Frequency-Domain Method for Nonlinear Analysis: Theory and Applications* (World Scientific, Singapore).
- Leonov, G. A. & Sminova, V. B. [1996b] "Stability and oscillations of solutions of integro-differential equations of pendulum-like systems," *Math. Nachr.* **177**, 157–180.
- Moiola, J. L. & Chen, G. R. [1996] *Hopf Bifurcation Analysis: A Frequency-Domain Method* (World Scientific, Singapore).
- Popov, V. M. [1973] *Hyperstability of Automatic Control Systems* (Springer-Verlag, NY).
- Rantzer, A. [1996] "On the Kalman–Yakubovich–Popov lemma," *Syst. Contr. Lett.* **28**, 7–10.
- Shil'nikov, L. P. [1993] "Chua's circuits: Rigorous results and future problems," *IEEE Trans. Circuits Syst.-I* **40**, 784–786.



- Siljak, D. D. [1978] *Large-Scale Dynamic Systems* (North-Holland, NY).
- Suykens, J. A. K., Curran, P. F., Vandewalle, J. & Chua, L. O. [1997a] "Robust nonlinear  $H_\infty$  synchronization of chaotic Lur'e systems," *IEEE Trans. Circuits Syst.-I* **44**, 891–904.
- Suykens, J. A. K. & Vandewalle, J. [1997b] "Nonlinear  $H_\infty$  synchronization of chaotic Lur'e system," *Int. J. Bifurcation and Chaos* **7**, 1323–1335.
- Suykens, J. A. K., Yang, T. & Chua, L. O. [1998] "Impulsive synchronization of chaotic Lur'e systems by measurement feedback," *Int. J. Bifurcation and Chaos* **8**, 1371–1381.