

Linearization of the sensors characteristics: a review

Tarikul Islam^{1,*} and S. C. Mukhopadhyay²

¹Department of Electrical Engineering, J. M. I. (Central University), New Delhi, 110025, India.

²Macquarie University, Sydney, Australia.

*E-mail: tislam@jmi.ac.in

This paper was edited by Anidya Nag.

Received for publication April 29, 2019.

Abstract

Today, the sensing devices play an important role for various system automation and monitoring of different physical and chemical parameters. Nonlinearity is an important long-time issue for most of the sensors, so to compensate nonlinearity, various linearization schemes are reported in the literature. The accuracy of linearization schemes depends on the type and the nonlinearity value of the sensor output. Since it is difficult to find an exact polynomial equation or other functions to represent the response curve; it gives more error when the measurement parameter is determined from the inverse approximation functions. As many sensors are used for different applications, the linearized characteristics will simplify the design, calibration, and accuracy of the measurement. This paper presents a review of different methods applied to linearize sensor characteristics reported in the literature. Due to availability of high-performance analog devices, analog methods are still popular among many researchers. However, due to the advancement of IC technologies, hardware implementation of the software methods can be done easily with reduced time, cost, and more accuracy, so the digital methods combined with software techniques perform the job with better flexibility and efficiency.

Keywords

Sensors, Nonlinearity, Compensation, Linearization schemes.

The sensor is an important device in instrumentation, measurement, and control applications. It can be used to measure various physical, chemical, and physiological parameters. It plays a very important role in numerous industrial, home, healthcare, defense, environmental, and agricultural applications (Doebelin and Manik, 2011; Silva et al., 2015; Alahi et al., 2016; Islam, 2016; Mahboob et al., 2016; Islam et al., 2017). Various sensors such as (i) capacitive, (ii) resistive, (iii) inductive, (iv) impedance, (v) amperometric (vi) electrochemical, (vii) chemical/biological field effect transistors (ChemFET/BioFET), (viii) surface acoustic wave (SAW), etc. Doebelin and Manik (2011) and Islam et al. (2017) are used for measuring different parameters. Many sensors show a non-linear response with the variation of the measurement

parameters. However, there may be some sensors including some electrochemical sensors, which are linear but for a limited range of measurement (Jafaripanah et al., 2017). It can be linearized to some extent by processing the sensing materials as well as suitably designing the geometrical configuration of the structures. But this is tedious, time-consuming, and difficult to achieve in many cases (Doebelin and Manik, 2011; Alahi et al., 2016; Mahboob et al., 2016).

The response for very thin hydrophilic sensing film based two electrodes parallel plate moisture sensor is quite linear (Islam, 2016; Mahboob et al., 2016). In the study of Silva et al. (2015), several multilayered structures of spintronic materials were engineered to fabricate the magnetoresistive sensors to obtain a

linear response. Many factors such as materials, geometries, and layout strategies are studied to improve the linear response as well as the detection limit of the sensors.

With the availability of advanced fast active devices at low cost, it may be easy to linearize the response by the signal conditioning circuits with relatively small delay (Patranabis et al., 1988; Jafaripannah et al., 2017). Generally, the response of a sensor can be voltage or current, frequency or time signal. In most of the cases, the output signal varies nonlinearly with the variation of input measurement parameters. Also, in many cases, the environmental factors such as temperature, humidity, or pressure affect the sensor characteristics nonlinearly. Sometimes, these environmental factors modify the input-output relation of the sensor (Doebelin and Manik, 2011). These factors are more critical for chemical sensors. A brief review of time-dependent instability of the gas sensors parameters is reported in the study of Korotcenkov and Cho (2011). Figure 1 shows the nonlinear impedance response of a ceramic humidity sensor (Islam et al., 2014a). The desired linear response (Z_{lin}) is also shown in the same graph.

Most of the humidity sensors fabricated using ceramic, or polymer or porous silicon materials have a nonlinear response. A typical nonlinear response curve of a sensor can be represented by n th-order polynomial function, the order of which depends on the nonlinearity value. A typical third-order response (y) can be represented by:

$$y = a_3x^3 + a_2x^2 + a_1x + a_0, \quad (1)$$

where x is the measurement parameter; and a_3 , a_2 , a_1 , and a_0 are the characteristic coefficients of the sensor.

By the linearization circuit, the nonlinear response curve can be approximately linearized. Linearity value can be determined by Doebelin and Manik (2011):

$$L_{non} = \frac{\max(y_n - y_l)}{\max(y_n)}, \quad (2)$$

where y_n and y_l are the actual nonlinear and linearized outputs of the sensor at an input signal; and $\max(y_n)$ is the full span output signal.

The response shown in Figure 1 has ~29% nonlinearity. It is also caused due to inappropriate selection of an electronic circuit. For example, Wheatstone-based impedance bridges are widely employed for developing a readout circuit for the precise measurement of the electrical parameters of the sensors. Inherently

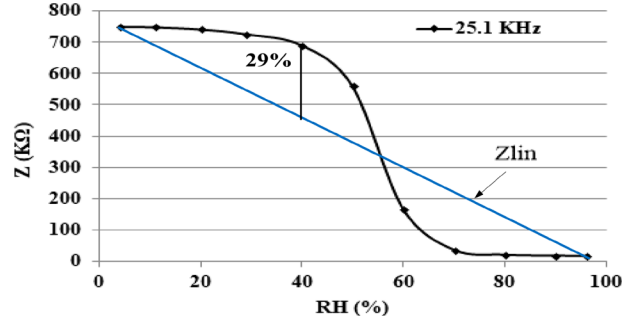

Figure 1: Nonlinear impedance response of a ceramic humidity sensor (Islam et al., 2014a).

linear output voltage with impedance change is only available in case of a fully symmetric full bridge configuration as shown in Figure 2A. The main challenge of this bridge for this linear response is to have an equal and opposite change of the impedance values. This is difficult to design and is a costly solution. $V_0 = (\Delta Z_s / Z_s) V_i = \delta V_i$, impedance sensitivity:

$$\delta = \frac{\Delta Z_s}{Z}. \quad (3)$$

Therefore, for a practical cost-effective solution, the impedance bridges with only increasing or decreasing impedance value are suitable. But such non-symmetrical bridges are inherently nonlinear. The output voltage of the half bridge circuit with CB and AD sensing arms is given by de Graaf and Wolfenbuttel (2006):

$$V_0 = -\frac{\Delta Z_s}{Z_s + (2(Z_s/Z_l) + 1)(Z_s + \Delta Z_s)} V_i. \quad (4)$$

If $Z_l \gg Z_s$, then the expression can be simplified as follows:

$$V_0 = -\frac{\Delta Z_s}{2Z_s + \Delta Z_s} V_i = -\frac{\delta}{2 + \delta} V_i \{-1/\delta\}. \quad (5)$$

The detector output for fixed bridge excitation V_i for different values of δ is shown in Figure 2B. Equation (5) clearly indicates that the output is nonlinear, and for $\delta=0.2$, the nonlinearity value is nearly 9%. The transfer function of such type of bridge configuration is hyperbolic. In Equation (4), the nonlinearity value also depends on the load impedance Z_l . In addition, the value Z_s of any sensor varies nonlinearly with the input measurement

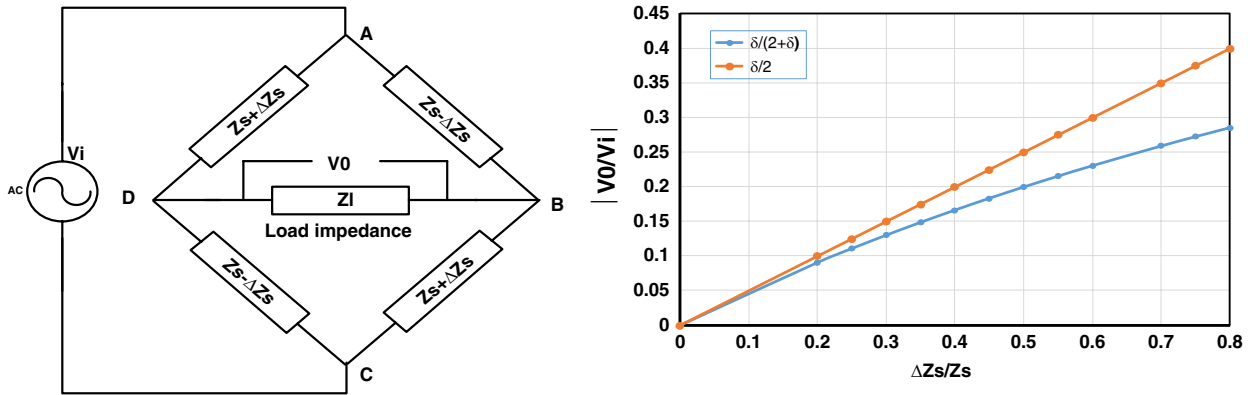

Figure 2: (A) Symmetrical bridge configuration; (B) its transfer curve (de Graaf and Wolffenbuttel, 2006).

parameter as shown in Figure 1. This may introduce more nonlinearity to the output of the bridge circuit.

Therefore, to simplify the design and calibration of a sensor, a linear relationship between input and output is highly desirable. A general block diagram of the linearization unit showing important functional subunits is shown in Figure 3.

By linearization, the nonlinear response curve can be converted into a straight line fit, which simplifies the calibration process. So, the calibration may be performed in the shortest time and at low cost. Hence, it is most convenient rather than to refer a nonlinear calibration curve or to compute from a nonlinear calibration Equations (1) and (2).

Development of signal conditioning circuits to compensate the nonlinearity is a matter of investigations for a long time. Many research articles are reported in the literature to explain compensation techniques. However, to the best of our knowledge, there is hardly any review articles for this purpose. Therefore, the present work reviews the research articles on the techniques of the sensor linearization.

Techniques can be categorized broadly into two groups. These are (i) analog methods of signal conditioning, and (ii) digital methods using software linear algorithms (SLA). This digital method can be further classified into (i) software-based linearization, and (ii) analog and digital mixed signal conditioning circuits. This manuscript first reviews the techniques on analog signal conditioning circuits, and then digital methods are discussed. Finally, the signal conditioning using soft computing techniques such as curve fittings, artificial neural network (ANN), fuzzy logic, neuro-fuzzy logic, etc., are discussed.

Analog linearization of sensor characteristics

Linearization of thermistor response

Thermistors are suited for various industrial and consumer electronics applications. This is because of small size, rugged construction, less sensitive to mechanical shock or vibrations, low cost, low-thermal

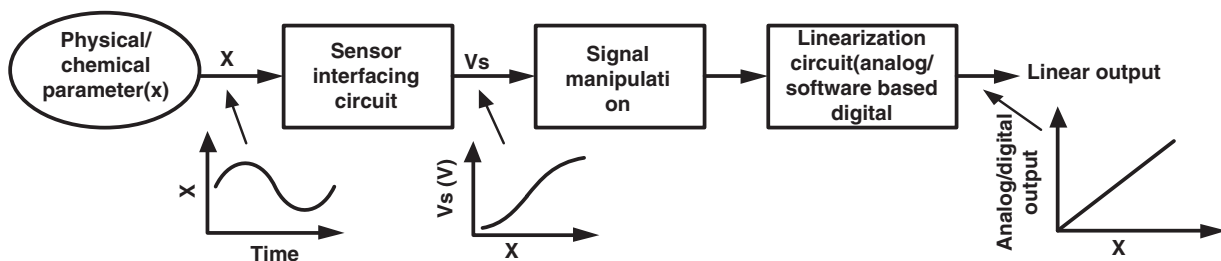

Figure 3: A general block diagram of the linearization unit.

mass, and high sensitivity. A thermistor is also used for the temperature compensation of electronic systems (Nenova and Nenov, 2009). It is also used to study the thermal property of phase change materials (Stanković and Kyriacou, 2012). The main limitation of the thermistor is the limited temperature range and high nonlinearity of the response curve. Many circuits both analog and digital have been developed for compensating the nonlinearity of the thermistor. In many cases, to validate the schemes of linearization, the thermistor response has been used. The nonlinearity of the response is compensated by the series-parallel resistance circuit (SPR) or Wheatstone bridge circuit by optimizing their components values (Nenova and Nenov, 2009). Other methods utilize Op-amp based inverting amplifier circuits (Sarkar et al., 2013).

The third group of methods involves the linear conversion of temperature into frequency or time period of the output signal. Linearization feature of the circuit has been realized by the correct choice of the thermistor parameters and the frequency selective passive components (Kaliyugavaradan et al., 1993; Nenova and Nenov, 2009; Sarkar et al., 2013). In the study of Nenova and Nenov (2009), the thermistor response is linearized by identifying the linear regions and varying the thermistor characteristics parameter (β) using a timer circuit. A one-bit sigma-delta modulator circuit modified with NTC thermistor is used to compensate the thermistor non-linearity (Bandyopadhyay et al., 2016). A timing resistor is appropriately chosen to obtain an approximately linear relation between the time-period of the output pulse train and the ambient temperature. For high precision temperature measurement, a more exact model of the thermistor is suggested in the study of Kaliyugavaradan et al. (1993). Errors due to lead resistance, thermoelectric effect, and amplifier offsets are also studied. In the study of Rudtsch and von Rohden (2015), the authors study the calibration of the thermistor and suggested a more accurate model equation. The interpolation error of the proposed equation is compared with the well-known Steinhart-Hart equation. Table 1 shows the comparison of the thermistor linearization schemes based on accuracy, complexity, and range.

Linearization of thermocouple characteristics

A thermocouple is another important class of temperature sensors for high-temperature measurement for different industrial applications. Thermoelectric effect on which it works is somewhat nonlinear, so the response of TC is nonlinear with temperature variation. Different types of thermocouples having different

measurement range are used but for accurate temperature measurement, nonlinearity and cold junction errors are compensated by various schemes. The response curve of the TC is represented by high-order polynomial function, which is obtained by curve fitting the experimental data. Logarithmic amplifier-based circuits have been reported for the thermocouple linearization and cold junction compensation in the study of Mondal et al. (2009). But, some of the circuits are highly complex to limit them for real-time applications. In some circuits, only simulation results are provided to verify the scheme. Comparison of some linearization schemes of TC characteristic is shown in Table 1.

Linearization of smart diode temperature sensor

Because of high linearity, the diode temperature sensor is fabricated in a chip from (LM35 National semiconductor, AD509 by Analog device, etc.) by several IC manufacturers. Moreover, the nonlinearity of the sensor characteristic is usually compensated by replacing the diode by a bipolar transistor shorting base-collector junction. When the base-emitter voltage is used as an output signal, the exponential characteristic of the base-emitter junction is compensated by the exponential characteristic of the collector current versus the base-emitter voltage. This results in a nice linear behavior. But to maintain linear response, the current flowing through the device should be constant and small less than $100\mu\text{A}$ (Fraden, 2003). With the increase in temperature, the output voltage drops, so the current varies which, in turn, causes some nonlinearity. However, the main drawback of this device is the limited temperature range. In the study of Lucaa et al. (2015), a CMOS smart diode temperature sensor has been used to measure high temperature in the range 80K to 1,080K.

Linearization of RTD temperature sensor

Several works have reported the development of analog signal conditioning circuits for compensating the nonlinearity of metallic alloy resistive sensors, which are popular as a resistance temperature detector (RTD) (Wells, 2011). Resistance versus temperature characteristic for most metallic materials can be represented by high-order polynomial function, the order of which depends on the material, the accuracy, and the temperature range to be measured. For small temperature range from -20°C to 150°C , the platinum RTD is linear within $\pm 0.3\%$ (Doebelin and Manik, 2011). The effect of nonlinearity, self-heating error, and the lead resistance on the RTD temperature

Table 1. Analog schemes of linearization of thermistors, thermocouples, and giant magneto resistive sensors (GMR).

Method	Range	Accuracy (%)	Complexity
(Nenova and Nenov, 2009) Timer-based oscillator circuit	0–120	±1	Low but SPR has low range and low sensitivity
(Stanković and Kyriacou, 2012) Quarter Wheatstone bridge	10–39 0–100	±1.5°C	Low, limited range
Series parallel resistance (SPR)		0.1°C	Low, low sensitivity
(Kaliyugavaradan et al., 1993) Inverting amplifier with thermistor at input	27–113	±1	Low
(Bandyopadhyay et al., 2016) Timer-based oscillator	23–110	0.2°K	High, low reliability
(Fraden, 2003) One-bit sigma–delta modulator	na	±0.01	High, but accurate
(Mondal et al., 2009) Op-amp logarithm amplifier For TC	T: 0–400°C J: 0–760°C	±0.1	Simulation results
(Lucaa et al., 2015) CMOS thermal diode with two driving currents	80–1,080 K	±0.6	High not flexible
(Sanyal et al., 2006) Op Amp based log amp	20–48 m/s	>±0.1 K	Simulation only
(Pappas et al., 2011) Current conveyer	NA	0.84	simulation only
(Bera and Marick, 2012) Diodes-based bridge circuit for flow rate	1–10 Kg/min	0.3	Low
(de Graaf and Wolffenbuttel, 2006) Trans impedance amplifier bridge	±20%	±0.2	Low, simulation only
(Maundy and Gift, 2013) Strain gauge amplifier circuits	na	0.4	Medium
(Bera et al., 2012) Opto-isolator-based analog circuit	na	±1.67	Medium
(Sen et al., 2017) Feedback compensation	0.5–3.5 mT	0.7	Low, GMR inherent nonlinearity
(Jedlicska et al., 2010) Minimizing hysteresis	2.8%	0.74	High, long time, not accurate
(Munoz et al., 2008) Impedance converter as current source for GMR sensor	na	na	High, more drift
(Li and Dixon, 2016) A close loop feedback analog circuit	0–0.3 mT	na	Complex circuit, magnetic sensors
(Chavan and Anoop, 2016) Dual slope ADC (digital output)	0.5–3.5 mT	1.5	Precise resistance, large conversion time
(Sen et al., 2018) Feedback circuit	na	Accuracy not mentioned	Low but magnetic sensor
(Ghallab and Badawy, 2006) Current mode Wheatstone bridge consisting three operational floating current convey	0.5–3.5 mT	0.6	Medium
(Azhari and Kaabi, 2000) Operational floating current conveyer	na	na	High
(Farshidi, 2011) Current mode Wheatstone bridge using CMOS transistor			

sensors are studied in the technical notes of the Texas Instruments. Several analog schemes for the nonlinearity and lead resistance compensation are reported.

Linearization of anemometer flow sensor

Op-amp based two inputs logarithmic circuit, and current conveyer circuit is reported to compensate the nonlinearity of the constant temperature anemometer sensor (Sanyal et al., 2006; Pappas et al., 2011). In the study of Chavan and Anoop (2016), a bridge circuit having four identical p-n junction diodes mounted diametrically across a cross-sectional plane of a pipeline has been used to measure mass flow rate. The response of the circuit has been linearized. But the circuit requires diodes having identical characteristics for better accuracy and linearity. Table 1 shows the comparison of some schemes for the hot wire anemometer.

Non-linearity compensation of GMR sensor

Magnetic field sensing is an important requirement for many industrial applications including speed, position, current, earth magnetic field, and many non-destructive testing and condition monitoring. Among different magnetic sensors, giant magneto-resistive sensor (GMR) draws the attention of the researchers because of its high sensitivity, low power consumption, small size, and low cost. But the main drawbacks of this sensor are the nonlinearity, hysteresis and temperature, and self-heating errors. A typical GMR IC has four identical GMR sensors in the form of the Wheatstone bridge as shown in Figure 2A. Two of the GMR sensors in the two bridge arms (A-D, B-C) are passive, which do not change due to input magnetic field but the resistance of the other two sensors in the bridge arms (A-B and C-D) decreases with the increase in the field. The nonlinearity value of the GMR sensor varies from manufacture to manufacture. A typical AA004 GMR IC from NVE Corporation shows the nonlinearity of nearly 2% (Sen et al., 2017). Therefore, magnetic sensors with linear response, low noise, and improved field detection at low excitation frequency are required for many applications. To compensate the nonlinearity, different techniques such as closed loop feedback, voltage to current converter, look-up table, hysteresis modeling, B spline interpolation, dual slope ADC, and microcontroller-based direct interfacing techniques are reported (Sensirion; Jafaripناه et al., 2005; Kashiwa et al.,

2005; Munoz et al., 2008; Jedlicska et al., 2010; Kumar et al., 2012; Das et al., 2013; Chavan and Anoop, 2016; Li and Dixon, 2016; Sen et al., 2017; Burgués and Marco, 2018; Burgués et al., 2018; Sen et al., 2018). Comparison of some schemes of the GMR sensor is shown in Table 1. Methods are compared based on accuracy, range of measurement, and complexity of the linearization circuits.

Chemo resistive sensor for toxic gas detection

The chemo resistive sensors are another important class of resistive sensors, which are used for air pollutants detection (Korotcenkov and Cho, 2011). The detection limit of the chemical species by the sensors such as metal oxide, field effect, and thermoelectric gas sensors is affected by the nonlinear response of the sensor. Electrical response (R_c) of the metal oxide gas sensor for reducing gas with the variation of concentration (C_g) can be represented by an empirical relation (Fraden, 2003):

$$R_c = KC_g^{-\beta}, \quad (6)$$

where K is the characteristic coefficient of the gas sensing film; and β is the slope of the response curve. For oxidizing gas, the resistance value increases with increase in gas concentration. Additionally, such sensors suffer from cross-sensitivity due to the presence of non-target gases and humidity in the same environment. Estimation of detection limit through linearized calibration models for MOX gas sensor to detect carbon monoxide in the presence of humidity is reported in the study of Burgués et al. (2018). In commercial Figaro gas sensor, the problem of humidity is eliminated by using cyclic high and low voltage pulse applied to the heater. At high voltage pulse, the humidity effect is eliminated, and at low pulse, the sensor is heated at the optimum temperature to obtain the selective response to the target gas. The logarithmic of the output and input best fits the response of the MOX sensors. But for the small range, the response is quasi-linear. So, a logarithmic signal conditioning circuit can be used to linearize the response curve. This work is mainly about the determination of the detection limit using univariate and multivariate linearized modes (Burgués and Marco, 2018). Many other chemical sensors such as potentiometric, amperometric, optical, quartz crystal microbalance, and surface acoustic wave devices also show nonlinear responses.

Piecewise linearization method

Piecewise linearization is one of the simplest and the basic technique of linearization, where the nonlinear response curve is divided into small linear segments. Each linear segment is then implemented by the analog signal conditioning circuits (Sensirion; Jafaripanah et al., 2005; Kashiwa et al., 2005; Doebelin and Manik, 2011; Kumar et al., 2012; Das et al., 2013). For example, the inverse curve of a humidity sensor shown in Figure 4A is divided into two linear segments: (i) 0 to 3% RH range, and (ii) 3 to 10% RH range.

When the voltage signal (V_s) corresponding to a particular %RH is less than 3%, the output will be obtained from the segment 1, otherwise, the output will be obtained from the segment 2. A piecewise linearization circuit having two slopes with V_B as breakpoint implemented using p-n junction diode is shown in Figure 4B. The first slope is formed by the resistances R_s and R_1 , and the second slope is formed by R_s and the parallel combination of R_1 and R_2 (Farshidi, 2011). The approximate linear output response of the circuit scaled to display humidity is shown in Figure 4A.

For better accuracy, the nonlinear response can be divided into more number of linear pieces. But there should be a trade-off between the accuracy and the complexity of the circuit as both the factors increase with the increase in the number of segments (Das et al., 2013). In the study of Jafaripanah et al. (2005), the nonlinearity of a voltage-controlled resistor used in adaptive filter for dynamic compensation of the load cell is piecewise linearized. Important features of the circuit are fast speeds, low power dissipation but the circuit is relatively complex. Very recently, a simple piecewise linear circuit having 2 bits flash ADC, 4X1 multiplexer (MUX), and four analog circuits

are reported (Mahaseth et al., 2018). The ADC and the MUX are used to select one of the linear pieces implemented by op-amp analog circuits. With the help of the combined interfacing and the linearization circuits, the nonlinearity of the capacitive humidity sensor is reduced to less than 1% value. Hardware implementation of the circuit is simple and can be implemented in chip form. The proposed scheme is shown in Figure 5. The nonlinear signal is divided into four approximate linear pieces. This technique can be used to linearize any type of nonlinear response curves such as parabolic, sigmoidal, hyperbolic, etc. (Jedlicska et al., 2010; Alahi et al., 2016; Mahaseth et al., 2018). Slopes of linear segments can be realized by diode circuit (Doebelin and Manik, 2011; Das et al., 2013) or op-amp circuit (Kashiwa et al., 2005). This technique is used to linearize the response of hygroscopic humidity sensors (Jafaripanah et al., 2005; Das et al., 2013), the power amplifier for satellite commutation, nonlinear voltage-controlled FET resistor (Jafaripanah et al., 2005), and single resistive sensor in a current mode Wheatstone bridge (Kashiwa et al., 2005).

Linearization by feedback method

Feasibility of feedback compensation methods using trans-impedance amplifier, Miller theorem, inverse capacitance-based displacement transducers have been explored in many works (Azhari and Kaabi, 2000; Lanyi and Hruskovic, 2001; Ghallab and Badawy, 2006; Farshidi, 2011; Bera et al., 2012; Maundy and Gift, 2013; Sen et al., 2018). The trans-impedance amplifier feedback circuit has been reported for the compensation of single element, multi-element resistive, and capacitive sensors with high accuracy (0.4%) (de Graaf and Wolffenbuttel, 2006). In the study

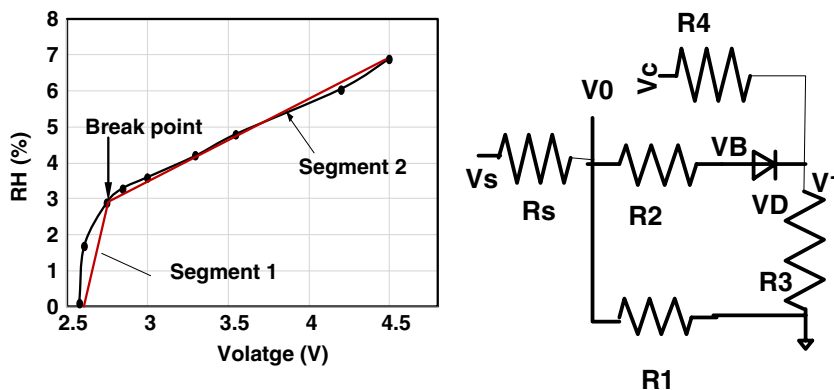

Figure 4: (A) Inverse response of the humidity sensor; (B) linearization circuit.

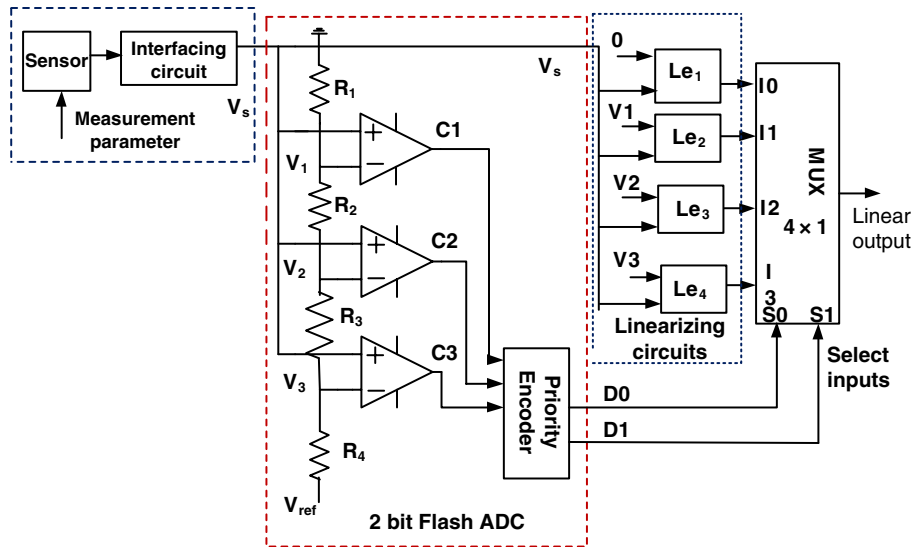

Figure 5: A mixed signal conditioning circuit for piecewise linearization (Mahaseth et al., 2018).

of Bera et al. (2012), an optoisolator based feedback control circuit has been utilized to obtain the linear relation between the thyristor output and the dc input for firing angle control. The accuracy of the scheme is $\pm 0.5\%$. However, the circuit is relatively complex, and errors due to various circuit components are not reported. In another paper, the compensation of the cubic Duffing nonlinearity for MEMS capacitive rate integrating gyroscope (Nitzan et al., 2016) is reported. The accuracy is nearly 2.5%. A circuit comprising of a storage capacitor and a non-linear resistor has been developed in piezoelectricity driven hot electron injector for biomechanical strain measurement (Zhou and Chakrabarty, 2017). Using this technique, the linear injection response has been improved for input power ranging from 5 nW to 1.5 μ W. However, the circuit requires manual selection of values of the compensating capacitor. An accurate (0.1%) signal conditioner IC chip for different errors of the piezo-resistive sensors is reported in the study of MAX1457 (1998). The nonlinear frequency response of an oscillator-based capacitance to frequency converter due to parasitic capacitance for a capacitive tactile sensor is discussed in the study of Constanti (2017). Signal output is linearized by introducing an auxiliary circuit, which behaves as a negative capacitance for neutralizing the parasitic one.

Linearization of the optical sensors

Nowadays, optical sensors are very much useful for measuring various parameters, but these sensors also suffer from nonlinearity. The nonlinearity in homodyne

interferometers is caused by polarization mixing, laser power drift, and imperfection in electronic circuits. It is compensated by fitting the phase quadrature signals of the interferometer using the least square method. It is a time-consuming process; it should be implemented in offline mode (Keem et al., 2005; Kim et al., 2009; Ye et al., 2014, 2015). In the optical encoder, the position is determined with sinusoidal signals using amplitude to phase converter. A highly nonlinear arc-tangent algorithm implemented by a look-up table is used for the computation of the phase angle. To avoid a look-up table, the linearization scheme based on the difference between the absolute values of the sine and cosine signals (Benammar et al., 2005). A linearization method for determining the displacement from sine and cosine signals generated by optical encoders is presented in the study of Benammar (2007). The scheme converts the sinusoidal signals into a nearly triangular signal. Then, the displacement is determined using a linear equation. The position accuracy of 0.2 μ m over the travel length of 80 mm is achieved. A digital signal processing module implemented by FPGA with an accuracy of ± 0.5 nm of the homodyne interferometer has been reported in the study of Kim et al. (2009). The accuracy of the linearization scheme is high, but it is relatively complex. So, it is less reliable and not a cost-effective solution. However, an imperfection in encoder signals due to amplitude imbalance, error in quadrature signals, zero-offset error, harmonic distortion, and amplitude fluctuation introduces nonlinearity. The linearization scheme implemented by FPGA has high speeds high-resolution ADCs, a phase calculation procedure using a look-up

table, a phase checking routine, and an update procedure of parameter for an optical encoder is reported to eliminate some of these errors (Ye et al., 2015). The nonlinearity of the near-infrared (NIR) photo-acoustic signal to detect glucose concentration has been minimized by a dual-wavelength differential method (Tajima et al., 2017). It shows excellent linearity with linear regression correlation coefficient 0.998 over the range from 100mg/dL to 2g/dL. However, the detection limit is not adequate, and the system is relatively complex.

Software-based digital methods of linearization

Due to the advancement of IC chip technology, digital methods nowadays are most commonly used when high performance and high accuracy is demanded. Another advantage of this method is the programmability, which helps to process signals from different sensors. In case of smart sensors, most often analog output signal is converted into binary data. The digital data are then manipulated to have a linear relation. There are two common approaches such as (i) deriving a linear equation, and (ii) look-up table.

Linearization by functional relationship

If the relation between the sensing parameter and the digital data is nonlinear, an equation can be developed to obtain the linearized value of the parameter. For example, the voltage output of a gas sensor is related to ppm gas concentration by Kumar et al. (2012):

$$V_0 = A\sqrt{\text{ppm}}. \quad (7)$$

This voltage signal is converted into the digital variable DV_0 by an ADC. A linear relation between the digital data and the ppm value can be given by:

$$D(\text{ppm}) = \frac{DV_0^2}{A^2}. \quad (8)$$

So, this relation can be obtained by writing a small program stored in the microcontroller memory. The functional relationship depends on the type of the sensor like many semiconducting gas sensors have hyperbolic nonlinearity (Patranabis et al., 1988).

Look-up table method

Simplest digital method is to store a look-up table having a pair of sensor output in digital form and its cor-

responding linear value into the μC memory (Fericean et al., 2009a). This method has been extensively used to compensate the nonlinearity of many sensors including the capacitive sensor. This sensor is used to develop prototype dew point meter for ppm moisture measurement (Islam et al., 2014b). This method suffers from more memory space for better accuracy, otherwise, requires interpolation algorithm in case of fewer data (Bucci et al., 2000; Ghara et al., 2008; Bengtsson, 2012). Some articles have been published to optimize the table to reduce its size for small embedded applications (Bucci et al., 2000; Ghara et al., 2008). In some cases, the look-up table size is optimized by the evolutionary genetic algorithm (Catunda et al., 2003). Another effective method is the use of nonlinear ADC, which provides flexibility and better performance. The digital output of the ADC is the ratio of the input voltage to an arbitrary reference input voltage. In the study of Bucci et al. (2000), a nonlinear programmable ADC having two 3 bits and 11 bits flash ADCs, the input-output characteristic of which is piecewise linear has been proposed. It can be employed to linearize the inverse model of the actual sensor characteristic. Such type of ADC has been utilized to linearize the inverse response of a humidity sensor. However, the hardware circuit is complex for implementation. But the scheme is suitable for VLSI integration for different types of smart sensors. In the interpolation method, the value of an intermediate point between two known given points is determined using a straight-line approximation (Dias Pereira et al., 2007; Bengtsson, 2012). This method offers fast execution speed, less memory requirement, but accuracy depends on the number of segments. A piecewise nonlinear ADC scheme using PWM (Dias Pereira et al., 2007) is proposed. In the study of Sarma and Barua (2010), to improve the accuracy of temperature measurement ($\pm 0.08^\circ\text{C}$), the ninth-order polynomial fitted curve of TC is implemented using a microcontroller-based signal conditioning unit. The circuit is complex to implement and the accuracy depends on the fast and advanced ADC. Few works describing auto-calibrated smart temperature sensor with nonlinearity compensation have been reported in the studies of Chen et al. (2010), Zhang et al. (2014) and Chen and Chen (2016). In such smart sensors, the nonlinearity is compensated by piecewise linearization or parallel compensating oscillator circuit (Zhang et al., 2014), but the range is. Applications of embedded microcontrollers for interfacing and signal conditioning of the sensor's output are discussed in the studies of Sen Gupta and Mukhopadhyay (2010) and Eshrat Alahi et al. (2017). A 2D digital calibration routine for nonlinear transducers is reported in

the studies of López-Martín and Carlosena (2003) and Žorić et al. (2006). A simple chip mixed signal conditioner having multi-sensory interfaces such as voltage, current, capacitive, temperature, programmable signal amplifier, and single bit Δ - Σ ADC with linearized digital output is reported for micro-instrument application (Kraver et al., 2001). Piecewise linearization scheme of thermistor by interpolation in real time is implemented by FPGA or two piecewise ADC with significantly high accuracy (0.3%) (Reverter et al., 2005; Warsito et al., 2014; Lukić and Denić, 2015; López-Lapeña et al., 2016). Several quarter, half, and full bridge circuits are directly interfaced to microcontroller to linearly convert the resistance variation of the sensor into digital form. The circuits are based on measurement of RC time constants to determine the values of the resistance. Important features of the circuits are small hardware components, digital output, and the response is linear. However, the circuits do not compensate nonlinear response of the sensor. Also, similar circuits have also been reported for interfacing capacitive and inductive sensors (Hruskovic, 2001; Reverter et al., 2005; Sreekantan and George, 2014; Lukić and Denić, 2015).

Recently, conventional dual slope analog to digital converter with necessary signal conditioning circuits have been employed to linearize the response of thermistor, Hall effect sensor, and single or double resistive element Wheatstone bridge (Mohan et al., 2008; Mohan et al., 2011; Sreekantan and George, 2014; Ramadoss and George, 2015; Nagarajan et al., 2017). In such schemes, the sensors are the integral parts of the dual slope ADC, which directly converts the sensing parameters into digital form with linearized output. Implementation of the circuits is cost-effective requiring few hardware components and the worst-case measurement error is 0.83%. The execution time of the circuit is dependent on the component value and response delay of a comparator. A relaxation oscillator circuit with quasi-digital output for linearly converting resistance into frequency is discussed in the study of Islam et al. (2013). Some signal conditioning circuits producing quasi-digital linear output for direct interacting to either to PC or microcontroller have been developed recently (Murmu and Munshi, 2018).

Comparison of direct digital interfacing schemes is shown in Table 2. This is to note that if the nonlinear sensor is digitized before its linearization, the ADC will require higher bit resolution than that required for a linearized version of the sensor. On the other hand, a look-up table will fit the linearization requirements only when the memory size required to store the table is moderate. But the size of the look-up table depends on the level of the sensor nonlinearity. A dig-

ital operation can require high computing resources, so that some of the proposed solutions can be more expensive than the sensor itself. The execution time of a linearization scheme may also be an important parameter for certain applications.

This is an important parameter when the sensor is part of a feedback/manual control system, where control action depends on the measured value. Even for monitoring purpose, the response time is important. So, the response of the sensor including a necessary signal conditioning circuit should be fast in many applications. It is true that the response time of many sensors is much larger than the linearization time. For example, most of the gas sensors, which work on adsorption and desorption principle have long response and recovery time and the sensor is also having high nonlinearity (Sanyal et al., 2006). The response time may be several tens of seconds to a minute. To reduce the overall response time of the sensor and the signal conditioning circuit, efforts should be made to design the linearization circuit, which provides low response time. The linearization time can be minimized by judicious selection of electronics devices and reducing hardware components as far as possible.

Soft computing methods of linearization

The software algorithms implemented by the digital system efficiently perform the linearization job with greater efficiency, utility, and flexibility than other methods discussed above. Various software algorithms like spline or polynomial curve fitting techniques, and intelligent soft-computing techniques such as artificial neural networks (ANNs), fuzzy logic, neuro-fuzzy logic, support vector machine, etc., are extensively employed for the purpose of sensor linearization (Daponte and Grimaldi, 1998; Nenov and Ivanov, 2007). A comparative evaluation in terms of reduced calibration points of different polynomial and ANN approximations to measured data is given in the study of Dias Pereira et al. (2001). Polynomials are the most common functions to fit the measured data. A single high-order polynomial function such as Lagrange interpolation can fit the full range response characteristic. The full range is divided into small sub-ranges; each sub-range is then represented by low-order polynomial function like spline interpolation. Some look-up table-based alternative improved methods such as piecewise linear interpolation (PWL), piecewise linear equation (PWLE), and programmable gain amplifier (PGA) has been reported. In PWLE, during linearization, the processor selects one of the equations according to the input value and reads the stored co-

Table 2. Linearization by direct digital linearization and software-based algorithms.

Method	Accuracy/range	Complexity	Applications
(Eshrat Alahi et al., 2017) Non-linear ADC with piecewise linear input-output characteristics	1%,/30 to 90%RH accuracy depends on pieces	Medium	Humidity sensor, smart sensors, flash ADC (3 bit and 11-bit ADCs)
(Žorić et al., 2006) Nonlinear ADC for moisture sensor	na	Medium	Humidity sensor
(Islam et al., 2006; Dias Pereira et al., 2009; Rahili et al., 2012) Direct interface to μ C for half, full Wheatstone bridge	0.3%/0 to 1), 11-bit resolution (10%) (quarter bridge)	Low, lead error, bridge nonlinearity compensation only digital output	Resistive sensors, 8-bit AVR ARDUINO board
(Scheibelhofer et al., 2006) Dual slope ADC for direct interface to μ C with logarithm amplifier	$\pm 0.3^\circ\text{C}$, 0-120 $^\circ\text{C}$	Low, digital output	Thermistor, implementation by LabVIEW
(Fericean et al., 2009b) Feedback compensation scheme	0.03% (100% range)	Low, implementation by analog circuit	Nonlinearity of Wheatstone bridge
(Ramadoss and George, 2015) Microcontroller-based direct interface	0.3% low	digital output, no ADC	Diff. variable inductive sensors
(Nagarajan et al., 2017) Dual slope ADC for direct interface to μ C (quarter/half bridge resistive sensors)	<0.09%, /100%	Digital output, only bridge nonlinearity compensation	resistive sensors, LabVIEW and NI ELVIS-II board, Hall effect sensor
(Sreekantan and George, 2014) Dual slope ADC for direct interface to μ C converter (diff. third order polynomial)	<0.7%	Low, digital output	Differential second- and third-order sensor, tested for inductive sensor
(Islam et al., 2013) Oscillator-based resistance to frequency conversion	<1%	Medium, quasi digital output, frequency conversion temperature error compensation no sensor nonlinearity compensation	Resistive sensors, humidity sensor
(Murmu and Munshi, 2018) Software algorithm for TC	$\pm 1.4\%$, 45-100 $^\circ\text{C}$	High, costly solution	Thermocouple
(Flammini et al., 1997; Flammini et al., 1999; Flammini and Taroni, 1999; Catunda et al., 2003; Erdem, 2010; Islam et al., 2014b) Simple Look-up table for different nonlinear sensors	$\pm 1\%$ moisture, accuracy depends on memory size	Medium	Nonlinear sensors
(Erdem, 2010) Look-up table PWLE for infrared distance sensor. Look-up table_	0.03%	Medium memory than simple Look-up table. Medium, reduced memory.	Nonlinear sensor
PWLI for infrared distance sensor	0.032%		

(Teodorescu) Look-up table PGA	0.023%	Medium, memory Low	nonlinear sensor
(Rivera et al., 2009) Progressive polynomial software method (PPC)for sensors	<1% (max 36%)	Medium, less data points	Resistive nonlinear sensor
(Dias Pereira et al., 2009) Adaptive self-calibration algorithm to determine polynomial equation, based on probability density function	na	Medium, low computation, small memory	Smart sensors air flow sensor
(Rahili et al., 2012) Modified PPC: intelligent selection of calibration points to determine polynomial function	0.83%	Reduced calibration data, small memory locations	Smart sensor nonlinearity for thermistor
(Xinwang et al., 2011) Recursive B-spline least square method	0.01% (6.34%), 0.35% (51% for NTC)	High low data points	Thermocouple NTC Thermistor
(Optimized Sensor Linearization for Thermocouple, 2015) Thermocouple by software algorithm	± 0.02 (-270°C - 1372°C)	Low memory	Thermocouple

efficient in the memory but in the look-up PWLI, the processor after each measurement, determines the linear equation using the stored calibrated data points. The look-up table PGA method basically applies the integrated approaches of a traditional look-up table and PWE/PWLI methods. The PGA has electronic switches and ladder resistance network for digitally selecting the gain of the amplifier. This scheme converts the nonlinear region of the response curve into the linear region by selecting the gain. Since software algorithms implemented by microcontroller/FPGA/PC are a relatively costly solution and consumes more power, so a comparison of some of these algorithms is provided in the study of Erdem (2010). Among the software methods, the progressive polynomial calibration (PPC), which works on the principle that each measurement data are directly utilized to calculate one calibration coefficient in the correction functions. The first measurement is used to correct the offset error, the second data corrects the gain, and all the rest measurements are used for nonlinearity correction (Didenko et al., 2002; Dias Pereira et al., 2009; Rivera et al., 2009; Rahili et al., 2012). Advantages and disadvantages of progressive polynomial calibration (Rivera et al., 2009), free knot recursive B spline (Dias Pereira et al., 2009) are reported in Table 2. This method offers minimum data points, low memory, step by step calibration but suffers from under or overfitting, when nonlinearity is high. It has been utilized to develop an

auto-calibration algorithm with minimum calibration points to compensate offset, gain variation, hysteresis and nonlinearity for thermistor, proximity sensor, microwave, or other magnetoresistive sensors (Didenko et al., 2002; Scheiblhofer et al., 2006; Fericean et al., 2009b; Dias Pereira et al., 2009; Rivera et al., 2009; Rahili et al., 2012). B-spline algorithm for modeling and recursive algorithm for training polynomial inverse function for nonlinearity compensation is reported in the studies of Bluemm et al. (2010) and Xinwang et al. (2011). Some adaptive auto calibration algorithms for smart sensor applications reported in the studies of Dias Pereira et al. (2005) Jordana et al. (2004) and Piao et al. (2017). Iterative techniques provide a partial solution to the complex problem, requires more execution time and more memory space. Comparative performance analysis of six software base linearization algorithms such as piecewise linear interpolation (PWLI), piecewise linear equation (PWLE), traditional look-up table, ANN, and fuzzy logic for low-cost microcontroller implementations are analyzed in detail (Erdem, 2010). Integrated circuit implementation of different piecewise linearization functions is reported in (Di Federico et al. 2010). Experiencing the importance of PWLE, for different signal conditioning applications, an IC chip with three inputs analog, and digital has been realized and successfully tested (Islam et al., 2006). A look-up table design guide for linear interpolation for TC sensor in terms of reduced soft-

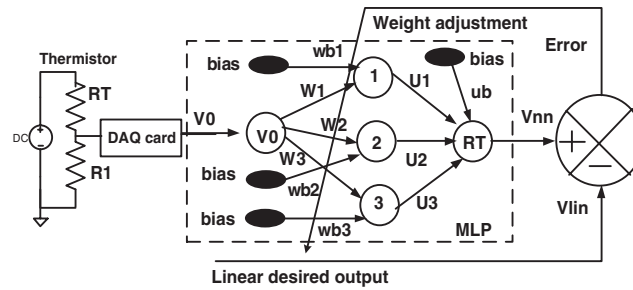

Figure 6: Linearization using multilayer perceptron neural network resistance.

ware complexity and improved accuracy is given in the studies of Flammini and Taroni (1999) and Optimized Sensor Linearization for Thermocouple (2015). A simple, compact low-cost direct to time converter interfacing circuit for different forms of Wheatstone bridge using a microcontroller and associated software algorithm has been reported (Hruskovic, 2001; Sifuentes et al., 2008). But the scheme is applicable for medium range resistance values. Software compensation algorithm for different sources of errors such as ambient temperature, sensitivity drift, and nonlinearity of a piezoelectric gyroscope for fluid flow rate measurement is performed by the digital signal processing device (Islam et al., 2006). The artificial neural network has the ability to process input information like the human brain. It is widely used for measurement applications including instrument calibration, modeling of the sensors, and signal processing units like ADC, DAC. It is also used for the compensation of nonlinearity. Various structures of ANN have been utilized for nonlinearity compensation (Daponte and Grimaldi, 1998; Medrano-Marques et al., 2001; Marconato et al., 2008). A review of ANN-based iterative algorithms for signal processing applications is reported in the study of Meireles et al. (2003). To explain the working of an ANN technique, consider a multilayer perceptron (MLP) based thermistor linearizer as shown in Figure 6. The sensor output V_0 varies nonlinearly with the input temperature. The neural structure consists of an input layer, a hidden layer, and the output layer.

The input to the input layer is the voltage signal V_0 as shown in Figure 6. The hidden layer consists of several hidden nodes, which are nothing but the signal processing units. The inputs to the hidden nodes are the actual nonlinear voltage V_0 and the biases. The outputs of the hidden nodes and the biases are the inputs to the output node. The actual output of the ANN (V_{nn}) is compared with the desired linear output signal V_{lin} . The connecting links between the input

and hidden nodes and the output of the hidden layer and the input to the output node are the weights represented by matrix $[W]$ and $[U]$, respectively.

An MLP with the optimum number of hidden layers and hidden nodes is trained with training data set of $[V_0, V_{lin}]$. This is to note that there will be enough data points for training the MLP. The network is trained with standard training algorithm with suitably selected activation function in the nodes. The ANN output closely matches the desired linear response. The weights $[W, U]$ of the network obtained with minimization of certain error function are utilized to determine the linearized value (V_{nn}) for any temperature within the full-scale range. Some of the important features of this method are (i) an adaptive structure; (ii) an ability to generalization, handle incomplete data, or corrupted data by noise signals; (iii) fault tolerant; (iv) performing simultaneous identical and independent operations; (v) capable of approximating any type of response with arbitrary accuracy. But for a highly nonlinear sensor, more neurons in the hidden layer are required. The iterative ANN technique has computational overload and difficulty of the hardware implementation of nonlinear sigmoidal activation by low-cost microcontroller. Thus, less suitable for low-cost implementation for smart sensor linearization.

Several research articles have reported to compensate nonlinearity, temperature, hysteresis, drift due to aging of various sensors by different ANN structures such as adaptive linear neural network (Islam et al., 2006; Islam and Saha, 2007), multilayer perceptron neural network (Khan et al., 2003; Patra et al., 2008; Khan and Islam, 2011; Kumar et al., 2015; Tarikul Islam et al., 2015), computationally efficient Chebyshev neural network (Patra et al., 2008), Laguerre neural network (LaNN) [137], fully connected cascade (FCC) neural network (Cotton and Wilamowski, 2011), fuzzy logic (Teodorescu), neuro-fuzzy architecture (Bouhedda, 2013), support vector machine (Xiaodong, 2008; Patra et al., 2011), covariance

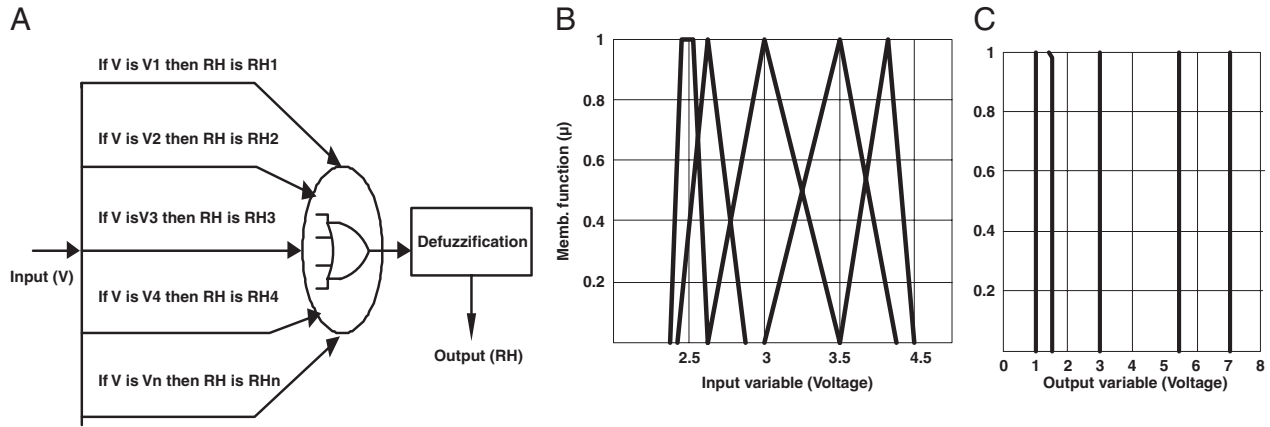

Figure 7: Fuzzy logic-based linearization of the humidity sensor response (4(A)).

Table 3. Fuzzy rules for sensor linearization.

- IF $V < V_1$ (slightly low), then RH is the lowest
- IF $V_1 \leq V < V_2$ (low), then RH is low
- IF $V_2 \leq V < V_3$ (average), then RH is middle
- IF $V_3 \leq V < V_4$ (slightly high), then RH is slightly high
- IF $V_4 \leq V$ (high), then RH is high

matrix-based evolutionary algorithm (Abudhahir and Baskar, 2008). The fuzzy technique is composed of a set of rules that represents the linguistic variables of a function. The set of ‘if-then’ rules maps the input values to the output values as shown in Figure 7A. During mapping, each fuzzy rule defines a fuzzy patch. The inverse input–output nonlinear function of a humidity sensor (RH v/s voltage) can be represented by a fuzzy membership function. A typical triangular membership function for a typical humidity sensor response (Fig. 4) is shown in Figure 7B. Few singletons set of the output variable are shown in Figure 7C. During linearization, this technique accepts the voltage signal as an input variable and determines the linearized humidity as the output variable. Fuzzy rules dividing the voltage level (V) into five ranges according to linguistic variables are shown in Table 3.

Some of the works reported the hardware implementation of the optimized ANN models using a microcontroller, or FPGA (O’Droma and Mgebrishvili, 2005; Islam and Saha, 2007; Patra et al., 2011), or basic analog signal conditioning block. Microcontroller

implementation of any arbitrary trained network is discussed in the study of Cotton and Wilamowski (2011). Fuzzy logic is not efficient for the linearization. It has poor accuracy, requires more memory space, and it takes a long execution time. The signal conditioning by the support vector machine outperforms ANN in terms of generalization, no local minima, no need of prior network topology, confirmed solution, and easy hardware implementation. A brief comparative analysis of different software-based intelligent schemes is shown in Table 4 (Baker, 2005; Lopez-Martin et al., 2013).

Conclusion

This paper reviews the literature on sensor linearization. This is an important issue for real-time applications of the sensing devices. As most of the sensors have a nonlinear response, linear measurement circuits are desired even if the sensor has a linear response. This is because, when a sensor is interfaced to an electronic circuit, it can introduce nonlinearity to the response. Nonlinearity can be reduced to some extent by judicious selection of the input range and processing of the sensing materials. Analog methods of linearization are in general simpler thus still widely used. But some of them are applicable for special types of nonlinearity.

Main limitations of the analog methods are error due to environmental effects, particularly temperature and humidity. These methods also lack flexibility for different kinds of sensors, so accuracy is high typically for the small range.

For online parameters measurement, the cost-effective digital methods with online compensation at high speed and reduced program complexity will be preferred. But the digital methods also suffer from the cross-sensitivities of the environmental effects. How-

Table 4. Linearization by software-based intelligent methods.

Technique	Accuracy	Complexity	Implementation
(Nenov and Ivanov, 2007) ANN technique for humidity sensor	~1%	High, large memory	Desktop PC
(Medrano-Marques et al., 2001) MLP for piecewise linearization of thermistor	<0.5%	High, large memory size depends on data points	μ C (16-bit ADC) no hardware results
(Islam et al., 2006) Adaptive NN, determine coefficient of polynomial (ADALINE)	2.7%	Low, can be more for higher-order polynomial	Op-amp based circuit
(Erdem, 2010) ANN for infrared distance	0.017%	High, large memory	PIC18F452 μ C (10-bit ADC) ST52F510 (10-bit resolution)
(Khan et al., 2003) MLP-based inverse ANN model for thermistor	<0.5%	High, low memory Optimized data points	PIC16F870 μ C (10-bit ADC)
(Kumar et al., 2015) Two stages linearization (i) optimizing the parallel form of R_{NTC} and fixed resistance and (ii) MLP	$\pm 0.2\%$	High, medium memory	μ C with AVR studio for coding various sensors with drift compensation
(Patra et al., 2008) Efficient learning machine (ELM) for the pressure sensor with temperature error	$\pm 1.5\%$	Medium	Xilinx Virtex-II FPGA board (12-bit ADC)
(Patra et al., 2008) Chebyshev neural network pressure sensor	$\pm 1\%$	High, computationally efficient basic MLP	Only simulation results
(Cotton and Wilamowski, 2011) Fully connected cascade NN	<1%	High, computationally efficient	μ C with 8-bit ADC
(Teodorescu) Fuzzy logic	0.07%	High, large memory	Simulation results for different nonlinearity
(Bouhedda, 2013) Neuro-fuzzy	0.03°C (high)	Medium, high memory less hardware than LUT	Xilinx Spartan-3A DSP 1800A FPGA board, MAX1132 ADC (16 bit)
(Xiaodong, 2008) software support vector machine humidity sensor	<0.05	Better than MLP fuzzy logic	MATLAB Neural Network Toolbox

ever, software-based digital methods, in general, offer more flexibility and accuracy. These methods can be implemented usually by PC or dedicated hardware such as a microcontroller, FPGA, or DSP processors. These processors offer programming flexibility to realize the function. However, to obtain high accuracy, these methods suffer from long processing time and the requirement of the costly processor. Accuracy depends on high speed and high-resolution processors. Otherwise, the simple linearization function can

be implemented with reduced processing complexity by low cost and low power processor.

Classical software methods and intelligent soft computing techniques such as ANN, fuzzy logic, neuro-fuzzy, and SVM with the genetic algorithm are extensively used for linearization. Performances of classical methods based on their hardware implementation on slow cost microcontroller are compared. It provides guidance for the selection of a method. Due to the advancement of microcontroller, FPGA, DSP proces-

sors, many works reported about the hardware implementation of the intelligent methods. But the classical methods are cost-effective, require less memory and give the faster response. However, the implementation of the intelligent methods like ANNs may be cost-effective, if the ANN structures are simpler requiring few signal processing units. Due to the continuous enhancement of research in the sensing technology, many new sensors are coming into the market, so many research articles are expected on this topic.

In summary, the linearization methods depend on the design and application priority. If the fast linearization and high accuracy are required with programming flexibility, then look-up table based approaches are still a better solution. Iterative soft computing methods are time-consuming and require more memory space for hardware implementation. Mixed-signal conditioning circuits are particularly suitable to the applications where the linearized sensor signal is to be in digital form and the signal processing time and power consumption are to be minimized. The comparison of various linearization schemes in terms of accuracy, complexity indicates that the selection of a method depends on the sensor nonlinearity, the capability of processor, required accuracy, execution speed, and application need.

Bibliography



Tarikul Islam (M'16-SM'19) born in Murshidabad, West Bengal, India. He received the MSc Engineering Degree in Instrumentation and Control System from A.M.U. Aligarh, UP in 1997 and the PhD (Engineering) Degree from Jadavpur University, Kolkata, India, in 2007. From 1997 to 2006, he was an Assistant Professor and from 2006 to 2012, he was an Associate Professor with the Electrical Engineering Department, Jamia Millia Islamia (J.M.I.), a Central University. Since 2012, he is working as a Professor with the same University. He has over 20 years of teaching and research experiences. He has authored/co-authored 4 book chapters, 1 edited book, 2 Indian patents and more than 140 papers in peer reviewed journals and conferences. His research interests include sensing technologies, and electronics instrumentation. He is an Associated Editor, *IEEE Sensors Journal and International Journal on Smart Sensing and Intelligent Systems*. He is Co-editor of a special issue of an International Journal of Electronics, MDPI.



S. C. Mukhopadhyay (M'97, SM'02, F'11) holds a BEE (Gold Medalist), MEE, PhD (India) and Doctor of Engineering (Japan). He has over 29 years of teaching, industrial and research experience. Currently, he is working as a Professor of Mechatronics Engineering, Macquarie University, Australia. His fields of interest include smart sensors and sensing technology, instrumentation techniques, wireless sensors and network, numerical field calculation, electromagnetics, etc. He has supervised over 40 postgraduate students and over 100 honors students. He has examined over 50 postgraduate theses. He has published over 450 papers in different international journals and conference proceedings, authored 6 books and 40 book chapters and edited 16 conference proceedings. He has also edited 30 books with Springer-Verlag and 20 journal special issues. He has organized over 20 international conferences as either General Chairs/co-chairs or Technical Program Chair. He has delivered 330 presentations including keynote, invited, tutorial, and special lectures. He is a Fellow of IEEE (USA), a Fellow of IET (UK), a Fellow of IETE (India), a Topical Editor of *IEEE Sensors Journal*, and an Associate Editor of *IEEE Transactions on Instrumentation and Measurements*. He is a Distinguished Lecturer of the IEEE Sensors Council from 2017 to 2019. He is the Founding Chair of IEEE IMS NSW Chapter.

gineering, Macquarie University, Australia. His fields of interest include smart sensors and sensing technology, instrumentation techniques, wireless sensors and network, numerical field calculation, electromagnetics, etc. He has supervised over 40 postgraduate students and over 100 honors students. He has examined over 50 postgraduate theses. He has published over 450 papers in different international journals and conference proceedings, authored 6 books and 40 book chapters and edited 16 conference proceedings. He has also edited 30 books with Springer-Verlag and 20 journal special issues. He has organized over 20 international conferences as either General Chairs/co-chairs or Technical Program Chair. He has delivered 330 presentations including keynote, invited, tutorial, and special lectures. He is a Fellow of IEEE (USA), a Fellow of IET (UK), a Fellow of IETE (India), a Topical Editor of *IEEE Sensors Journal*, and an Associate Editor of *IEEE Transactions on Instrumentation and Measurements*. He is a Distinguished Lecturer of the IEEE Sensors Council from 2017 to 2019. He is the Founding Chair of IEEE IMS NSW Chapter.

Acknowledgments

This work was supported by the DRDO, under the research grant (ERIP/ER/DG-MED&CoS/991115501/M/01/1656), New Delhi, India.

Literature Cited

- Abudhahir, A. and Baskar, S. 2008. An evolutionary optimized nonlinear function to improve the linearity of transducer characteristics. *Measurement Science and Technology* 19: 045103–045113.
- Alahi, M. E., Xie, L., Mukhopadhyay, S. C. and Burkitt, L. 2016. A temperature compensated smart nitrate-sensor for agricultural industry. *IEEE Transactions on Industrial Electronics* 64(9): 7333–7341.
- Azhari, S. and Kaabi, H. 2000. The current mode alternative of Wheatstone bridge. *IEEE Transactions on Circuits and Systems|Fundamental Theory and Applications*. 47(9): 1277–1284.

- Baker, B. C. 2005. Advances in measuring with non-linear sensors. *Sensor Magazine*, April doi: <https://www.fierceelectronics.com/components/advances-measuring-nonlinear-sensors>: access on July 17, 2019.
- Bandyopadhyay, S., Das, A., Mukherjee, A., Dey D., Bhattacharyya B. and Munshi S. 2016. A linearization scheme for thermistor-based sensing in biomedical studies. *IEEE Sensors Journal* 16(3): 603–609.
- Benammar, M. 2007. A novel amplitude-to-phase converter for sine/cosine position transducers. *International Journal of Electronic Business* 94: 353–365.
- Benammar, M., Ben Brahim, L. and Alhamadi, M. A. 2005. A high precision resolver-to-DC converter. *IEEE Transactions on Instrumentation and Measurement* 54: 2289–2296.
- Bengtsson, L. E. 2012. Lookup table optimization for sensor linearization in small embedded systems. *Journal of Sensor Technology* 2: 177–184.
- Bera, S. C. and Marick, S. 2012. Study of a simple linearization technique of pn-junction type anemometric flow sensor. *IEEE Transactions on Instrumentation and Measurement* 61(9): 2545–2552.
- Bera, S. C., Sarkar, R. and Mandal, N. 2012. An opto-isolator based linearization technique of a typical thyristor driven pump. *ISA Transactions* 51: 220–228.
- Bluemm C., Weiss R., Weigel R. and Brenk D. 2010. Correcting nonlinearity and temperature influence of sensors through B-spline modeling. IEEE International Symposium on Industrial Electronics, Bari, pp. 3356–3361.
- Bouhedda, M. 2013. Neuro-fuzzy sensor's linearization based FPGA. 7th IEEE International Conference on Intelligent Data Acquisition and Advanced Computing Systems: Technology and Applications, Berlin, September 12-14: 324–328.
- Bucci, G., Faccio, M. and Landi, C. 2000. New ADC with piecewise linear characteristic: case study implementation of a smart humidity sensor. *IEEE Transactions on Instrumentation and Measurement*. 49(6): 1154–1166.
- Burgués, J. and Marco, S. 2018. Multivariate estimation of the limit of detection by orthogonal partial least squares in temperature-modulated MOX sensors. *Analytica Chimica Acta* 1019: 49–64.
- Burgués, J., Manuel J., -Soto J. and Marco S. 2018. Estimation of the limit of detection in semiconductor gas sensors through linearized calibration models. *Analytica Chimica Acta* 1013: 13–25.
- Catunda, S. Y. C., Saavedra, O. R., FonsecaNeto, J. V. and Morais, M. R. A. 2003. Look-up table and break points determination for piecewise linear approximation functions using evolutionary. Conference: IEEE Instrumentation and Measurement Technology Conference, Vail: 435–44.
- Chavan, S. and Anoop, C. S. 2016. A simple direct-digitizer for giant magnetoresistance-based sensors. Proceedings IEEE International Instrumentation & Measurement Technology Conference, Taipei: 1–5.
- Chen, C. and Chen, H. W. 2016. A linearization time-domain CMOS smart temperature sensor using a curvature compensation oscillator. *Electronic Letter* 52(6): 458–460.
- Poki, C., Chun-Chi, C., Yu-Han, P., Kai-Ming, W. and Yu-Shin, W. 2010. A time-domain SAR smart temperature sensor with curvature compensation and a 3σ Inaccuracy of $0.4^{\circ}\text{C} \sim + 0.6^{\circ}\text{C}$ over a 0°C to 90°C range. *IEEE Journal of Solid-State Circuits* 45: 600–609.
- Constanti, A. 2017. Optimal design and modeling of tactile resistive and capacitive sensors interfaces used in modern mechatronics. *Romanian Journal of Information Science and Technology* 20(4): 400–414.
- Cotton, N. J. and Wilamowski, B. M. 2011. Compensation of nonlinearities using neural networks implemented on inexpensive microcontrollers. *IEEE Transactions on Industrial Electronics*. 58(3): 733–740.
- Daponte, A. P. and Grimaldi, D. 1998. Artificial neural networks in measurements. *Measurement* 23: 93–115.
- Das J., Dey S., Hossain, Rittersma Z. M. C. and Saha, H. 2003. A hygrometer comprising a porous silicon humidity sensor with phase-detection electronics. *IEEE Sensors Journal*, 3(4): 414–420.
- de Graaf, G. and Wolfenbuttel, R. F. 2006. Systematic approach for the linearization and readout of non-symmetric impedance bridges. *IEEE Transactions on Instrumentation and Measurement* 55(5): 1566–1572.
- Di Federico M., Poggi T. Pedro J. and Storace M. 2010. Integrated circuit implementation of multi-dimensional piecewise linear functions. *Digital Signal Processing* 20: 1723–1732.
- Dias Pereira, J. M., Postolache, O. and Silva Girao, P. 2005. Adaptive self-calibration algorithm for smart sensors linearization. IEEE Instrumentation and Measurement Technology Conference (IMTC 2005), 16–19 May, Ottawa.
- Dias Pereira, J. M., Silva Girão, P. and Postolache, O. 2001. Fitting transducer characteristics to measured data. IEEE Instrumentation and Measurement Magazine, pp. 26–29.
- Pereira J. M. D., Postolache O. and Silva Girao P. M. B. 2007. A digitally programmable A/D converter for smart sensors applications. *IEEE Transactions on Instrumentation and Measurement* 56(1): 158–163.
- Pereira, J. M. D., Postolache, O. and Silva Girao P. M. B. 2009. PDF-based progressive polynomial calibration method for smart sensors linearization. *IEEE Transactions on Instrumentation and Measurement* 58(9): 3245–3252.
- Didenko, V., Minin, A. and Movchan, A. 2002. Polynomial and piece-wise linear approximation of smart transducer errors. *Measurement* 31: 61–70.
- Doebelin, E. O. and Manik, D. N. 2011. *Measurement systems: application and design*, 6th ed., McGraw Hill, New Delhi, India.
- Erdem, H. 2010. Implementation of software-based sensor linearization algorithms on low-cost micro controllers. *ISA Transactions* 49(4): 552–558.

- Alahi Mohd, E. A., Nag, A., Manesh, A. F. M., Mukhopadhyay, S. C. and Roy J. K 2017. A simple embedded sensor: excitation and interfacing. in George, B., Roy, J. K., Jagadeesh Kumar, V. and Mukhopadhyay, S.C. (Eds), *Smart sensors, measurement and instrumentation 25* Advanced Interfacing Techniques for Sensors, ISBN 978-3-319-55368-9, Springer-Verlag, New York: 111–138.
- Farshidi, E. 2011. A low-voltage current-mode Wheatstone bridge using CMOS transistors. *International Journal of Electrical & Computer Sciences* 5(10): 1368–1372.
- Fericean, S., Dorneich, A., Droxler, R. and Krater, D. 2009b. Development of a microwave proximity sensor for industrial applications. *IEEE Sensors Journal* 9(7): 870–876.
- Fericean, S., Dorneich, A. and Droxler, R. 2009a. Development of a microwave proximity sensor for industrial applications. *IEEE Sensors Journal* 9(7): 870–876.
- Flammini, D. M. and Taroni, A. 1999. Application of an optimal lookup table to sensor data processing. *IEEE Transactions on Instrumentation and Measurement* 48(4): 813–816.
- Flammini, D., Marioli and Taroni, A. 1997. Transducer output signal processing using an optimal look-up table in microcontroller-based systems. *Electronics Letters* 33(14): 1197–1198.
- Flammini, D., Marioli and Taroni, A. 1999. Application of an optimal look-up table to sensor data processing. *IEEE Transactions on Instrumentation and Measurement* 48(4): 813–816.
- Fraden, J. 2003. *Hand book of modern sensors physics, designs and applications*, 3rd ed., Springer, advanced Monitors Corporation San Diego, California.
- Ghallab, Y. H. and Badawy, W. 2006. A new topology for a current-mode Wheatstone bridge. *IEEE Transactions on Circuits and Systems II: Express Briefs* 53(1): 18–22.
- Ghara, K., Saha, D. D. and Sengupta, K. 2008. Implementation of linear trace moisture sensor by nano porous thin film moisture sensor and NL Amp. *International Journal on Smart Sensing and Intelligent Systems* 1(4): 955–969.
- Hruskovic, L. S. 2001. Linearization of inverse-capacitance based displacement transducers. *Measurement Science and Technology* 12: 77–81.
- Islam, T. 2017. Advanced interfacing techniques for the capacitive sensor in George, B., Roy, J. K., Jagadeesh Kumar, J. and Mukhopadhyay, S. C. (Eds), *Smart sensors, measurement and instrumentation 25*, Advanced Interfacing Techniques for Sensors, ISBN 978-3-319-55368-9, Springer-Verlag: 73–109.
- Islam, T. and Saha, H. 2007. Study of long-term drift of a porous silicon humidity sensor and its compensation using ANN technique. *Sensors and Actuators A* 133(2): 472–479.
- Islam, T., Ghose, S. and Saha, H. 2006. ANN-based signal conditioning and its hardware implementation of a nanostructured porous silicon relative humidity sensor. *Sensors & Actuators, B* 120/1: 130–141.
- Islam, T., Mukhopadhyay, S. C. and Suryadevara, N. K. 2017. Smart sensors and internet of things: a post-graduate paper. *IEEE Sensors Journal* 17(3): 577–588.
- Islam, T., Kumar, L., Zaheruddin and Gango-padhyay A. 2013. Relaxation oscillator-based active bridge circuit for linearly converting resistance to frequency of resistive sensor. *IEEE Sensors Journal* 13(5): 1507–1513.
- Islam, T., Ur Rahman, Z. and Mukhopadhyay, S. C. 2014a. A novel sol-gel thin-film constant phase sensor for high humidity measurement in the range of 50%–100% RH. *IEEE Sensors Journal* 15(4): 2370–2376.
- Islam, T., Khan, A. U., Akhtar, J. and Rehman M. Z. 2014b. A digital hygrometer trace moisture measurement. *IEEE Transactions on Instrumentation and Measurement* 61(10): 5599–5605.
- Jafaripناه, M., Al-Hashimi, B. R M. and White, N. M. 2017. Application of analog adaptive filters for dynamic sensor compensation. *IEEE Transactions on Instrumentation and Measurement* 54(1): 245–251.
- Jafaripناه, M. J., Hashimi, B. A and White, N. M. 2005. Application of analog adaptive filters for dynamic sensor compensation. *IEEE Transactions on Instrumentation and Measurement* 54(1): 245–251.
- Jedlicska, I., Weiss, R. and Weigel, R. 2010. Linearizing the output characteristic of GMR current sensors through hysteresis modelling. *IEEE Transactions on Industrial Electronics* 57(5): 1728–1734.
- Jordana, J. and Pallas-Areny, R. 2004. Optimal two-point static calibration of measurement systems with quadratic response. IMTC 2004 IEEE Instrumentation and Measurement Technology Conference, Coma, May 18-20: 110–113.
- Kaliyugavaradan, S., Sankaran, P. and Murti, V. G. K. 1993. A new compensation scheme for thermistors and its implementation for response linearization over a wide temperature range. *IEEE Transactions on Instrumentation and Measurement* 42(5): 952–956.
- Kashiwa T., Ohnishi Y., Yamamoto K. and Ohshima H. 2005. A novel linearizing technique using dual diode. 13th GAAS Symposium, Vol. 58, No. 2, Paris, pp.601–60.
- Keem T., Gonda S., Misumi I., Huang Q. and Kurosawa T. 2005. Simple, real-time method for removing the cyclic error of a homodyne interferometer with a quadrature detector system. *Applied Optics* 44: 3492–6.
- Khan, S. A. and Islam, T. 2011. Precision active bridge circuit for measuring incremental resistance with ANN compensation of excitation voltage variation. *Journal of Sensor Technology* 1: 57–64.
- Khan, S. A., Shawani, D. T. and Aggarwal, A. K. 2003. Sensors calibration and compensation using neural network. *ISA Transaction* 42(3): 337–352.

- Kim, J. A., Kim, W. J., Kang, H. C., Eom, B. T. and Ahn, J. 2009. A digital signal processing module for real-time compensation of nonlinearity in a homodyne interferometer using a field-programmable gate array. *Measurement Science and Technology* 20: 17003–17010.
- Korotcenkov, G. and Cho, B. K. 2011. Instability of metal oxide-based conductometric gas sensors and approaches to stability improvement (short survey). *Sensors and Actuators B* 156: 527–538.
- Kraver, K. L., Guthaus, M. R., Strong, T. D., Bird, P. L., SigCha, G., Höld, W. and Brown, R. B. 2001. A mixed signal sensor interface micro instrument. *Sensors and Actuators A* 91: 266–277.
- Kumar, V. N., Narayana, K. V. L., Bhujangarao, A. and Sankar, S. 2012. A medium-range hygrometer using nano-porous thin film of γ - Al_2O_3 with electronics phase detection. *IEEE Sensors Journal* 12(5): 1625–1632.
- Kumar V. N., Narayana K. V. L., Bhujangarao A. Sankar S. 2015. Development of an ANN-based linearization technique for the VCO thermistor circuit. *IEEE Sensors Journal* 15(2): 886–894.
- Lanyi, S. and Hruskovic, M. 2001. Linearization of inverse-capacitance-based displacement transducers. *Measurement Science and Technology* 12: 77–81.
- Li, Z. and Dixon, S. 2016. A closed-loop operation to improve GMR sensor accuracy. *IEEE Sensors Journal* 16(15): 6003–6007.
- López-Lapeña, O., Serrano-Finetti, E. and Casas, O. 2016. Low-power direct resistive sensor-to-microcontroller interfaces. *IEEE Transactions on Instrumentation and Measurement* 65(1): 222–230.
- López-Martín, A. J. and Carlosena, M. Z. A. 2003. CMOS A/D converter with piecewise linear characteristic and its application to sensor linearization. *Analog Integrated Circuits and Signal Processing* 36 Nos 1-2: 39–46.
- Lopez-Martin, A. J. and Carlosena, A. 2013. Sensor signal line-arization techniques: a comparative analysis, 2013 IEEE 4th Latin American Symposium on Circuits and Systems (LASCAS), 27 Feb.-1 March 2013:1–4.
- Lucaa, D., Pathirana, V. and Ali, S. Z. 2015. Experimental, analytical and numerical investigation of non-linearity of SOI diode temperature sensors at extreme temperatures. *Sensors and Actuators A* 222: 31–38.
- Lukić, J. and Denić, D. 2015. A novel design of an NTC thermistor linearization circuit. *Metrology and Measurement Systems* 22(3): 351–362.
- Mahaseth, D., Kumar, L. and Islam, T. 2018. An efficient signal conditioning circuit to piecewise linearizing the response characteristic of highly nonlinear sensors. *Sensors and Actuators A* 280.
- Mahboob, M. R., Zargar, Z. H. and Islam, T. 2016. A sensitive and highly linear capacitive thin film sensor for trace moisture measurement in gases. *Sensors and Actuators B* 228: 658–664.
- Marconato, A., Hu, M., Boni, A. and Petri, D. 2008. Dynamic compensation of nonlinear sensors by a learning-from-examples approach. *IEEE Transactions on Instrumentation and Measurement* 57(8): 689–1694.
- Maundy, B. and Gift, S. J. G. 2013. Strain gauge amplifier circuits. *IEEE Transactions on Instrumentation and Measurement* 62(4): 693–700.
- MAX1457 1998. 0.1%-Accurate signal conditioner for piezoresistive sensor compensation. available at: <http://www.maxim-ic.com>, 24/4/2019.
- Medrano-Marques, N. J. and Martin-del-Brio, B. 2001. Sensors linearization with neural networks. *IEEE Transactions on Industrial Electronics*. 48(6): 1288–1290.
- Meireles, M. R. G., Almeida, P. E. M. and Simoes, M. G. 2003. A comprehensive review for industrial applicability of artificial neural networks. *IEEE Transactions on Industrial Electronics* 50(3): 585–599.
- Mohan, N. M., Kumar, V. J. and Sankaran, P. 2011. Linearizing dual-slope digital converter suitable for a thermistor. *IEEE Transactions on Instrumentation and Measurement* 60(5): 1515–1521.
- Mohan, N. M., Geetha, T., Sankaran, P. and Kumar, V. J. 2008. Linearization of output of a Wheatstone bridge for single active sensor. Proceedings of the 16th IMEKO Symposium, Florence, pp. 22–24.
- Mondal, N., Abutahir, A., Jana S. K., Munshi S. and Bhattacharya D. P. 2009. A log amplifier-based linearization scheme for thermocouples. *Sensors and Transducers Journal*. 100(1): 1–10.
- Munoz, D. R., Moreno, J. S. and Escriva, C. R. 2008. Constant current drive for resistive sensors based on generalized impedance converter. *IEEE Transactions on Instrumentation and Measurement* 57(10): 2290–2296.
- Murmu, B. B. and Munshi, S. 2018. A synergy of voltage-to-frequency converter and continued-fraction algorithm for processing thermocouple signals. *Measurement* 116: 514–522.
- Nagarajan, P. R., George, B. and Kumar, V. J. 2017. A linearizing digitizer for Wheatstone bridge-based signal conditioning of resistive sensors. *IEEE Sensors Journal* 17(6): 1696–1705.
- Nenov, T. and Ivanov, S. 2007. Linearization of characteristics of relative humidity sensor and compensation of temperature impact. *Sensors and Materials* 19(2): 095–106.
- Nenova, Z. P. and Nenov, T. G. 2009. Linearization circuit of the thermistor connection. *IEEE Transactions on Instrumentation and Measurement* 58(2): 441–449.
- Nitzan Sarah, H., Taheri-Tehrani, P., Defoort, M., Sonmezoglu, S. and Horsley, D. A. 2016. Countering the effects of nonlinearity in rate-integrating gyroscopes. *IEEE Sensors Journal* 16(10): 3556–2563.
- O'Droma, N. S. and Mgebrishvili, N. 2005. Signal modeling classes for linearized OFDM SSPA behavioral analysis. *IEEE Communications Letters* 9(2): 127–129.
- Optimized Sensor Linearization for Thermocouple 2015. TI Designs: Optimized Sensor Linearization for Thermocouple, Texas Instruments, Dallas, Texas, USA: 1–28, Date of access: 24/4/2019.

- Pappas, I., Laopoulos, Th., Vlassis S., and Siskosa S. 2011. Current mode interfacing circuit for flow sensing based on hot-wire anemometers technique. *Procedia Engineering* 25: 1601–1604.
- Patra, C., Chakraborty, G. and Meher, P. K. 2008. Neural-Network-based robust linearization and compensation technique for sensors under nonlinear environmental influences. *IEEE Transactions on Circuits and Systems – I* 55(5): 1316–1327.
- Patra, J. C., Juhola, M. and Meher, P. K. 2008. Intelligent sensors using computationally efficient Chebyshev neural network. *IET Science, Measurement and Technology* 2(2): 68–75.
- Patra J.C., Meher P.K., Chakraborty G. 2011. Development of Laguerre neural-network-based intelligent sensors for wireless sensor networks. *IEEE Transactions on Instrumentation and Measurement* 60(3): 725–734.
- Patranabis, D., Ghosh, S. and Bakshi, C. 1988. Linearizing transducer characteristics. *IEEE Transactions on Instrumentation and Measurement* 37(1): 66–69.
- Piao, L., Hu, Y. and Chang, X. 2017. Software compensation technology of the piezoelectric fluidic gyroscope based on DSP. pp. 1444–1448.
- Rahili, S., Ghaisari, J. and Golfar, A. 2012. Intelligent selection of calibration points using a modified progressive polynomial method. *IEEE Transactions on Instrumentation and Measurement* 61(9): 2519–2523.
- Ramadoss, N. and George, B. 2015. A Simple micro-controller based digitizer for differential inductive sensors, 2015 IEEE International Instrumentation and Measurement Technology Conference (I2MTC) Proceedings, 11–14 May 2015, Pisa, Italy:1–6.
- Reverter F., Jordana J., Gasulla M. and Pallàs-Areny R. 2005. Accuracy and resolution of direct resistive sensor-to-microcontroller interfaces. *Sensors and Actuators A* 121: 78–87.
- Rivera, J., Herrera, G. and Chacon, M. 2009. Improved progressive polynomial algorithm for self-calibration and optimal response in smart sensors. *Measurement* 42: 1395–1401.
- Rudtsch, S. and von Rohden, C. 2015. Calibration and self-validation of thermistors for high precision temperature measurement. *Measurement* 76: 1–6.
- Sanyal, N., Bhattacharya, B. and Munshi, S. 2006. An analog non-linear signal conditioning circuit for constant temperature anemometer. *Measurement* 39: 308–311.
- Sarkar, A. R., Dey, D. and Munshi, S. 2013. Linearization of NTC thermistor characteristic using op-amp based inverting amplifier. *IEEE Sensors Journal* 13(12): 4621–4626.
- Sarma, U. and Barua, P. K. 2010. Design and development of a high precision thermocouple based smart industrial thermometer with online linearization and data logging feature. *Measurement* 43: 1589–1594.
- Scheiblhofer, S., Schuster, S. and Stelzer, A. 2006. Signal model and linearization for nonlinear chirps in FMCW radar saw-id tag request. *IEEE Transactions on Microwave Theory and Techniques* 54(4): 1477–1483.
- Sen, T., Anoop, C. S. and Sen, S. 2018. Simple front-end circuit for giant magneto resistive sensor. *Electronics Letters* 54(2): 81–83.
- Sen, T., Sreekantan Anoop, C. S. and Sen, S. 2017. Design and performance evaluation of two novel linearization circuits for giant magneto resistance-based sensors. *IET Circuits Devices System* 11(5): 496–503.
- Sen Gupta, G. and Mukhopadhyay, S. C. 2010. *Embedded microcontroller interfacing: designing integrated projects*, Vol. 65, ISBN 978-3-642-13635-1, Lecture Notes in Electrical Engineering, Springer-Verlag, Berlin Heidelberg.
- Humidity & Temperature Sensmitter. Application note: nonlinearity compensation, Sensirion, the sensor company, Staefa ZH, Switzerland.
- De la Hoya, E. S., Casas, O., Reverter, F. and Pallàs-Areny R. 2008. Direct interface circuit to linearize resistive sensor bridges. *Sensors and Actuators A* 147: 210–215.
- Silva, A. V., Leitao, D. C., Valadeiro, J., Amaral, J., Freitas, P. P. and Cardoso, S. 2015. Linearization strategies for high sensitivity magneto resistive. *Sensors, The European Physical Journal Applied Physics* 72.1 10601–10620.
- Sreekantan, C. and George, B. 2014. A linearizing digitizer for differential sensors with polynomial characteristics. *IEEE Transactions on Instrumentation and Measurement* 63(5): 1022–1031.
- Stanković, S. B. and Kyriacou, P. A. 2012. The effects of thermistor linearization techniques on the T-history characterization of phase change materials. *Applied Thermal Engineering* 44: 78–84.
- Tajima, T., Okabe, Y., Tanaka, Y. and Seyama, M. 2017. Linearization technique for dual-wavelength CW photo acoustic detection of glucose. *IEEE Sensors Journal* 17(16): 5079–5082.
- Islam T., Zaheeruddin and Gangopadhyay A. 2015. Temperature effect on capacitive humidity sensors and its compensation using artificial neural networks. *Sensors & Transducers* 191(8): 126–134.
- Teodorescu, H. N., Fuzzy logic system linearization for sensors. International Symposium on Signals, Circuits and Systems (ISSCS), July 13-14 2017, Lasi, Romania.
- Warsito, Suciayati S. W., Pauzi G. A., Putra B. L., Aprilia S. and Kurniati L. 2014. Calibration and digital linearization of ultrasonic transducer response. *Sensors & Transducers* 183(12): 48–52.
- Wells, C. 2011. Signal conditioning and linearization of RTD sensors. Texas instruments HPA precision linear applications. Dallas, Texas.
- Xiaodong, M. Y. 2008. Hysteresis and nonlinearity compensation of relative humidity sensor using support vector machines. *Sensors and Actuators B* 129: 274–284.
- Wang X., Wei G. and Sun J. 2011. Free knot recursive B spline for compensation of nonlinear smart sensors. *Measurement* 44: 888–894.

Ye G., Liu H., Fan S., Li X., Yu H., Lei B., Lei S. Y. Yin B. Y. 2014. Design of a precise and robust linearized converter for optical encoders using a ratiometric technique. *Measurement Science and Technology* 25: 125003–125011.

Ye, G., Liu, H., Fan, S., Li, X., Yu, H., Lei, B., Lei, S. Y. and Yin, B. Y. 2015. Precise and robust position estimation for optical incremental encoders using a linearization technique. *Sensors and Actuators A* 232: 30–38.

Zhang, Y., Zhu, J., Sun W., Lu Y., Wang F. and Yu W. 2016. Wide range temperature sensor with adaptive

nonlinearity cancellation (ANC) technique for HVICs. *Electronics Letter* 52(6): 458–460.

Zhou, L. and Chakrabarty, S. 2017. Linearization of CMOS hot-electron injectors for self-powered monitoring of biomechanical strain variations. *IEEE Transactions on Biomedical Circuits and Systems* 11(2): 446–454.

Žorić, A. Č., Martinović, D. and Obradović, S. 2006. A simple 2D digital calibration routine for transducers. *Facta University (NIŠ): Electronics and Energetics* 19(2): 97–207.