

Consideration of arrayed e -beam microcolumn based systems potentialities for wafer defects inspection

V.V. Kazmiruk, T.N. Savitskaja

Institute of Microelectronics Technology and High Purity Materials, Russian Academy of Sciences

Abstract

The e -beam column which is intended on defects inspection is considered. The defects which are to be examined or potentially might be examined at inspection stage are briefly considered. Interrelations between the system parameters is ascertaining and the ways of optimization and the technical requirements to the system in whole are discussed. As a result, we find the optimal combinations of the system parameters for the purpose.

Introduction

The development and manufacture of solid state microstructures involves many intricate processes for their creating. Along with the highly developed technologies used to manufacture micro and nanostructures, there is need for testing processes which would be adequate to those technologies by resolution, sensitivity and throughput. This is the increasingly important to shorten product development cycles and to increase the product yield.

Basically, test processes comprise inspection and review stages. The first one is used to detect, identify and locate defects (or potential defects) on wafer. After the potential defects are located a review stage is conducted. As usually the review process involves much more detailed examination of individual defects. For instance, the size, shape, nature and cause of defect can be determined.

The key question should be answered by inspection process is total amount of defects on wafer and possibility to return the wafer for further processing if it is assumed some tolerable probability to have at output an acceptable yield.

The aim of review stage is to determine the cause of the defect appearance in order to improve a technology and exclude such defects in a future, or at least decrease their amount. Usually this stage does not contemplate to return the wafer into technology process. Often it is used in combination with other techniques as for instance X-ray microanalysis, selective ion etching performed by FIB and so on.

At the present time for defect inspection are using the systems based on light optics. These are highly automated systems with inspection speed about 1 cm^2 in 10 sec, which means approximately one wafer in a hour. However, their resolution is limited by $0,25 \mu\text{m}$.

As electron beam can be focused into spot a few nanometers only, a solution seems to be obvious: just to replace the light optics on *e*-beam column, taken from a SEM as for instance.

However, after more detail consideration of that idea one can see three main obstacles on this way. The first consists in the principle of implemented method for image formation, eg in pixel-by-pixel scanning. Lowering the pixel size we quadratically decrease an inspection speed.

The second obstacle is that differently from the light, an *e*-beam is interacting with a sample, which might be a cause of radiation damage. On the other hand, some SEM methods are based on electron scattering computation to extract useful information, so that phenomena can play positive role either.

And the third, that whole image formation process, starting from the beam generation and ending by signal detection, has a statistical character. This also can put some limitations on the inspection system characteristics.

All that means that for creation of the system, and even more so its optimization, it is necessary to describe the whole system behavior, including above mentioned factors. Just after that is possible to synthesize an optimal system.

Often, when estimating a SEM, are considering just one its parameter — the resolution. Some time is added accelerating voltage, and then SEM is called something like "Low voltage high resolution SEM" et cetera. And the best SEM in resolution is assumed to be the best for any application. In this work we have put at the first place the application.

In other words, the aim is to create the system which is focused on concrete application — defects inspection, and with such combination of parameters that to the maximum adapted for this particular task.

In the first part of the work are considering briefly defects which to be examined or potentially might be examined at inspection stage.

In the second part interrelations between the major system parameters is ascertaining. The ways of optimization and technical requirements to the both components and system at whole are discussed.

I. The structures parameters

Solid state micro and nanostructures are described by 3 groups of parameters:

- geometrical dimensions and configuration of the structure's elements;
- metallurgical parameters as elemental composition, distribution of impurities and defects on wafer and so on;
- local electrical parameters as concentration of free charge carriers, their mobility and life time, dielectrical constants and so on.

The process of production of semiconductors includes processing of a circular silicon wafer typically 8" in diameter. The processing includes repetition of series of steps: oxidation and deposition; lithography; etching and doping (implanting and diffusing).

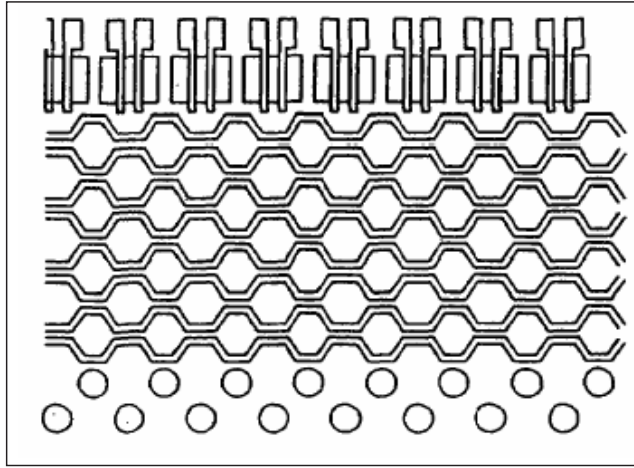

Fig. 1 *a*. Normally fabricated pattern

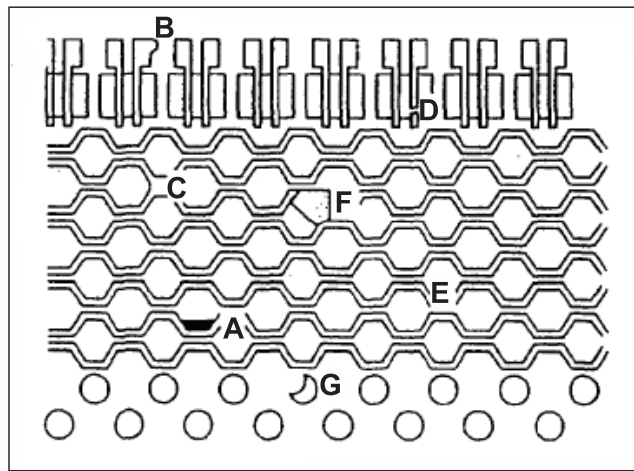
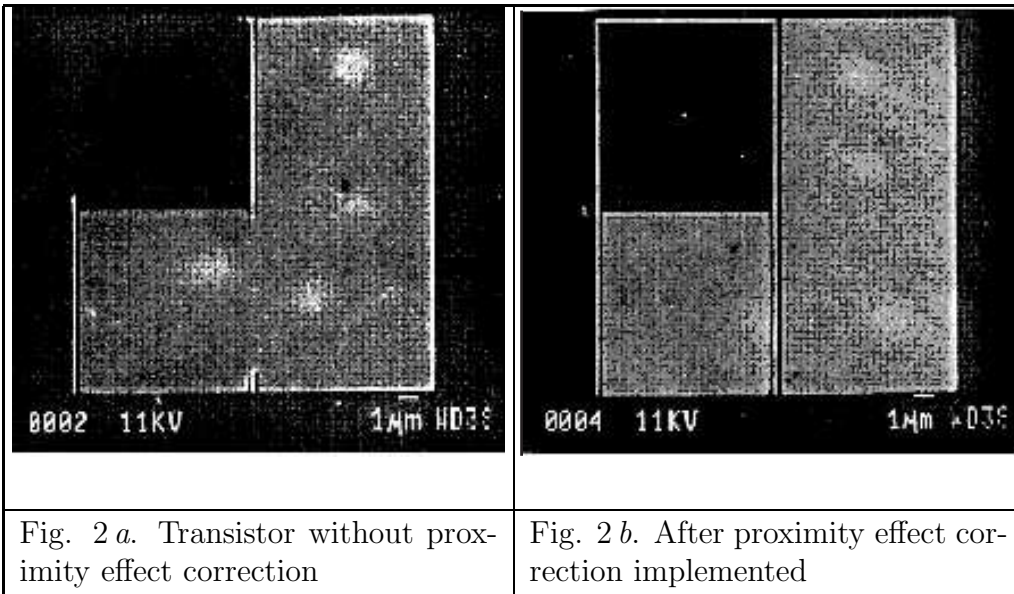

Fig. 1 *b*. Pattern having a defect **A**: isolated defect **B**: protrusion **C**: short **D**: omission **E**: disconnection **F**: thin film residual **G**: bad aperture

Depending on the maturity of the production process used, the wafer might be inspected for particles/production defects, mask alignment and critical dimension metrology between the processing steps. The frequency of inspection can be as often as every wafer in the development phase of a process, or on wafers from alternate production lots from mature processes.

Particle (production defect) detection detects either the presence of contaminant particles introduced in the manufacturing process, or areas where processing has been defective so as to produce unwanted features in the structures of the device. An example of defects caused by manufacturing process is given at fig. 1. These are so-called topographical defects.

SEM-based inspection systems for this kind of defects have been proposed using die-to-die comparison methods. Such systems are optimized to obtain topographical information. Known techniques have small pixel size ($0,1 \mu\text{m}$) and consequently very long inspection times, of the order of 10 to 80 hours for a complete wafer.



Two more defects caused by *e*-beam lithography are shown on fig. 2 and fig. 3.

At fig. 2 *a* is shown top plan view of FET transistor which has been exposed without including into consideration an existence of proximity effect. As a result the gap between drain and source has been over exposed. After developing process and metal deposition has been formed short circuit between all the electrodes. At fig. 2 *b* is shown the same kind of transistor after problem was fixed.

At fig. 3 *a*, *b* is shown a test structure to study *e*-beam lithography defects caused by hysteresis of deflection system. After all the temporary delays have been included into account and compensated by programming means, then was possible to achieve a desired result (fig. 3 *b*).

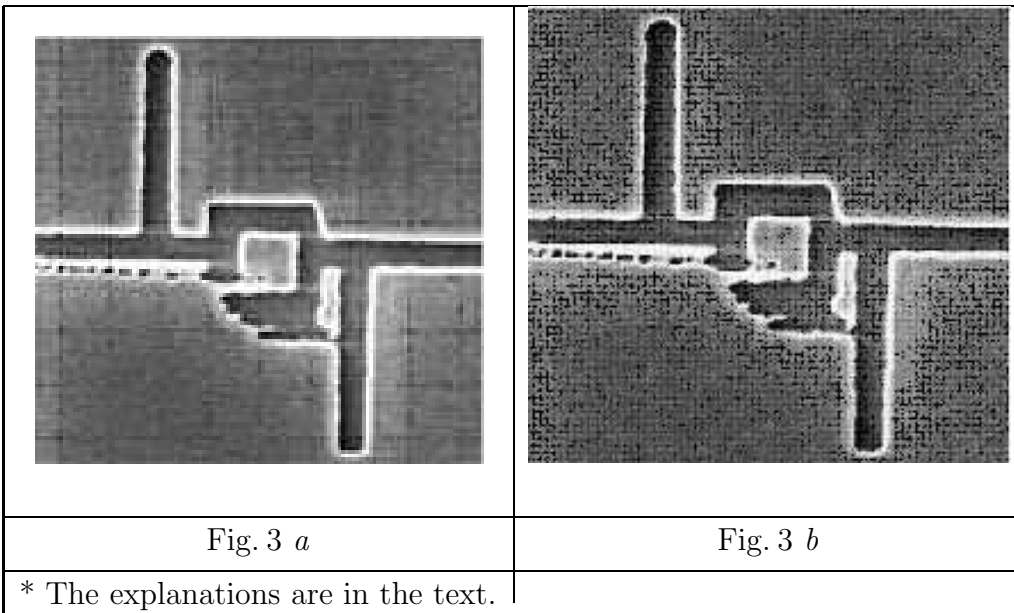

The defects (particles) can be subdivided into two groups: those which will affect the operation of the completed structure or device, which are known as "killer" defects, and those which have no harmful effect, known as "nuisance" defects. As for instance, protrusions **B** on fig. 1 *b* is a rather nuisance defects, and all the rest are killer defects. The small particles on transistor which are clearly seen on fig. 2, are nuisance defects, and both short circuit on fig. 2 *a* and lithography defects on fig. 3 *a* are "killer" defects. On the other hand, the nuisance defects can account for 90% of detected defects; therefore, some form of review is required to ensure that wafers which would otherwise produce acceptable yields are not rejected.

One more thing is that some of defects as thin film residuals are not clearly seen at the SEM image. That can be both killer and nuisance defects. Have been proposed the methods of such defects inspection based on voltage contrast (US patent #7,132,301 B1) The idea is explained by fig. 4, 5.

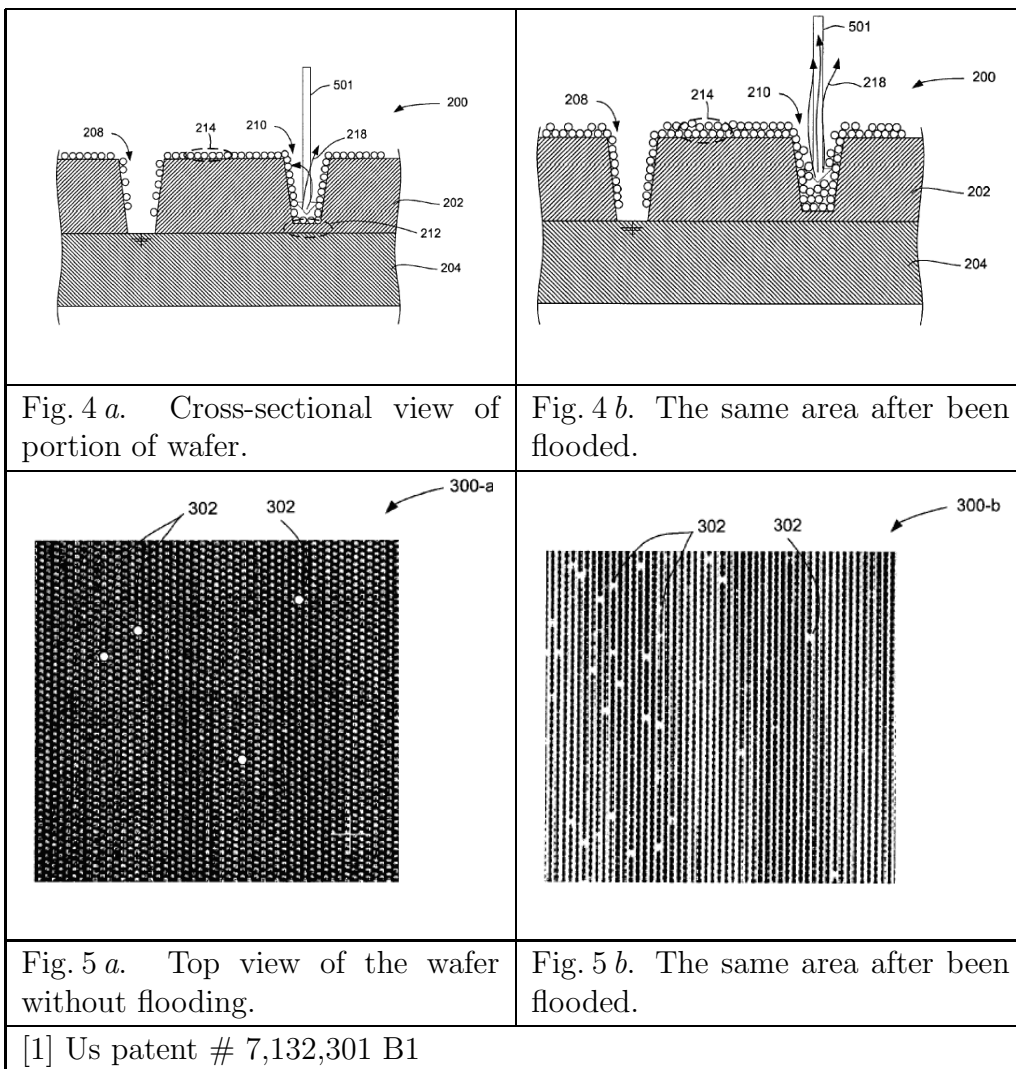

If a focused *e*-beam is scanning over the wafer it is charging some existing thin film residuals as it's shown diagrammatically on Fig. 2a. The value of the charge depends on several parameters as film thickness, beam energy, dose of irradiation and so on. In some places, where big enough negative charge is

occurred, on the SEM image are seen bright areas. Those areas are potentially "weak" points where defects might exist or arise in a future. The reason of such signal formation is that negative voltage on the surface creates a local accelerating field between irradiated point and detector, which directs the slow secondary electrons (SE) towards detector. This kind of contrast is called quantitative voltage contrast. The voltage contrast can be enhanced when using additionally one or more flooding beam. The "flooding" means some process when large enough electron beam covers homogeneously the whole wafer or inspected area. When the wafer has been flooded (see fig. 4 *b*), the negative charge is increased and many more weak points become seen on the image (compare image fig. 5 *a* and *b*).

The main method of extracting information by pictures comparison is based on the assumption that in a SEM just as in light microscope, the sample is adequately represented by its image.

The commonly accepted definition for that kind of data is *qualitative information*, while a lot of statistical information can be achieved by image analyzing. For example, these are number of particles and defects, their distribution by size and that sort of things.

Another kind of information which is obtained from SEM signal directly or by applying some algorithm commonly is defined as *quantitative information*.

Leaving apart the discussion about details, we just note that qualitative information is related to image and quantitative information is related to the signal from a SEM detector.

One of the earliest and the most developed methods is critical dimensions (CD) measurement or, according to another authors, line width (LW) measurement.

One more example of defects is shown on fig. 6, 7 and 8. These are structures for X-ray focusing. In ideal case the depth of all the trenches has to be the same. This determines a X-ray quality. However, after ion etching one can clearly see that trench depth is decreasing with decreasing its width.

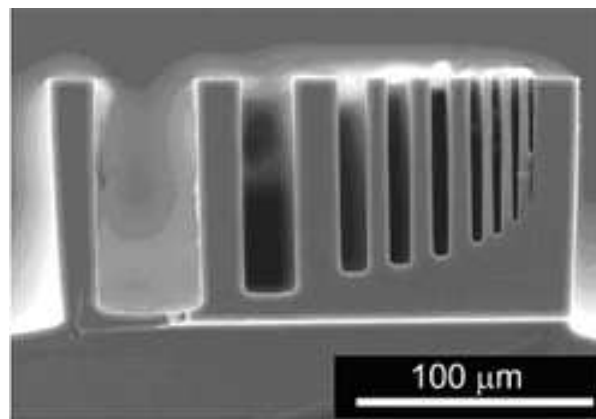

Fig. 6. Cross sectional view of X-ray focusing lens [2]

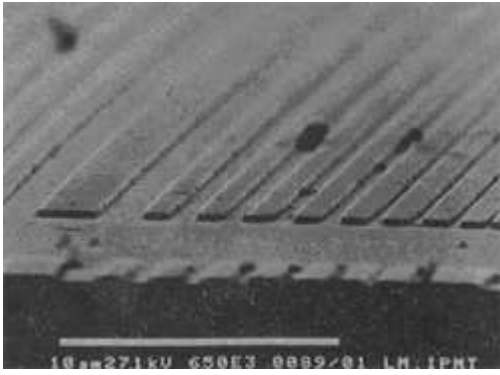

Fig. 7. Zone plate, tilted

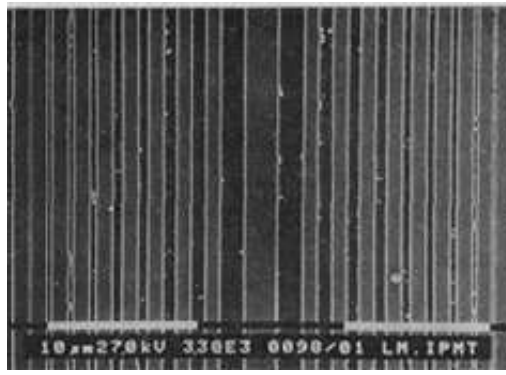

Fig. 8. Zone plate, top view

It is significant, that depth decreasing depends rather on aspect ratio than on absolute step dimensions. So this kind of defects has been seen on the structures with elements both in micron range (fig. 6) and in sub micron range (fig. 7, 8).

It is necessary to control line width and a shape of the elements for elliptical and round elements. All these structures always have been studied at review stage, while with expanding of such things production the need in inspection system will be growing.

Has been developed both an algorithm for surface microrelief reconstruction, based on theory of signal formation in a SEM [3], and method and attachment to a SEM for microprofilometry [4].

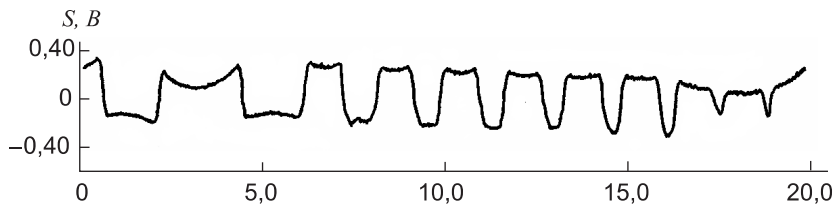

Fig. 9. Line scan taken from image 3; X-length in Microns

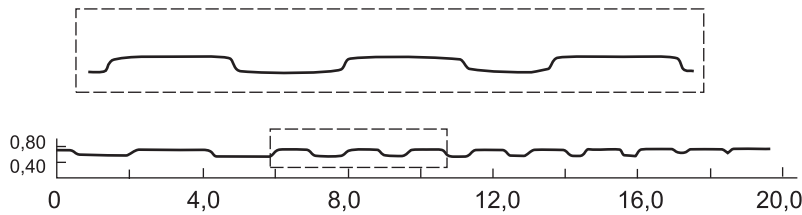

Fig. 10. Reconstructed surface profile along line scan

It is shown in fig. 5 a memorized signal taken from top view of structure with "shallow" steps. Typically this signal is used for line width measurements. The reconstructed profile is shown at fig. 6. It is obvious that from this profile can be extracted much more statistical data about structure geometry than from usual line scan.

II. The system requirements

The throughput

First of all we consider a correlation between beam diameter and throughput. As the throughput T (or rather inspection speed) is understood irradiated area for one sec. Therefore $T = A/t$, where A is usually in cm^2 .

A typical value for light optics systems is $T = 0,1$, which means that wafer 200 mm in dia. Is inspected in 52 minutes.

To understand better the limitations, caused just by method of surface irradiation (e.g. progressive scanning), is assumed for the beginning that we have an "ideal" e -beam which can be focused in any small spot with extremely high current.

For arrayed microcolumns an inspection speed can be written as $T = (\Delta^2/t) \cdot N$, where Δ is a distance between neighbour irradiated pixels which is assumed to be equal beam diameter and resolution, N — quantity of microcolumns.

To estimate N we assume for the beginning that each microcolumn needs a space $5 \times 5 \text{ mm}^2$ at the surface, so array for inspection 200 mm wafer could contain 1000 microcolumns.

Dwell time $t = 100 \text{ nsec}$.

The results of throughput calculations for conventional SEM ($N = 1$) and array with 1000 microcolumns and different resolution are shown in tab. 1.

Table 1.

Resolution, nm	Inspection Speed, cm^2/sec		Time for wafer inspection, hr	
	SEM	Array	SEM	Array
2	0,0000004	0,0004	218055,5	218,0
10	0,00001	0,01	8722,2	8,7
30	0,00009	0,09	969,1	0,96
50	0,00025	0,25	348,8	0,35
100	0,001	1	87,2	0,087

From this simple example is possible to come to a few important conclusions.

The main limitation on the way to combine a good resolution with high throughput is the inspection method (progressive scanning) itself. By increasing resolution we are decreasing quadratically the throughput, which makes the use of SEM based system below 100 nm quite impractical. As for arrayed microcolumns, they are potentially competitive in throughput with light optics systems starting from resolution 30 nm.

Our consideration does not include into consideration any hint for inspection time shortening as partial inspection and statistical methods, when some small part of the wafer is inspected and the results further are expanded on the whole wafer.

Signal-to-noise ratio (SNR)

Differently from light optics both e -beam generation and emission of secondary electrons are statistical processes.

Here we shall calculate the beam current that must be used to give an acceptable SNR in the recorded image or required accuracy for quantitative measurements. We calculate SNR in the "noise bottleneck" where numbers of signal quanta have the smallest value. For SEM in the secondary electron mode the "noise bottleneck" is between the sample and the collector. According to the theory [5], if there are N (on average) signal quanta at that point, then this will be associated with a random fluctuation \sqrt{N} . Then

$$\text{SNR} = N/\sqrt{N} = \sqrt{N}.$$

For further calculations SNR is denoted as n .

$$S = I_b \delta \alpha t \tag{1},$$

where I_b is primary beam current (A), δ — secondary emission coefficient, α — efficiency of electrons collection by detector and t — dwell time (sec), e. g. time of one pixel irradiation. So signal is expressed in units of charge — Coulombs (or A·sec).

As $1 \text{ C} = 6,25 \cdot 10^{18}$ electrons, the (1) can be expressed in terms of quantity of collected electrons:

$$N = 6,25 \cdot 10^{18} \cdot I_b \delta \alpha t. \tag{2}$$

Secondary emission coefficient for Si is equal $\delta = 0,2$ in wide range of beam energies, and collection efficiency can vary from 0,01 to 0,9. For the most often used Everhart–Thornley detector α is approximately 0,5, so for further estimations is assumed that the product $\delta\alpha$, which shows an efficiency of the primary electrons transformation to useful signal at detector input, typically is equal 0,1. The dwell time is assumed to be as before: $t = 10^{-7} \text{ sec}$.

Thus, the equation (2) can be written as:

$$N = 6,25 \cdot 10^{10} I_b. \tag{3}$$

Formula (3) allows one to calculate a required primary beam current for any in advance given SNR.

Usually is considered necessary to have $n = 3$ for detection of existence a change of some parameter value. This smallest detectable change is often called threshold of sensitivity or "resolution", for instance, voltage resolution, height resolution and that sort of thing.

For good quality image that worth to be sent to a magazine $n = 16 \div 20$. In practice, when working close to the resolution limit, a considerably higher level of noise can be tolerated in the image. For example, if primary beam current is 1 nA, then from (3) SNR is

$$n = 62,5^{0,5} = 7,9,$$

which seems to be acceptable for many practical inspection purposes.

When measuring the signal value, the accuracy is reversely proportional to n and error can be written as

$$\text{Measurement error} = (1/n) \cdot 100 \%$$

It is very important to remember that above estimated values of SNR related to the background only in order to demonstrate that this background is a not just constant value, but in part a noisy component of the informative signal. If useful signal is less than fluctuations in a background, it will be not seen.

It should be noted here that SNR can be deteriorated by other noisy components which are not related to the specimen, as detector is not positional sensitive. It accounts just an integral number of electrons at its input. So if some of electrons are reflecting inside the SEM chamber or inside the column and finally are coming on detector, they are considering as useful information. That can cause confusing artifacts, so great care should be taken of SEM construction.

Radiation damage and contamination

In contrast to the light quanta, the electrons interact with a specimen. A diameter of scattering zone inside the specimen for Si substrate can be written as $D = 0,032E^{5/3}$, where D is expressed in microns and beam energy E in keV. For 1 keV energy $D = 32$ nm.

Electron scattering should be taken into consideration when considering an informative properties of the secondary emission signals [3,5].

However, damaging influence of electron irradiation on the solid state is examined absolutely insufficiently, especially in the range of SEM energy range 1 to 30 keV. Nevertheless, there are some data [6] which show that irreversible changes in transistor structures properties (leakage current and cutoff voltage) are determined by irradiation dose:

$$D = I_{bt}/S, \tag{4}$$

where S is irradiated area. Also have been discovered changes in geometry of masks for X-ray lithography after irradiation with dose $D = 10^{-18}$ C/nm², what means in terms of electrons 6,25 el/nm².

The above dose value seems to be small enough, however, it is equal to sensitivity of well known PMMA electron resist. So if is inspecting a wafer with some exposed and developed pattern on it, then after next step of development this pattern will disappear.

Such multiple exposing and development procedure is widely used in e-beam lithography for stitching of fragments to one big pattern. And an inspection of the previous fragment also serves as alignment procedure for correct positioning the following fragment and so forth.

The above examples show that a possibility of radiation damage should be taken into consideration when developing the concept of inspection system exactly for such sensitive things.

In the following estimations as D is understood its current value and as D_m is taken the most acceptable value.

It has to be understood that high resolution is unavoidably connected with danger of sample radiation damage. As for example estimate a radiation dose when recording a photo to confirm the SEM resolution. Typical time for image recording is 80 sec. and picture format is 1024×1024 pixels. If claimed SEM resolution is 2 nm then pixel size is the same value and irradiated field is about 4 square microns. If we assume that primary beam current is just 10 pA then dose is

$$D = 2 \cdot 10^4 \mu\text{C}/\text{cm}^2,$$

which is 200 times more than chosen D_m .

Additionally, after such sample irradiation one can see at lower magnification that exposed area becomes dark. That happens because of contamination caused by cracking of the long residual oil molecules into shorter ones and adsorption of those on the surface. This adsorption layer can hardly be removed. For example, we used that layer as a mask for ion etching processing, and made sub micron structures with high (up to 10) aspect ratio.

Definition of the signal contrast

Assume that the signal S described by equation (1) is changed because of change secondary emission coefficient δ by value $\Delta\delta$. The change of the signal can be written as

$$\Delta S = I_b \Delta\delta \alpha t. \quad (5)$$

And the contrast of the signal is defined as

$$C = \Delta S/S. \quad (6)$$

It is essential to note that definition of the contrast (4) differs from that often using in the literature $C = \Delta S/S_{\max}$. However, the definition (4) is more convenient for analytical applications, when by contrast is calculating height of steps or depth of trenches on the wafer. Then the signal S from flat surface is used as a reference, which can be measured very precisely.

The reasons of local changes of secondary emission coefficient are numerous and usually they give a name to type of contrast: topography contrast, material (Z) contrast etc.

The correlation between resolution, signal contrast, dose and SNR

It is assumed as before that electron beam has diameter d with current I_b , and registration (and irradiation) time is t .

Further, it is assumed that change of signal ΔS is small enough that noise is still defining by formula (2) as \sqrt{N} . Therefore, SNR value n can be written as

$$n = \Delta S/(S)^{0,5}$$

or, if substitute here C from (6) it can be rewritten as

$$n = C \cdot (S)^{0,5}, \quad (7)$$

or in full form

$$n = C \cdot (6,25 \cdot 10^{18} \cdot I_b \delta \alpha t)^{0,5}. \quad (8)$$

Then define dose as $D = 6,25 \cdot 10^{18} \cdot I_b t / (\pi d^2 / 4)$ and substitute the product $6,25 \cdot 10^{18} \cdot I_b t$ into (8), we shall have a final equation:

$$d_{\min} = n / C_{\min} \cdot E \cdot (D)^{0,5}, \quad (9)$$

where $E = (\delta \alpha)^{0,5}$, d is expressed in nm, and D — in el/nm².

The meaning of equation (9) should be explained in more detail, because such an approach is used just author. At least author did not see it somewhere else in the literature.

This formula reflects the existing situation with transformation of information in a SEM. It shows that each square nanometer of the circle with diameter d when irradiated with limited amount of electrons is forming a signal (image) strongly determined quality, that for given in advance value of SNR is able to detect some smallest level of contrast.

The method resolution

As d according to (9) does not depends on e -beam parameters, this value means not an instrument resolution but a resolution of the method itself. To distinguish between those two value we shall designate the method resolution as Δ . Let us explain this by example.

Assume that tolerable SNR is $n = 8$, dose $D = 6,25$ el/nm², $E = 0,3$ and some particle creates the contrast $C = 0,4$. Substituting this data into (9) we have $\Delta = 8,96 / 0,3 \cdot 0,4 \cdot 2,5 = 29,9$ nm. If $C = 0,2$, then $\Delta = 59,8$ nm. If we still are using the beam with 29,9 nm diameter we achieve an image with SNR $n = 4$.

Now we shall try to implement achieved formula for system optimization.

First, is possible to optimize the throughput in some range.

Assume that beam has diameter 30 nm and dose still is $D = I_b t / d^2 = 6,25$ el/nm², the product $I_b t$ is equal to 5625 electrons, so we can choose highest possible beam current (for its selected diameter), which gives us the shortest dwell time and, hence, highest throughput.

In other hand, dwell time is limited by sampling rate of analog to digital converter (ADC) and also by timing performance of applied detector. While modern ADCs have sampling rate over 100 MHz, the majority of detectors can not react with such high speed.

The fastest SE detectors which are using scintillators and PMT (called often Everhart–Thornley detector — ETD) unfortunately are not applicable here because of their size. So, leaving for a while the problem of proper detector creation, one can choose the dwell time $t = 50 \div 100$ nsec.

Then primary beam current is in the range $I = 18 \div 9$ nA.

The next possibility for optimization is improving of collection efficiency $E = (\delta \alpha)^{0,5}$.

The first coefficient δ can be increased by using beam energy close to so-called "second crossover" — the point where secondary emission yield is equal

to unity. For Si wafer this point is at the energy 2÷3 keV. Detector efficiency α improvement is also well known and consists mainly in increasing of collection angle Ω . Thus, for the best system value E is very close to unity. In comparison with above example this improves the system performance in 3 times.

An at the end, we'll point the way of improvement that rarely is in mind of e -beam system designers. This way consists in searching an experimental conditions which give an increasing the contrast C value. We have found first experimentally and then confirmed theoretically that contrast of the signal from the vertical steps depends on beam energy.

From our consideration [5] follows that contrast of the signal from the step depends on normalized height of step $h' = h/\sigma$, where σ is a size of interaction zone between e -beam and specimen. For Si wafer σ (nm) = $32 E^{5/3}$ and E expressed in keV. Here we are not discussing all the peculiarities of surface topography reconstruction which can be found in [4]. As for example, we assume that is measured signal from some small Si step with height $h = 100$ nm.

Choosing the beam energy 2 keV, we calculate that σ is about 100 nm, and from the plot in fig the signal contrast is about 2.

Now we substitute values of contrast $C = 2$ and efficiency E to formula (9) and find the resolution $\Delta_{\min} = 10/2 \cdot 2,5 = 2$ nm.

Analysis of existing systems for wafer defects inspection

First we estimate the idea of throughput increasing by irradiating the wafer with large beam

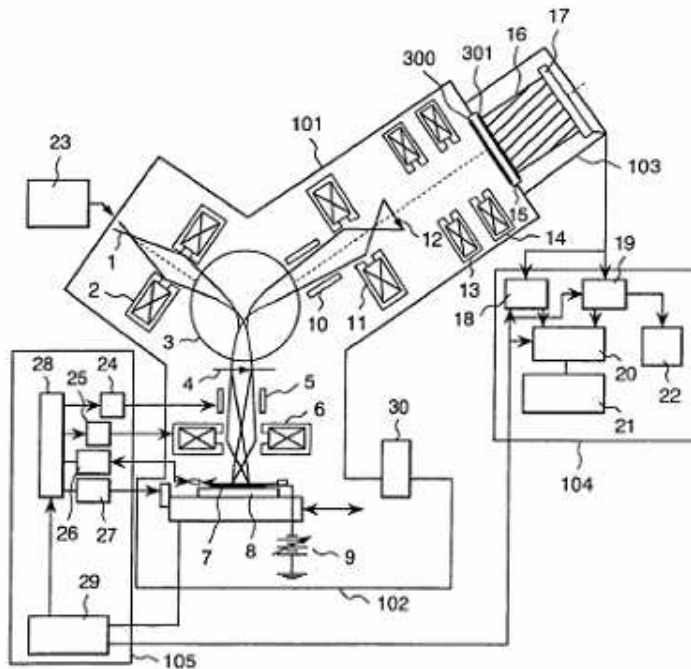

Fig. 11. A schematic view of the system for patterned wafer inspection [7]

At the fig. 11 is shown a schematic view of the system for patterned wafer inspection according to US patent #7,242, 015 B2.

The system is irradiating an area on the wafer 7 from electron source 23 via lens 2, magnetic prism 3 and focusing lens 6. For imaging is used just a portion of secondaries, namely reflected electrons (RE). REs are passing through the prism 3, Wien filter 10, magnetic lens 11 and forming an enlarged image 12 of inspected area. The image 12 can be further enlarged by lenses 13, 14 and then registered by CCD camera 17. After image of the first region is memorized then irradiating beam is moving to the next region by deflector 5.

According to the claim in one shot 50 μsec is irradiated an area 100 x 100 μm with current 100 μA . Then magnification is adjusted such a way that one pixel on CCD sensor is corresponding 0,1 μm on a specimen. Thus, the inspection speed is 2 cm^2/sec . Signal-to-noise ratio is not less then 10.

The resolution of the system is about 0,1 μm and inspection speed is 2 cm^2/sec . Leaving apart electron optics design, we shall consider just an image formation. The authors of the invention say that image of each pixel 0,1 x 0,1 μm is created by 6250 back scattered electrons (BSE). Dose of irradiation in this case is:

$$D = 6,25 \cdot 10^{18} \cdot 100 \cdot 10^{-6} \cdot 50 \cdot 10^{-6} / 10^4 = 3,125 \cdot 10^4 \text{ el}/\mu\text{m}^2.$$

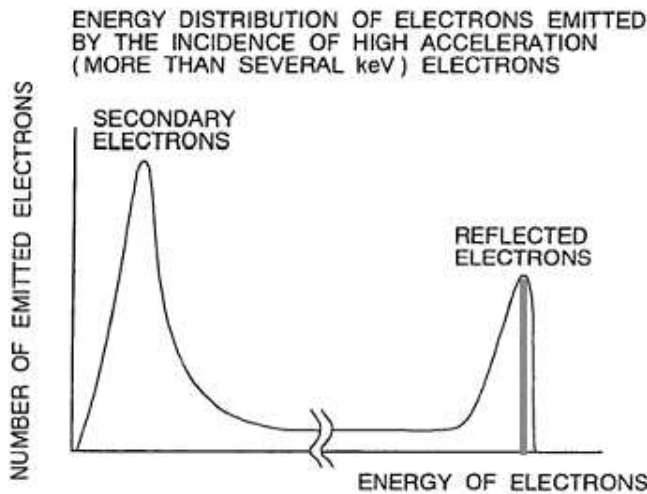

Fig. 12. The energy distribution of secondaries

If we substitute this data into equation (9), and assume $n = 10$, $C = 0,2$ and backscattering coefficient $\eta = 0,2$, then minimal size of the square, which is able to give image of desired quality is: $A = 0,125 \mu\text{m}$, what is in a good agreement with authors expectation.

However, if we would like to have a focused image it is necessary to select from the whole BSE spectra some part with energy spread a few electron volt, as it's shown schematically on fig. 12 by orange strip. Otherwise the image will be defocused because of chromatic aberration of the lens 11.

Thus, for image formation is used not $I_b \cdot \eta$ number of electrons, where $\eta = 0,2$ is backscattering coefficient, but less than one per cent of that value (fig. 11). Energy distribution of SE and BSE.

If we assume that $n = 10$, contrast is 0,2 and $E = (0,2 \cdot 0,01)^{0,5} = 1,41 \times 10^{-2}$, we achieve that the method resolution is:

$$\Delta_m = 10/0,2 \cdot 1,41 \cdot 10^{-2} \cdot (3,125 \cdot 10^4)^{0,5} = 20 \mu \text{ m}.$$

Thus, one can see that resolution is absolutely not satisfying. The saddest thing here is that is not seen how it could be improved.

Now we consider one more embodiment of defect inspection system (Fig. 13) It is a good example of both whole single beam system design and its optimization for highest possible throughput.

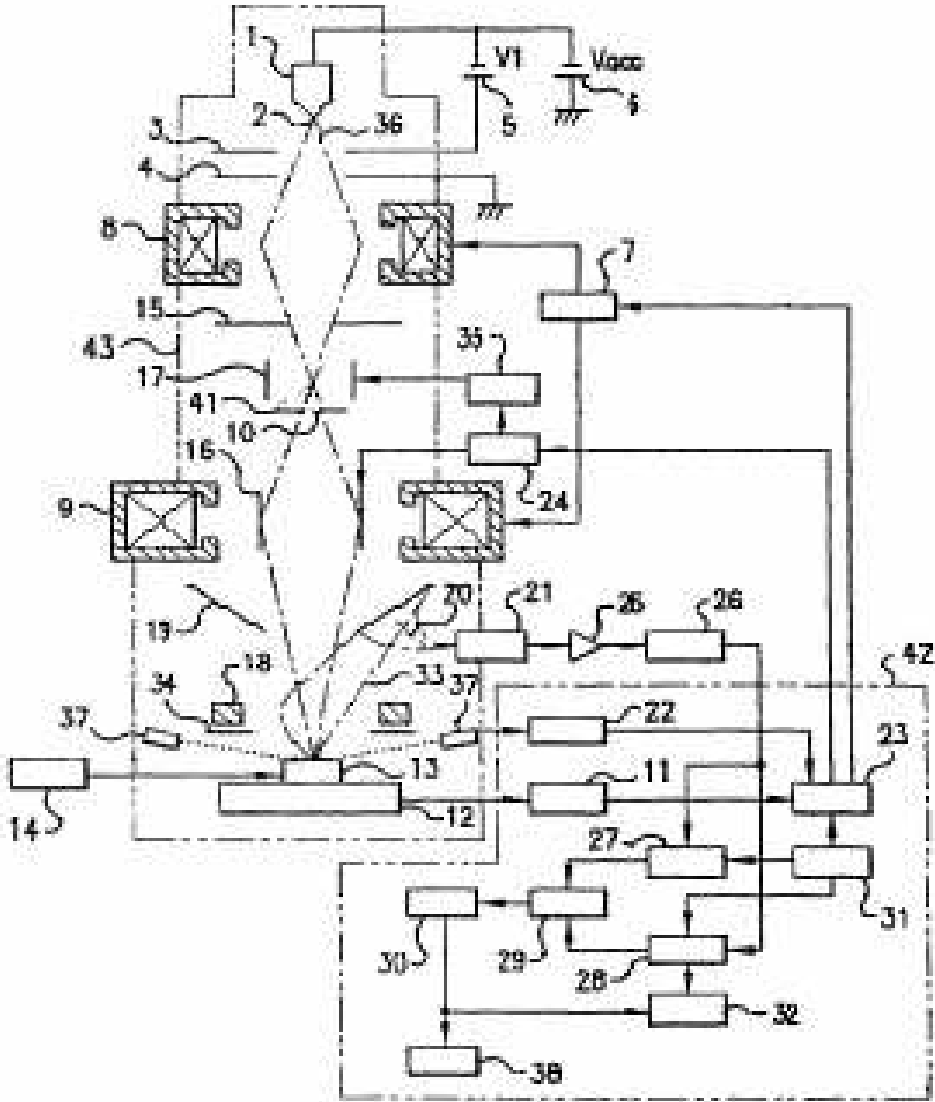

Fig. 13. The inspection system according to US patent 7,232,996 B2 [8]

The key characteristics are:

- resolution — $0,1 \mu\text{m}$;
- beam current — 100 nA;
- dwel time — 10 nsec.

Hence, current dose is $D = 6,25 \text{ el}/\mu\text{m}^2$ or $10 \mu\text{C}/\text{cm}^2$; the method resolution $\Delta = 0,14 \mu\text{m}$. However, that combination of parameters can not be improved any further.

Assume for example, that beam is focused into spot $0,05 \mu\text{m}$. Then beam current should also decrease about 25 nA, so dose remains the same. Therefore, the method resolution also does not change and image quality is getting worse. That happens because number of secondaries from pixel becomes 4 times smaller, hence SNR is 2 times lower. In order to achieve the same picture quality (but with 2 times better resolution) it is necessary to increase irradiation time since 10 nsec to 40 nsec.

Nevertheless, this system is a good example to consider all the components, not just probe forming system. Wafer stage 12 is continuously moving that allows to avoid "dead" time. The stage is equipped with a length measuring unit 11. The system is equipped with height measuring unit 37.

The discussion

Achieved relationship between signal, SNR and method resolution enables an estimation of the inspection system information capability at whole and its applicability for particular work.

In frames of existing system is possible to optimize its operational conditions (magnification, dwell time, accelerating voltage) in order to extract as much information as possible.

Analysis of existing single beam defects inspection systems shows that their practical implementation is limited by resolution $0,1 \mu\text{m}$ and this can not be improved any further by electron optical means.

The systems for topographical defect inspection in the range of 10 - 30 nm can be realized just with array of microcolumns. Fortunately, electron optics design in that range is relatively simple.

The only practical implementation for which can be really needed ultra high resolution about 2 nm is line width measuring (LWM) and microrelief profile reconstruction. However, besides an advanced electron optical design for successful application of LWM system at the inspection stage, an additional means as statistical data processing. image recognition and others similar techniques are indispensable.

References

- [1] *Frank Y.H. Fan*. Method and an apparatus for reviewing voltage contrast defects in semiconductor wafers // United States Patent. Patent No.: US 7,132,301 B1.
- [2] *V. Yunkin, M. Grigoriev, S. Kuznetsov, A. Snigirev, I. Snigireva*. Planar parabolic refractive lenses for hard x-rays: technological aspects of fabrication // Proc. of SPIE. Vol. 5539. P. 226-234.

- [3] *V.V. Aristov, N.N. Dremova, A.A. Firsova, V.V. Kazmiruk, A.V. Samsonovich, N.G. Ushakov, S.I. Zaitsev.* Signal formation of backscattered electrons by microinhomogeneities and surface relief in a SEM // Scanning. Vol. 13. (1990) P. 15-22.
- [4] *V.V. Kazmiruk, V.I. Mjasnikov, T.N. Savitskaja, I.S. Stepanov.* Attachment to SEM for local profilometry of surface // Izv. Akademii nauk SSSR. Ser. Fiz. V. 56. 3. (1992) P. 58-63.
- [5] *V.V. Kazmiruk, T.N. Savitskaja, I.S. Stepanov, A.A. Firsova.* Research of forming in SEM the backscattered electrons signal by surface microrelief // Izv. Akademii nauk SSSR. Ser. Fiz. V. 54. 2. (1990) P. 227-231.
- [6] *V.V. Kazmiruk, V.I. Mjasnikov, T.N. Savitskaja, I.S. Stepanov.* Measuring potential relief on the structures with submicron size elements // Izv. Akademii nauk SSSR. Ser. Fiz. V. 54. 2. (1990) P. 305.
- [7] *Shinada et al.* Patterned wafer inspection method and apparatus therefore // United States Patents. Patent No.: US 7,242,015 B2.
- [8] *Iwabuchi et al.* Method and an apparatus of an inspection system using an electron beam // United States Patent. Patent No.: US 7,232,996 B2.