

A DYNAMIC-BASED METHODOLOGY TO OBTAIN THE ROLLING STOCK MAXIMUM CONSTRUCTION GAUGE

Julio Álvarez . Prof. Dr. Ingeniero Industrial.

Gerente de I+D+I de RENFE – Vicepresidente y Secretario General de la A.E.C. – Sección Española – Profesor de Ingeniería Mecánica de la UC3M.

Department of Mechanical Engineering
Carlos III University, Research Institute of Vehicle Safety (ISVA)
Leganés, SPAIN

Received: November 12, 2008.

ABSTRACT

In this paper we propose a new methodology to determine the loading gauge, that has been defined as dynamic loading gauge. We take into account the different independent parameters of the complex physics phenomenon by considering the interaction force in the wheel-rail contact, by modelling the railway vehicle as a mechanic system composed of pressed on of wheels, intermediate structures and boxes connected by springs and dampers. It is also established the movement equations that define the dynamic response solving the equations by means of a software called Adams Rail.

Keywords: Dynamic loading gauge, rolling stock maximum construction gauge, vehicle dynamic, railway

1. INTRODUCTION

The experience acquired in the last 92 years, from January 1, 1914, date in which the european railway networks decided to adopt the same loading gauge (known “Passe Partout International” or PPI) has confirmed that its unification plays an important role to ensure the interoperability of the railway network in Europe. However, the continuous revisions of loading gauges that were first published on January 1, 1956, date in which the International Union of Railway (UIC) published the first sheet UIC-505 [1], until the last edition on March 1, 1997, pending of new updates, confirm that there is still no clear agreement of the procedure to obtain the envelope of the maximum dimensions that vehicles can have when they travel along the rails.

The present article analyses the loading gauge methodology according to UIC criteria. Results obtained prove that this methodology does not take in account the dynamic behaviour of the railway vehicle and, therefore, provides loading gauge values far away from the real ones. These results are endorsed from the observation of several tracks of the railway network that have worn out from the movement of the vehicles and surpapel the security margin established by the UIC. Therefore, this investigation determines a new loading gauge defined as dynamic loading gauge which takes into account the different independent parameters of the complex physics phenomenon by considering the interaction force in the wheel-rail contact, by modelling the railway vehicle as a mechanic system composed of pressed on of wheels, intermediate structures and boxes connected by springs and dampers [2][3]. We also establish the movement equations that define the dynamic response and solve these equations by means of a software called ADAMS/Rail.

2. The TRD vehicle

A TRD (Diesel Regional Train) is used in this paper to prove the proposed methodology. The TRD is a passenger train in the regional Spanish system (Figure 1). The TRD has the possibility of coupling trains (diesel and electrical traction) to be able to exploit them in partially electrified lines. The TRD has been modelled using the ADAMS/Rail computational package.



Fig. 1. The TRD vehicle

3. The kinematic gauge

The UIC 505-1 leaflet “Railway transport stock. Rolling stock construction gauge” defines the reference profile of the kinematic gauge for powered vehicles, coaches and wagons and fixes the rules associated with the reference profile of the kinematic gauge for determining the maximum construction gauge.

The maximum construction gauge is the maximum profile, obtained by applying the rules giving reductions in relation to the reference profile, which the various parts of the rolling stock must respect. These reductions depend on the geometric characteristics of the rolling stock in question, the position of the cross-section in relation to the bogie pivot or to the axles, the height of the point considered in relation to the running surface, the constructional play, the maximum wear allowance and the elastic characteristics of the suspension.

The kinematic gauge does not take into account of certain random factors (oscillations, asymmetry, if $\eta_0 \leq 1^\circ$ - see Figure 2 -) and the suspended parts of the vehicles may therefore exceed the kinematic gauge in the course of oscillation. The asymmetry of a vehicle is defined as the angle η_0 that would be formed between the vertical and the centreline of the body of a stationary vehicle on a level track in the absence of friction. Asymmetry may result from constructional defects, unevenly adjusted suspension and from an off-centre load.

The study of the maximum construction gauge takes into account both the lateral and vertical movements of the rolling stock, drawn up on the basis of the geometrical and suspension characteristics of the vehicle under various loading conditions. This gauge is determined for the middle of the vehicle and the headstocks because both of them are the most unfavourable sections.

The maximum construction gauge is obtained by the following expression:

$$\text{rolling stock maximum construction gauge} = \text{kinematic gauge} - E \quad (1)$$

where E are the reductions for the previous sections.

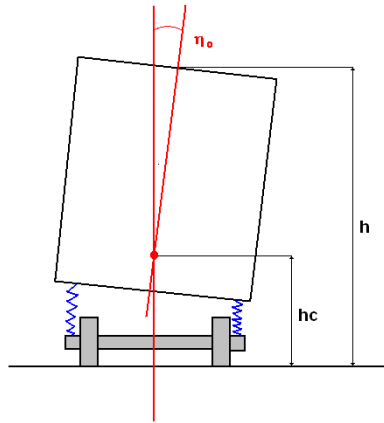

Fig. 2. The angle η_0

To ensure that a vehicle when on the track does not exceed the vehicle limit position in view of its lateral movements, the half-width dimensions must be subject to an E_i or E_a reduction, in relation to the reference profile, such that [1]:

$$E_i \text{ or } E_a = D - S \quad (2)$$

where:

- E_i : reduction value for the reference profile half-width dimensions for the sections located between the end axles of vehicles not mounted on bogies or between the pivots of vehicles mounted on bogies.
- E_a : reduction value for the reference profile half-width dimensions for the sections beyond the end axles of vehicles not mounted on bogies or the pivots of vehicles mounted on bogies.
- D represents the lateral movements. They are obtained by the following expressions in the most two unfavourable sections: middle of vehicle and headstock:

4. The rolling stock maximum construction gauge obtained for a TRD

The numerical values of a kinematic gauge for the two sections studied are drawn up in the Table 1. These values are obtained from the secondary and primary suspension values of TRD considering the UIC rules [1].

Table 1. The construction Gauge

Height, h [mm]	Kinematic gauge [mm.]	Headstock section		Middle of vehicle section	
		E_a [mm]	Construction gauge [mm]	E_i [mm]	Construction gauge [mm]
4000	1333	139.07	1193.93	147.99	1185.01
3900	1415	138.47	1276.53	148.59	1266.41
3800	1498	137.87	1360.13	149.19	1348.81
3700	1580	137.27	1442.73	149.79	1430.21

3600	1615	136.67	1478.33	150.39	1464.61
3500	1650	136.07	1513.93	150.99	1499.01
3400	1685	135.47	1549.53	151.59	1533.41
3300	1720	134.87	1585.13	152.19	1567.81
3200	1720	134.27	1585.73	152.79	1567.21
3100	1720	133.67	1586.33	153.39	1566.61
3000	1720	133.07	1586.93	153.99	1566.01
2900	1720	132.47	1587.53	154.59	1565.41
2800	1720	131.87	1588.13	155.19	1564.81
2700	1720	131.27	1588.73	155.79	1564.21
2600	1720	130.67	1589.33	156.39	1563.61
2500	1720	130.07	1589.93	156.99	1563.01
2400	1720	129.47	1590.53	157.59	1562.41
2300	1720	128.87	1591.13	158.19	1561.81
2200	1720	128.27	1591.73	158.79	1561.21
2100	1720	127.67	1592.33	159.39	1560.61
2000	1720	127.07	1592.93	159.99	1560.01
1900	1720	126.47	1593.53	160.59	1559.41
1800	1720	125.87	1594.13	161.19	1558.81
1700	1720	125.27	1594.73	161.79	1558.21
1600	1720	124.67	1595.33	162.39	1557.61
1500	1720	124.07	1595.93	162.99	1557.01
1400	1720	123.47	1596.53	163.59	1556.41
1300	1720	122.87	1597.13	164.19	1555.81
1200	1720	122.27	1597.73	164.79	1555.21
1100	1695	121.67	1573.33	165.39	1529.61
1000	1695	121.07	1573.93	165.99	1529.01

5. New methodology for the rolling stock maximum construction gauge. The dynamic gauge

The previous methodology does not take in account the dynamic behaviour of the railway vehicle and, therefore, provides construction gauge values far away from the real ones. In this paper, the vehicle dynamic is considered to calculate the construction gauge using the results obtained from ADAMS/Rail. In this case, we follow the UIC recommendations which indicate that the considered displacements to obtain the gauge have to be the maximum values.

In this case, only the values of lateral play between axle and bogie frame (q), play of bogie pivots or bolsters (w) and quasi-static movement (z) depend on the vehicle dynamic. In this case, the quasi-static movement is designated as dynamic movement. These values are obtained from the simulations.

The lateral play between axle and bogie frame (q) is obtained from the displacements of the primary suspension. These displacements are shown in Figures 3 and 4. The maximum displacement is produced in the right wheel of the rear wheelbase of the front bogie and its value is $q=2.5\text{ mm}$.

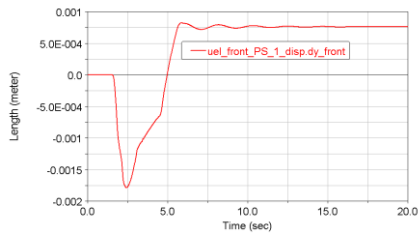

a) Left wheel of front wheelbase

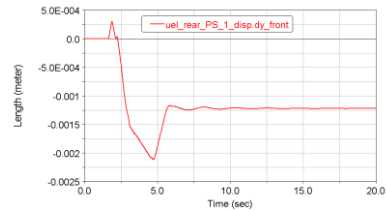

b) Left wheel of rear wheelbase

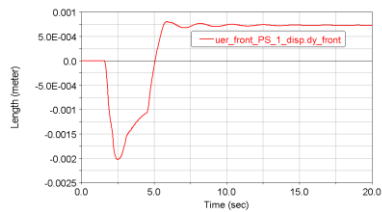

c) Right wheel of front wheelbase

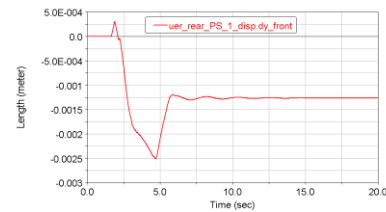

d) Right wheel of rear wheelbase

Fig. 3. Primary suspension displacements of the front bogie

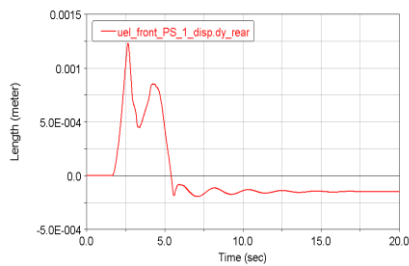

a) Left wheel of front wheelbase

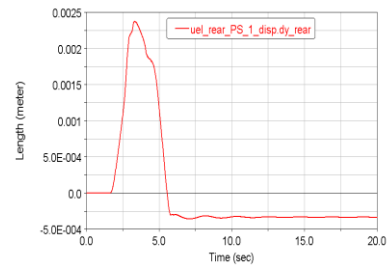

b) Left wheel of rear wheelbase

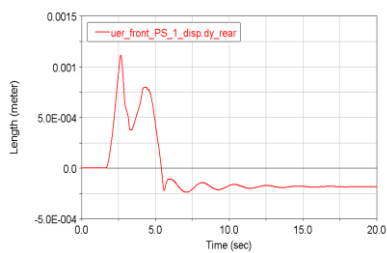

c) Right wheel of front wheelbase

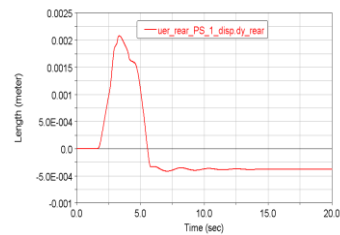

d) Right wheel of rear wheelbase

Fig. 4. Primary suspension displacements of the rear bogie

The play of bogie pivots (w) is obtained from the displacements of the secondary suspension. These displacements are shown in Figures 5 and 6. The maximum displacement is produced in the left element of the front bogie and its value is $w = 19.6 \text{ mm}$.

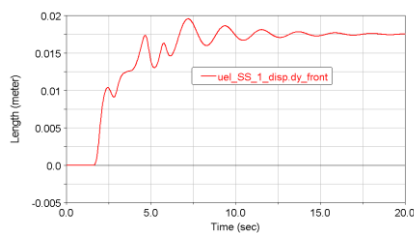

a) Left element

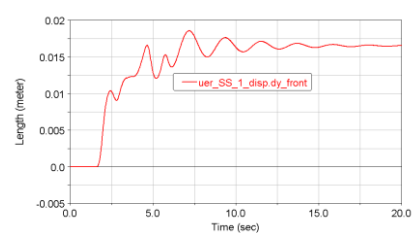

b) Right element

Fig. 5. Secondary suspension displacements of the front bogie

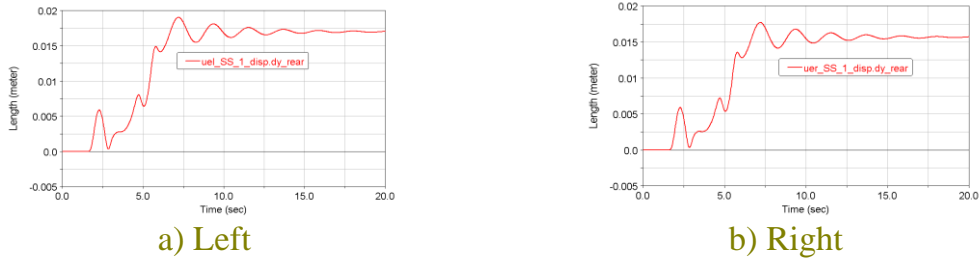

a) Left b) Right
 Fig. 6. Secondary suspension displacements of the rear bogie

The dynamic movement is obtained from the following equation (z):

$$z_i = z_a = \text{tag}(\eta) \cdot (h - h_c) \quad (3)$$

where h is the body height (h_c) is the height of the roll centre and η is angle between the vehicle body and the perpendicular to the rail level (figure 7):

$$\eta = \delta - \theta \quad (4)$$

δ is the cant angle:

$$\delta = \text{arctg}\left(\frac{\text{cant}}{1}\right) = \text{arctg}\left(\frac{160}{1735}\right) = 5.27^\circ \quad (5)$$

and θ is the body roll angle which is obtained from the simulations (figure 8). The maximum value is $\theta = 5^\circ$:

$$\eta = \delta - \theta = 5.27 - 5 = 0.27^\circ \quad (6)$$

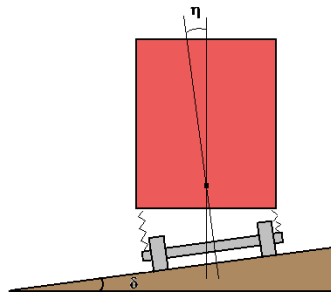

Fig. 7. Angle between the vehicle body and the perpendicular to the rail level

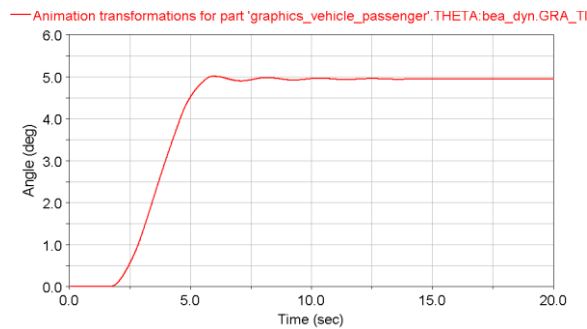

Fig. 8. The body roll angle

6. The dynamic construction gauge obtained for a TRD

The numerical values of kinematic gauge for the two sections studied are drawn up in the Table 2.

Table 2. The construction Gauge

Headstock section			Middle of vehicle section		
Height, h [mm]	Kinematic gauge [mm.]	E _a [mm]	Height, h [mm]	Kinematic gauge [mm.]	E _a [mm]
4000	1333	145.08	1187.92	158.62	1174.8
3900	1415	144.61	1270.39	159.09	1255.91
3800	1498	144.14	1353.86	159.56	1338.44
3700	1580	143.67	1436.33	160.03	1419.97
3600	1615	143.2	1471.8	160.5	1454.5
3500	1650	142.73	1507.27	160.97	1489.03
3400	1685	142.26	1542.74	161.44	1523.56
3300	1720	141.79	1578.21	161.91	1558.09
3200	1720	141.42	1578.58	162.38	1557.62
3100	1720	140.85	1579.15	162.85	1557.15
3000	1720	140.38	1579.62	163.32	1556.68
2900	1720	139.91	1580.09	163.79	1556.21
2800	1720	139.44	1580.56	164.26	1555.74
2700	1720	138.97	1581.03	164.73	1555.27
2600	1720	138.5	1581.5	165.2	1554.8
2500	1720	138.03	1581.97	165.67	1554.33
2400	1720	137.56	1582.44	166.14	1553.86
2300	1720	137.09	1582.91	166.61	1553.39
2200	1720	136.62	1583.38	167.08	1552.92
2100	1720	136.15	1583.85	167.55	1552.45
2000	1720	135.68	1584.32	168.02	1551.98
1900	1720	135.21	1584.79	168.49	1551.51
1800	1720	134.74	1585.26	168.96	1551.04
1700	1720	134.27	1585.73	169.43	1550.57
1600	1720	133.8	1586.2	169.9	1550.1
1500	1720	133.33	1586.67	170.37	1549.63
1400	1720	132.86	1587.14	170.84	1549.16
1300	1720	132.39	1587.61	171.31	1548.69
1200	1720	131.92	1588.08	171.78	1548.22
1100	1695	131.45	1563.55	172.25	1522.75
1000	1695	130.98	1564.02	172.72	1522.28

7. Conclusions

In this paper we proposed a new methodology to determine the construction gauge considering the vehicle dynamics. For this reason, this gauge is called dynamic construction gauge. The dynamic gauge is obtained from results of simulations using the ADAMS/Rail software.

Comparing the results between the construction gauge and the dynamic construction gauge, it is observed that the dynamic gauge is 13% and 3% greater than the traditional gauge in the middle vehicle section and the headstock section respectively. The proposed methodology is more restrictive than the other since it considers the vehicle dynamics.

Moreover, our methodology follows the recommendations the UIC.

References

- [1] Ficha UIC 505-5 (1993) Condiciones de base fichas 505-1 505-4.
- [2] J.K. Hedrick, D.N. Wormley et al. Non-linear analysis and design tools for rail vehicles. Non-linear Locomotive Dynamics, ARR Report R-463. 1980.
- [3] K. Knothe and L. Hung. Wear for the wheel-rail rolling contact problem. O. Nordstrom Dynamics of Vehicles on Roads and Tracks, Proc. 9th IA VSD Symposium. pp. 264-277. 1986.