

# Electric and Spectroscopic Characterization of Magnetized Hydrogen and Helium Hot Cathode Discharge Plasma

Milan ČERČEK<sup>1,2,4</sup>, Tomaž GYERGYEK<sup>1,3,4</sup> and Boris FONDA<sup>1</sup>

<sup>1</sup>Jožef Stefan Institute, Jamova 39, 1000 Ljubljana, Slovenia

<sup>2</sup>Faculty of Civil Engineering, University of Maribor, Smetanova 17, 2000 Maribor, Slovenia

<sup>3</sup>Faculty of Electrical Engineering, University of Ljubljana, Tržaška 25, 1000 Ljubljana, Slovenia

<sup>4</sup>Association EURATOM/MHEST

Codrina IONIȚĂ, and Roman SCHRITTWIESER

Institute for Ion Physics and Applied Physics, Leopold-Franzens University of Innsbruck, A-6020 Innsbruck, Austria  
Association EURATOM/ÖAW

(Received: 1 September 2008 / Accepted: 23 January 2009)

The role of hydrogen atoms and molecules as well as helium atoms in boundary plasmas is currently being very thoroughly investigated [1]. In this contribution we present the characteristic properties of magnetized hydrogen and helium plasma measured with diagnostic techniques which are readily available in divertor plasma simulators [2] and in smaller experimental fusion devices [3].

Keywords: plasma potential, electron temperature, Langmuir probe, emissive probe, emission spectroscopy, hydrogen plasma, Fulcher band spectra.

## 1. Introduction

Recently, linear magnetized hydrogen plasmas are widely used to simulate boundary or divertor plasma conditions in fusion experiments. In such simulators basic plasma-wall interaction mechanisms and turbulent plasma transport across the magnetic field can be studied successfully. Similarly, simple plasma and neutral gas diagnostic techniques can be improved or new methods developed and tested. Our intention is to adapt our plasma machine for such studies and to investigate novel probe and spectroscopic techniques in more complex boundary-like plasmas.

The linear magnetized plasma machine at the Jožef Stefan Institute in Ljubljana (Figure 1) consists of two chambers, a source chamber and an experimental chamber. The source chamber is mounted in the region of weak diverging magnetic field. The experimental chamber has a diameter of 17 cm, is 1.5 m long and is mounted in the tunnel of 14 magnetic coils, which can produce a linear magnetic field from 0.01 T up to 0.4 T. Plasma is generated by a hot cathode discharge between ten heated tungsten wires and the source wall. The thoriated wires are 0.2 mm thick and 10 cm long, connected in parallel and heated with 40A heating current to the emitting temperature. The emitted electrons are accelerated with a discharge voltage of 50 V. The plasma column in the experimental region has a diameter of 2.5 cm and is terminated by a floating or

biased end plate. A typical length of the plasma column is 1 m.

The plasma parameters and their profiles, such as density, potential and electron temperature are measured by movable cylindrical Langmuir probe, while possible particle drifts can be determined by a double sided planar Langmuir probe. The plasma potential is also recorded by an emissive probe. Special probe systems or antennas have been used in the past to measure the properties of the ion acoustic resonance cones and the ion acoustic wave propagation. From measured data the values of various plasma parameters can be deduced.

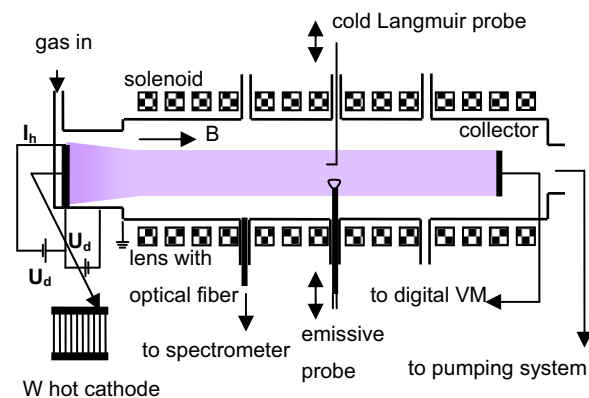

Fig.1 The scheme of the linear magnetized plasma machine with the hot cathode plasma source.

milan.cercek@ijs.si

## 2. Electric characterization

In order to further enhance the plasma-atom (molecule) interaction we made a minor modification of

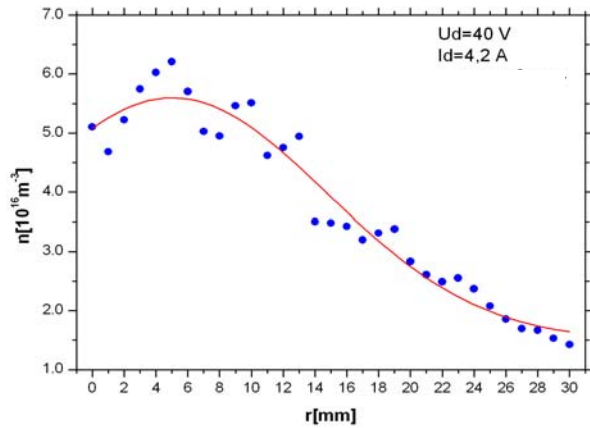

Fig.2 The radial profile of hydrogen plasma density measured at an axial distance of 60 cm from the cathode. The center of the plasma column is at  $r = 5$  mm.

the plasma source. Plasmas with relatively high densities are now easily obtained. We measured the plasma parameters with a cylindrical Langmuir probe. In Figure 2

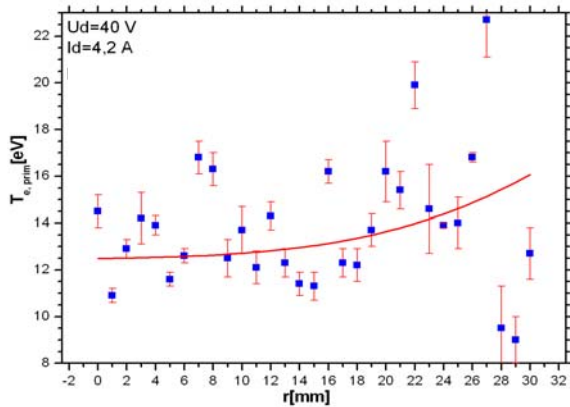

Fig.3 The radial profile of the primary electron temperature at the same axial distance.

the plasma density profile is shown for a hydrogen discharge at  $P = 0.15$  Pa and discharge current of  $I_d = 4.2$  A. The central density value is  $n = 6 \times 10^{16} \text{ m}^{-3}$ . The plasma column is rather large, at 4 cm diameter the density is still above  $n = 1 \times 10^{16} \text{ m}^{-3}$ . The electron component of the plasma was found to be composed of two electron populations: of primary electrons emitted and accelerated from the hot cathode and of secondary electrons produced by the impact ionization of hydrogen gas. They were obtained by fitting the measured probe characteristics from which the ion saturation current was subtracted with a bi-Maxwellian electron velocity distribution function. Their typical temperatures were  $T_{e,prim} = 13$  eV and  $T_{e,sec} = 5 - 2$  eV, respectively. Radial profiles of both temperatures

are shown in Figures 3 and 4. The plasma potential is radially decreasing indicating the radial confinement of

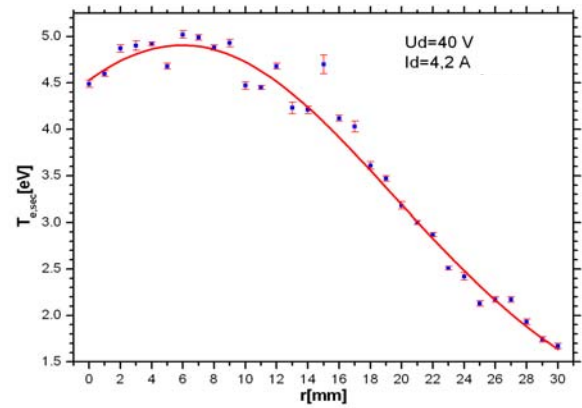

Fig.4 The radial profile of the secondary electron temperature at the same axial distance.

less magnetized ions (Figure 5). In the plots of plasma density and plasma potential profiles one can observe certain structures which are due to the inhomogeneous

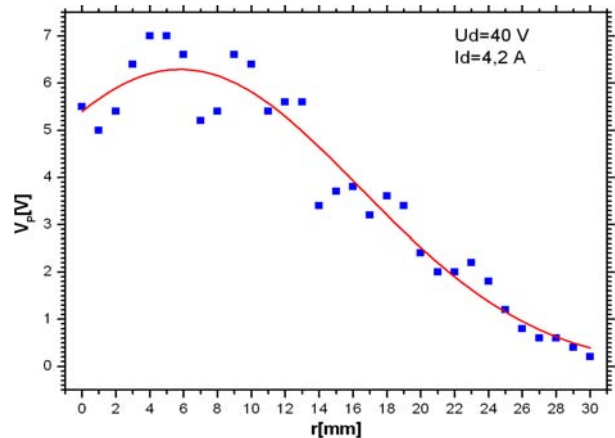

Fig.5 The radial profile of the plasma potential at the same axial distance.

production of plasma at the cathode. The W wires are mounted in a weak magnetic field and the emitted electrons are confined in sheets along the field lines and therefore producing a partially inhomogeneous plasma column. We intend in the near future to replace the existing cathode by a planar LaB<sub>6</sub> electron emitter. We are building a gas feeding station with two lines in order to enable experiments in plasmas with two ion species which are fusion relevant (He, H<sub>2</sub>/D<sub>2</sub>) or to puff in hydrogen gas at a different locations than near the plasma source. In this respect also a special source of vibrationally excited hydrogen molecules has been constructed.

## 3. Spectroscopic characterization

We have introduced the atomic and molecular

emission spectroscopic characterization of hydrogen/helium plasma. For this purpose we purchased a new dual-channel fiber-optic AvaSpec-2048TEC-USB2 (Avantes) spectrometer. Both spectrometer channels have an optical bench with a 75-mm focal length, developed in a symmetrical Czerny-Turner design. The channels are equipped with high speed CCD detectors with 2048 pixels to support the high sensitivity and the optical resolution. In



Fig.6 In-vacuum fiber probe for spectroscopic measurements.

order to improve the dynamic range and to reduce the dark noise each CCD is mounted on a single-stage Peltier cooling device. One of the channels is devoted to the broad visible spectrum measurements (360 nm – 860 nm) with grating of 600 lines/mm and a 25- $\mu\text{m}$  entrance slit. The second one is devoted to the study of hydrogen molecular spectra (Fulcher band: 595 nm – 645 nm). It is equipped with grating of 2400 lines/mm and also has an entrance slit of 25  $\mu\text{m}$ . The optical resolution of the narrow channel is 0.09 nm. The light-collection system has a collimating lens at the end of a 600- $\mu\text{m}$  fiber-optic cable. To enhance the collection of light from the plasma column an in-vacuum fibre probe (Figure 6) was built, using a special vacuum feedthrough.

A typical hydrogen-emission spectrum from a pure hydrogen plasma produced at a pressure  $3 \times 10^{-2}$  Pa is shown in Figure 7. One can clearly observe the atomic Balmer lines  $H_{\alpha}$ ,  $H_{\beta}$ ,  $H_{\delta}$ ,  $H_{\gamma}$  and the molecular Fulcher band from 600 nm to 640 nm. The discharge current in this particular case was  $I_d = 1\text{A}$ .

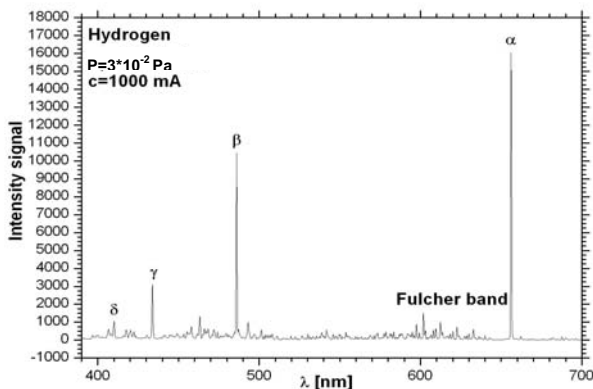

Fig.7 The emission spectrum measured in hydrogen plasma.

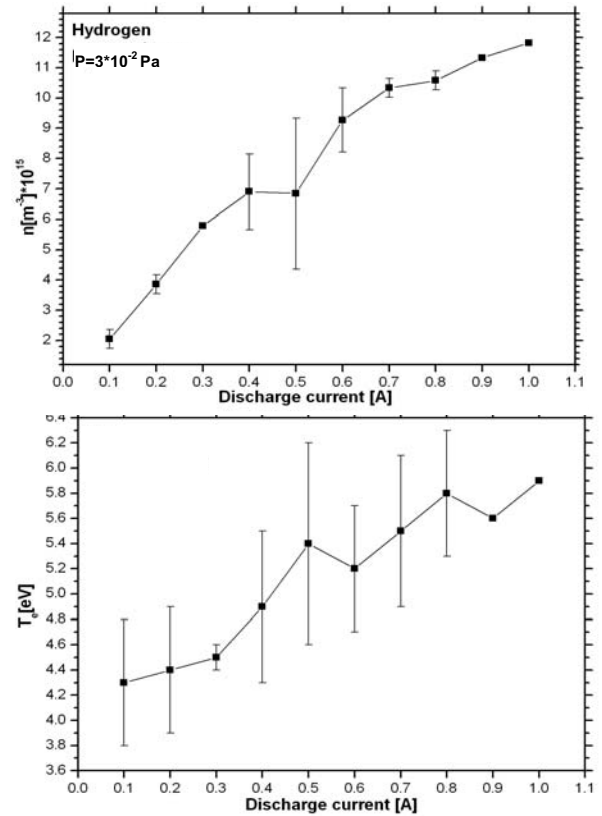

Fig.8 Plasma density  $n$  and electron temperature  $T$  increase with the discharge current.

The plasma parameters, such as plasma density and electron temperature, are closely related to the discharge current which can be directly controlled by the heating current through the cathode wires. The results of our measurements obtained with the Langmuir probe are shown in Figure 8. We have therefore investigated the behavior of the emission spectra as a function of the discharge current. In Figure 9 the intensity of the atomic

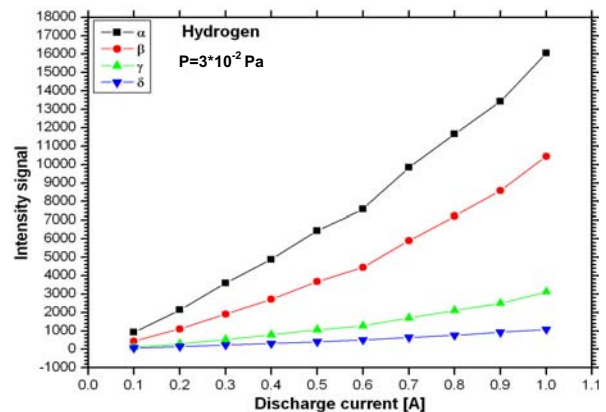

Fig.9 The intensity of atomic hydrogen spectral lines increases with discharge current.

hydrogen lines is plotted against the discharge current. The intensity of all lines increases with increasing discharge current which is in accordance with the increasing electron

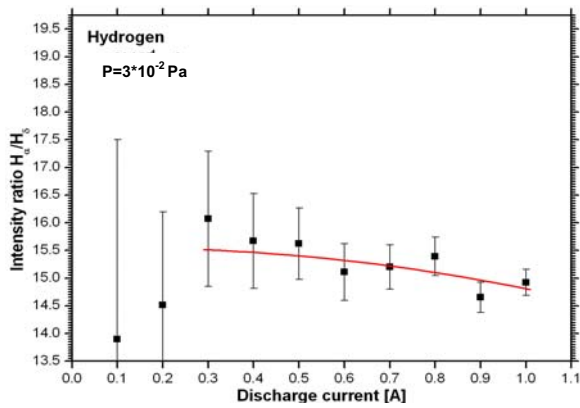

Fig.10 The intensity ratio  $H_\alpha/H_\delta$  slightly decreases with increasing discharge current.

density and temperature. The measurements were performed at various working pressures and the result was the same.

The line ratio methods are used to determine various plasma parameters and very recently it was used also for determination of negative hydrogen ion densities [4]. In order to start such investigations we have studied preliminarily the dependence of the line ratios on the discharge current. For two values of the working pressure the line ratios  $H_\alpha/H_\beta$  and  $H_\beta/H_\gamma$  were found to be similar, whereas the line ratio  $H_\alpha/H_\delta$  is constant or slightly decreasing with increasing discharge current as it can be observed in Figure 10. In weaker plasma some departure from this behavior was observed and it will be investigated in future. The influence of relevant plasma parameters on the emission rate for excitation for  $H_\delta$  and eventual consequences for diagnostics has not been considered yet in more detail.

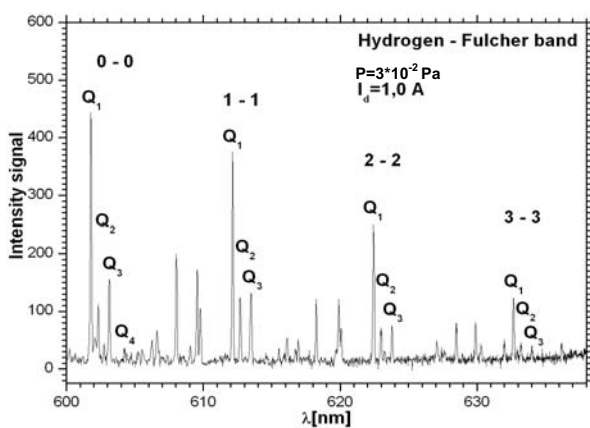

Fig.11 Observed Fulcher band spectra in hydrogen plasma. The lines of the diagonal vibrational Q branch are labeled.

The emission spectrum in the range of the molecular Fulcher band measured under the same experimental conditions as the above spectrum in the broad visible range is shown in Figure 11. The intensity variation with discharge current was also studied and similar results as for atomic Balmer lines were obtained. The Fulcher band spectrum is used for determining the vibrational and rotational temperature of ground state hydrogen molecules present in the plasma, as well as indirectly also for determination of gas temperature. The use of appropriate models is now under investigation.

#### 4. Conclusion

We have performed introductory measurements of various parameters in hydrogen/helium plasma in a linear magnetized plasma machine. The plasma system is intended for basic studies of hydrogen interaction with material surfaces, especially of vibrationally excited molecules. For this reason a new diagnostic system for Fulcher band spectroscopy was installed at the machine. In parallel we are introducing a seldom used method for measuring the electron temperature with a floating emissive probe. In this case, the bi-Maxwellian nature of the electron distribution function should be carefully taken into account.

#### 5. References

- [1] A. Pospieszczyk, S. Brezinsek, Ph. Martens, G. Sergienko, *Contrib. Plasma Phys.* **42** (2002) 663-667.
- [2] A. Matsubara, T. Sugimoto, T. Shibuya, K. Kawamura, S. Sudo, K. Sato, *J. Nucl. Mater.* **313-316** (2003) 720-724.
- [3] R. Schrittwieser, C. Ioniță, P. Balan et al., *Plasma Phys. Control. Fusion* **50** (2008) 055004.
- [4] U. Fantz, D. Wunderlich, *New Journal of Phys.* **8** (2006) 301.

#### Acknowledgement

This work, supported by the European Communities under the contract of Associations between EURATOM and MHEST and EURATOM and ÖAW was carried out within the framework of the European Fusion Development Agreement. The content of the publication is the sole responsibility of its author(s) and it does not necessarily represent the views of the Commission or its services. This work was also supported by projects J2-7535 of the Slovenian Research Agency, L302-N02 of the Austrian Science Fund and the Excellentia Programme for graduated women of the University of Innsbruck.

The authors would like to thank the referee for valuable comments and suggestions.