

Backstepping sliding mode controller improved with fuzzy logic: Application to the quadrotor helicopter

SAMIR ZEGHLACHE, DJAMEL SAIGAA, KAMEL KARA, ABDELGHANI HARRAG
and ABDERRAHMEN BOUGUERRA

In this paper we present a new design method for the flight control of an autonomous quadrotor helicopter based on fuzzy sliding mode control using backstepping approach. Due to the underactuated property of the quadrotor helicopter, the controller can move three positions (x, y, z) of the helicopter and the yaw angle to their desired values and stabilize the pitch and roll angles. A first-order nonlinear sliding surface is obtained using the backstepping technique, on which the developed sliding mode controller is based. Mathematical development for the stability and convergence of the system is presented. The main purpose is to eliminate the chattering phenomenon. Thus we have used a fuzzy logic control to generate the hitting control signal. The performances of the nonlinear control method are evaluated by simulation and the results demonstrate the effectiveness of the proposed control strategy for the quadrotor helicopter in vertical flights.

Key words: fuzzy sliding mode, backstepping, quadrotor helicopter, dynamic modeling, underactuated systems

1. Introduction

Autonomous unmanned air vehicles (UAV) are increasingly popular platforms, due to their use in military applications, traffic surveillance, environment exploration, structure inspection, mapping and aerial cinematography, in which risks to pilots are often high. Rotorcraft has an evident advantage over fixed-wing aircraft for various applications because of their vertical landing/take-off capability and payload. Among the rotorcraft, quadrotor helicopters can usually afford a larger payload than conventional helicopters due to four rotors. Moreover, small quadrotor helicopters possess a great maneuverability and are potentially simpler to manufacture. For these advantages, quadrotor helicopters have received much interest in UAV research [1].

The quadrotor is an underactuated system with six outputs and four inputs, and the states are highly coupled. Great efforts have been made to control quadrotor helicopter

S. Zeghlache, D. Saigaa, A. Harrag and A. Bouguerra are with LASS Laboratory, Department of Electronics, Faculty of Technology, University of Msila, BP 166 Ichbilia 28000 Algeria. E-mails: zeghlache_samir@yahoo.fr, saigaa_dj@yahoo.fr, abdelghani.harrag@gmail.com, rah.bou@yahoo.fr. K. Kara is with Department of Electronics, Faculty of Engineering Sciences, University of Blida.

Received 24.01.2012. Revised 01.07.2012

and some strategies have been developed to solve the path following problems for this type of system. In the first works, the quadrotor has been controlled in 3 degree of freedom (DOF). The authors of [2] take into account the gyroscopic effects and show that the classical independent PD controller can stabilize asymptotically the attitude of the quadrotor aircraft. Moreover, they used a new Lyapunov function, which leads to an exponentially stabilizing controller based upon PD2 and the compensation of coriolis and gyroscopic torques. In [3] the authors develop PID controller in order to stabilize altitude. In [4] PID controller and LQ controller were proposed to stabilize the attitude. The PID controller showed the ability to control the attitude in the presence of minor perturbation and the LQ controller provided average results. In [5] the authors used the combination of the backstepping technique and a nonlinear robust PI controller. The integral action gain is nonlinear and bases on a switching function which ensures a robust behavior for the overall control law. In [6] the backstepping fuzzy logic controller (BFL) is proposed as well as the backstepping least mean square controller (BLMS), as new approaches to control the attitude and stabilize of the quadrotor UAV.

There are number of papers where a control of the quadrotor in 6 DOF is presented. First of all, several backstepping and feedback linearization controllers have been developed. In [7] a full-state backstepping technique based on the Lyapunov stability is studied. In [8] it is presented the nonlinear control techniques which is applied to the autonomous micro helicopter type quadrotor using the backstepping approach. Reference [9] presents different control architectures such as feedback linearization and backstepping method to control the quadrotor. The architecture bases on visual feedback as the primary sensor. In [10] it is presented the backstepping approach for controlling a quadrotor using Lagrange form dynamics. Two neural networks are introduced to estimate the aerodynamic components, one for aerodynamic forces and one for aerodynamic moments. In [11] a mixed robust feedback linearization with linear GH_∞ controller is applied to a nonlinear quadrotor UAV. In [12] the control strategy includes feedback linearization coupled with PD controller for the translational subsystem and backstepping-based PID nonlinear controller for the rotational subsystem of the quadrotor. There is another non linear control technique applied to the quadrotor such as in [13], namely robust adaptive-fuzzy control. This controller showed a good performance against sinusoidal wind disturbance. In [14] it is presented the comparison between model-based methods and a fuzzy inference system to control a drone. The authors of [15] present integral predictive and nonlinear H_∞ control strategy to solve the path following problem for the quadrotor helicopter.

The sliding mode control has been tested extensively to control quadrotors. The advantage of this approach is its insensitivity to the model errors and parametric uncertainties, as well as the ability to globally stabilize the system in the presence of other disturbances [16]. In [17] it is used the sliding mode approach to control a class of underactuated systems (quadrotor). In [18] the authors present continuous sliding mode control method based on feedback linearization applied to the quadrotor. New controller based on backstepping and sliding mode techniques for miniature quadrotor helicopter is presented in [8, 19]. [1] presents two types of nonlinear controllers for an autonomous

quadrotor helicopter. First type, a feedback linearization controller involves high-order derivative terms and turns out to be quite sensitive to sensor noise as well as modeling uncertainty. The second type involves a new approach to an adaptive sliding mode controller using input augmentation in order to account for the underactuated property of the helicopter.

This contribution bases on the combination of the backstepping sliding mode and fuzzy logic technique in order to eliminate the chattering phenomenon. We present a control technique based on the development and the synthesis of a control algorithm which bases upon sliding mode and ensures the locally asymptotic stability and desired tracking trajectories expressed in term of the centre of mass coordinates along (x, y, z) axis and yaw angle, while the desired roll and pitch angles are deduced unlike to [8]. Finally all synthesized control laws are highlighted by simulations providing satisfactory results.

2. Quadrotors dynamics modeling

A quadrotor helicopter is a highly nonlinear, multivariable, strongly coupled, and underactuated system with six degrees of freedom (6 DOF) and 4 actuators. The main forces and moments acting on the quadrotor are produced by propellers. There are two pairs of propellers in the system rotating in opposite direction to balance the total torque of the system. Changing the second and the fourth propeller's speed conversely produces roll rotation coupled with lateral motion. Pitch rotation and the corresponding lateral motion result from the first and the third propeller's speed conversely modified. Yaw rotation is more subtle, as it results from the difference in the counter-torque between each pair of propellers.

Let $E(O, x, y, z)$ denote an inertial frame, and $B(O', x, y, z)$ denote a frame rigidly attached to the quadrotor as shown in Fig. 1

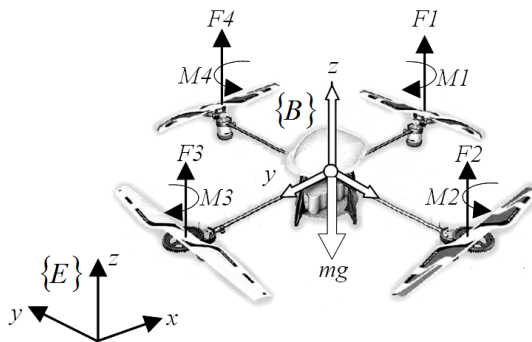

Figure 1. Quadrotor configuration.

The following assumptions are undertaken:

- The quadrotor's structure is rigid and symmetrical.
- The center of mass and O' coincide.
- The propellers are rigid.
- Thrust and drag are proportional to the square of the propellers speed.

Under these assumptions, it is possible to describe the fuselage dynamics as that of a rigid body in space to which come to be added the aerodynamic forces caused by the rotation of the rotors. Using the formalism of Newton-Euler, the dynamic equations are written in the following form:

$$\begin{cases} \dot{\zeta} = v \\ m\ddot{\zeta} = F_f + F_g \\ \dot{R} = R S(\Omega) \\ J\dot{\Omega} = -\Omega \wedge J\Omega + \Gamma_f - \Gamma_g \end{cases} \quad (1)$$

where ζ is the position of the quadrotor center of mass with respect to the inertial frame, m is the total mass of the structure and $J \in \mathfrak{R}^{3 \times 3}$ is a symmetric positive definite constant inertia matrix of the quadrotor with respect to B :

$$J = \begin{pmatrix} I_x & 0 & 0 \\ 0 & I_y & 0 \\ 0 & 0 & I_z \end{pmatrix}. \quad (2)$$

Ω is the angular velocity of the airframe expressed in B :

$$\Omega = \begin{pmatrix} 1 & 0 & -\sin\theta \\ 0 & \cos\varphi & \cos\theta \sin\varphi \\ 0 & -\sin\varphi & \cos\varphi \cos\theta \end{pmatrix} \begin{pmatrix} \dot{\phi} \\ \dot{\theta} \\ \dot{\psi} \end{pmatrix}. \quad (3)$$

If the quadrotor performs many angular motions of low amplitude, Ω can be assimilated to $[\dot{\phi}, \dot{\theta}, \dot{\psi}]^T$. R is the homogenous matrix transformation as follows

$$R = \begin{pmatrix} c\theta c\psi & c\psi s\theta s\varphi - s\psi c\varphi & c\psi s\theta s\varphi - s\psi c\varphi \\ c\theta s\psi & s\psi s\theta s\varphi + c\psi c\varphi & s\psi s\theta c\varphi - c\psi s\varphi \\ -s\theta & s\varphi c\theta & c\varphi c\theta \end{pmatrix} \quad (4)$$

where c and s indicate the trigonometric functions \cos and \sin respectively. $S(\Omega)$ is a skew-symmetric matrix. For a given vector $\Omega = [\Omega_1 \ \Omega_2 \ \Omega_3]^T$ it is defined as follows:

$$S(\Omega) = \begin{pmatrix} 0 & -\Omega_3 & \Omega_2 \\ \Omega_3 & 0 & -\Omega_1 \\ -\Omega_2 & \Omega_1 & 0 \end{pmatrix}. \quad (5)$$

F_f is the resultant of the forces generated by the four rotors:

$$F_f = \begin{pmatrix} \cos \varphi \cos \psi \sin \theta + \sin \varphi \sin \psi \\ \cos \varphi \sin \psi \sin \theta - \sin \varphi \cos \psi \\ \cos \varphi \cos \theta \end{pmatrix} \sum_{i=1}^4 F_i \quad (6)$$

$$F_i = b \omega_i^2 \quad (7)$$

where b is the lift coefficient and ω_i is the angular rotor speed. F_i is the resultant of the drag forces along (x, y, z) axis

$$F_i = \begin{pmatrix} -K_{ftx} & 0 & 0 \\ 0 & -K_{f ty} & 0 \\ 0 & 0 & -K_{ftz} \end{pmatrix} \zeta \quad (8)$$

where $K_{ftx}, K_{f ty}, K_{ftz}$ are the translation drag coefficients. F_g is the gravity force

$$F_g = [0 \ 0 \ -mg]^T. \quad (9)$$

Γ_f is the moment developed by the quadrotor according to the body fixed frame. It is expressed as follows:

$$\Gamma_f = \begin{pmatrix} l (F_3 - F_1) \\ l (F_4 - F_2) \\ d (\omega_1^2 - \omega_2^2 + \omega_3^2 - \omega_4^2) \end{pmatrix} \quad (10)$$

where l is the distance between the quadrotor center of mass and the rotation axis of propeller and d is the drag coefficient. Γ_a is the resultant of aerodynamics frictions torques:

$$\Gamma_a = \begin{pmatrix} K_{fax} & 0 & 0 \\ 0 & K_{f ay} & 0 \\ 0 & 0 & K_{faz} \end{pmatrix} \Omega^2 \quad (11)$$

where $K_{fax}, K_{f ay}, K_{faz}$ are the frictions aerodynamics coefficients. Γ_g is the resultant of torques due to the gyroscopic effects:

$$\Gamma_g = \sum_{i=1}^4 \Omega \wedge J_r \begin{bmatrix} 0 \\ 0 \\ (-1)^{i+1} \omega_i \end{bmatrix} \quad (12)$$

where J_r is the rotor inertia. Consequently the complete dynamic model which governs the quadrotor is as follows:

$$\left\{ \begin{array}{l} \ddot{\phi} = \frac{1}{I_x} \{ \dot{\theta} \dot{\psi} (I_y - I_z) - K_{fax} \dot{\phi}^2 - J_r \bar{\Omega} \dot{\theta} + l U_2 \} \\ \ddot{\theta} = \frac{1}{I_y} \{ \dot{\phi} \dot{\psi} (I_z - I_x) - K_{fax} \dot{\theta}^2 - J_r \bar{\Omega} \dot{\theta} + l U_3 \} \\ \ddot{\psi} = \frac{1}{I_z} \{ \dot{\phi} \dot{\theta} (I_x - I_y) - K_{fax} \dot{\psi}^2 + U_4 \} \\ \ddot{x} = \frac{1}{m} \{ (\cos \phi \sin \theta \cos \psi + \sin \phi \sin \psi) U_1 - K_{ftx} \dot{x} \} \\ \ddot{y} = \frac{1}{m} \{ (\cos \phi \sin \theta \sin \psi - \sin \phi \cos \psi) U_1 - K_{fty} \dot{y} \} \\ \ddot{z} = \frac{1}{m} \{ (\cos \phi \cos \theta) U_1 - K_{ftz} \dot{z} \} - g \end{array} \right. \quad (13)$$

where U_1, U_2, U_3 and U_4 are the control inputs of the system which are written according to the angular velocities of the four rotors as follows:

$$\begin{bmatrix} U_1 \\ U_2 \\ U_3 \\ U_4 \end{bmatrix} = \begin{bmatrix} b & b & b & b \\ 0 & -b & 0 & b \\ b & 0 & -b & 0 \\ d & -d & d & -d \end{bmatrix} \begin{bmatrix} \omega_1^2 \\ \omega_2^2 \\ \omega_3^2 \\ \omega_4^2 \end{bmatrix} \quad (14)$$

and

$$\bar{\Omega} = \omega_1 - \omega_2 + \omega_3 - \omega_4. \quad (15)$$

3. Rotor dynamics

The rotor is a unit constituted by DC-motor actuating a propeller via a reducer. The DC-motor is governed by the following dynamic equations:

$$\left\{ \begin{array}{l} V = ri + L \frac{di}{dt} + k_e \omega \\ k_m = J_r + C_s + k_r \omega^2. \end{array} \right. \quad (16)$$

Parameters of the motor are defined as follows:

- V – motor input.
- k_e, k_m – constant of the electrical and mechanical torque respectively.

- k_r – load torque constant.
- r – motor internal resistance.
- J_r – rotor inertia.
- C_s – solid friction.

Then the model chosen for the rotor is as follows

$$\dot{\omega}_i = bV_i - \beta_0 - \beta_1\omega_i - \beta_2\omega_i^2 \quad i \in [1, 4] \quad (17)$$

where

$$\beta_0 = \frac{C_s}{J_r}, \beta_1 = \frac{k_e k_m}{r J_r}, \beta_2 = \frac{k_r}{J_r} \quad \text{and} \quad b = \frac{k_m}{r J_r}$$

4. Control strategy

To achieve a robust path following by the quadrotor helicopter, two techniques, capable to control the helicopter in presence of sustained external disturbances, parametric uncertainties and unmodeled dynamics, are combined. The proposed control strategy is based on the decentralized structure of the quadrotor helicopter system, which is composed of the dynamic equation (1). The overall scheme of the control strategy is depicted in Fig. 2.

The translational motion control is performed in two stages. In the first one, the helicopter height, z , is controlled and the total thrust, U_1 , is the manipulated variable. In the second stage, the reference of pitch and roll angles (θ_r and ϕ_r , respectively) are generated through the two virtual inputs U_x and U_y , computed to follow the desired xy movement. Finally the rotation controller is used to stabilize the quadrotor under near quasi-stationary conditions with control inputs U_2 , U_3 and U_4 .

We divided this part in two steps. In the first one, we design the conventional sliding mode control, while the second proposes the fuzzy sliding mode control approach for the quadrotor helicopter control.

5. Fuzzy sliding mode control design

5.1. Sliding mode control design

Sliding mode control is a variable structure control (VSC). Basically, VSC includes several different continuous functions which map the plant state to the control surface. The switching among these functions is determined by the plant state which is represented by the switching function [20].

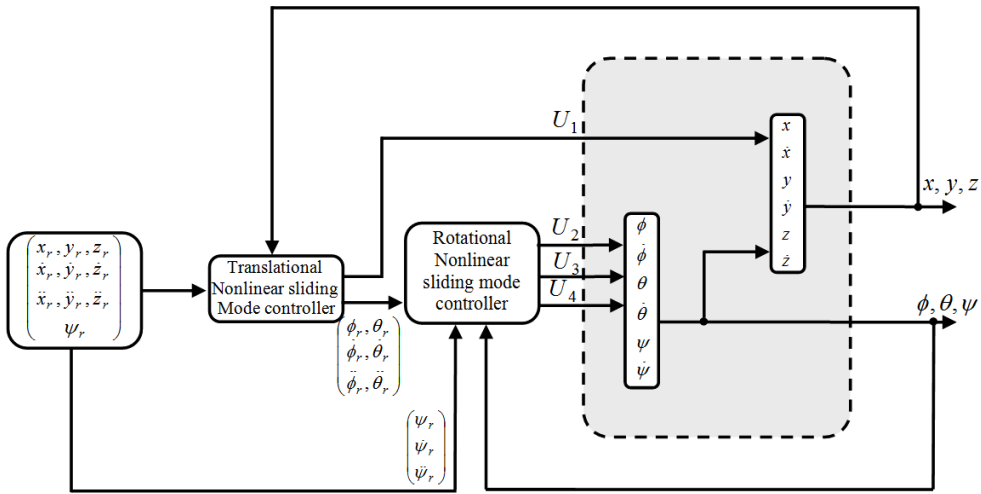

Figure 2. Quadrotor helicopter control structure.

Consider the system to be controlled described by state-space equation:

$$x^{(n)} = f(x,t) + g(x,t) u(t) \tag{18}$$

where $x(t) = (x, x^{(1)}, \dots, x^{(n-1)})^T$ is the vector of state variable $f(x,t)$ and $g(x,t)$ are nonlinear functions describing the system and $u(t)$ is the control signal. Design of the sliding mode control needs two steps. The choice of the sliding surface, and the design of the control law.

Step 1: the choice of the sliding surface.

Slotine proposes [21] the general form consisting of the respectively defined scalar function for sliding surface. The objective is the convergence of state variable x at its desired value. The general formulation of the sliding surface is given by the following equation [21]:

$$s(x) = \sum_{i=1}^{i=n} \lambda_i e_i = e_n + \sum_{i=1}^{n-1} \lambda_i e_i \tag{19}$$

where $\lambda_n = 1$, and $\lambda_i, (i = 1, \dots, n)$ represent the plan coefficients. Generally the sliding surface is given by the following linear function:

$$s(e) = e + \lambda \dot{e} \tag{20}$$

where λ is constant positive value, and $e = x - x_d$ with x_d being a desired value. When the function of commutation is calculated, the problem of tracking needs a concept of the

law control with the vector $e(t)$ rested on the sliding surface, then $s(e, t) = 0$ for $t \geq 0$. A suitable control $u(t)$ has to be found so as to retain the error on the sliding surface $s(e, t) = 0$. To achieve this purpose, a positive Lyapunov function V is defined as:

$$V(s, x, t) = \frac{1}{2} s^2(x, t) \tag{21}$$

Sufficient condition for the system stability is given by:

$$\dot{V}(s, x, t) = \dot{V}(s) = s \cdot \dot{s} < -\eta \cdot |s| \tag{22}$$

where η is the positive value $\eta > 0$.

Step 2: control law design.

The sliding mode control comports two terms namely equivalent control term and switching control term:

$$u = u_{eq} + u_s \tag{23}$$

where u_{eq} is the equivalent part of the sliding mode control, i.e. the necessary part of the control system when $\dot{s} = 0$; u_s described the discontinuous control and is given by:

$$u_s = -k \operatorname{sign}(s) - q s \quad \text{with } k, q > 0. \tag{24}$$

5.2. Fuzzy sliding mode controller design

The conventional sliding mode controller produces high frequency oscillations in its outputs, causing a problem known as chattering. The chattering is undesirable because it can excite the high frequency dynamics of the system. To eliminate chattering, a continuous fuzzy logic control u_f is used to approximate the discontinuous control. Design of the fuzzy controller begins with extending the crisp sliding surface $s = 0$ to the fuzzy sliding surface defined by linguistic expression [22]:

$$\tilde{s} \text{ is zero} \tag{25}$$

where \tilde{s} is the linguistic variable for s and ‘zero’ is one of its fuzzy sets. In order to partition the universe of discourse of s , the following fuzzy sets are introduced:

$$T(\tilde{s}) = \{NB, NM, ZE, PM, PB\} = \{F_s^1, \dots, F_s^5\} \tag{26}$$

where $T(\tilde{s})$ is the term set of \tilde{s} , and $NB, NM, ZE, PM,$ and PB are labels of fuzzy sets, which meaning are: negative big, negative medium, zero, positive medium, and positive big, respectively. For the control output u_f , its term set and labels of the fuzzy sets are defined similarly by

$$T(\tilde{u}_s) = \{NB, NM, ZE, PM, PB\} = \{F_u^1, \dots, F_u^5\} \tag{27}$$

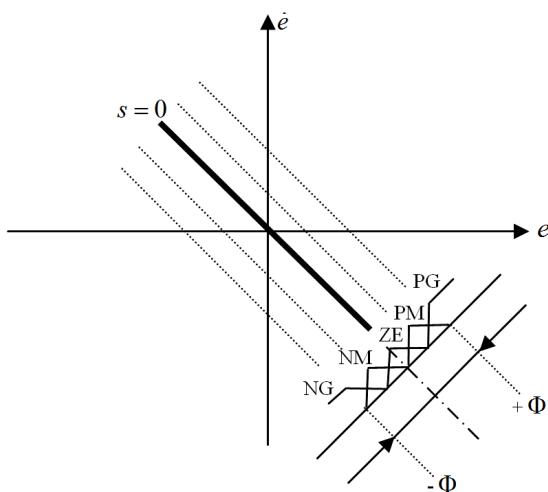

Figure 3. Fuzzy partition of the space around the sliding surface.

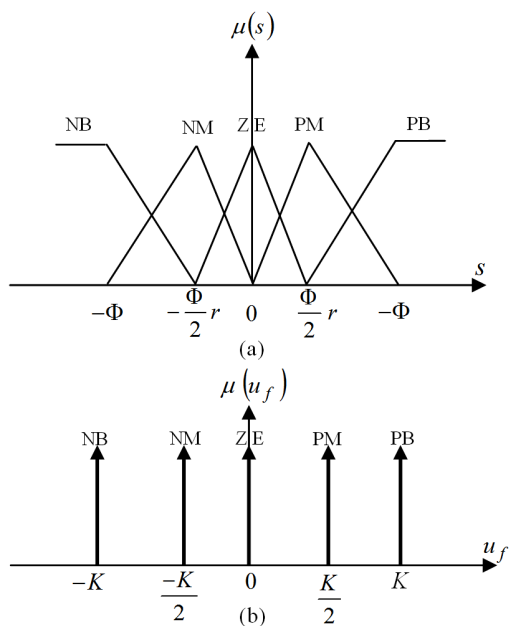

Figure 4. Membership function of input s and output u_f .

The membership functions of these fuzzy sets are depicted in Fig. 4. In Fig. 4.a, $r \in [0, 1]$ is the coefficient to be used to adjust the input centre point, and Φ defines boundary layer around the switch surface.

From these two term sets, we can build the following fuzzy rules [23]:

- R1 : IF s is NB then u_f is PB
- R2 : IF s is NM then u_f is PM
- R3 : IF s is ZE then u_f is ZE
- R4 : IF s is PM then u_f is NM
- R5 : IF s is PB then u_f is NB

Once the membership functions and fuzzy rules are determined, the final step is the defuzzification, which is the procedure to determine a crisp control for u_f . There are many defuzzification strategies such as the maximum criterion, the mean of maximum, the centre of area, and the weighted average method [22, 23]. We have used the weighted average method to get the crisp control for u_f . Then

$$u_f = \frac{\sum_{i=1}^5 C_{fi} \mu_i (s)}{\sum_{i=1}^5 \mu_i (s)} \tag{28}$$

where C_{fi} is the associated singleton membership function of u_f . Finally, the result of inference for every s can be written as follows:

$$u_f = -K \operatorname{sig} \left(\frac{s}{\Phi} \right) \tag{29}$$

where

$$\operatorname{sig}(z) = \begin{cases} -1 & z < -1 \\ \frac{z+r-1}{2-r} & -1 \leq z < -\frac{r}{2} \\ \frac{z}{r} & -\frac{r}{2} \leq z < \frac{r}{2} \\ \frac{z+1-r}{2-r} & \frac{r}{2} \leq z < 1 \\ 1 & 1 \leq z. \end{cases} \tag{30}$$

In Fig.5 we show the results of the influence of the fuzzy rules with different r . One can see in Fig. 5, that the value of r plays important role in shaping the fuzzy rules. If e.g. $r = 1$ then we obtain saturation function.

6. Backstepping sliding mode control of the quadrotor

The model (11) developed in the first part of this paper can be rewritten in the state-space form as follows:

$$\dot{X} = f(x) + g(X,U) + \delta \tag{31}$$

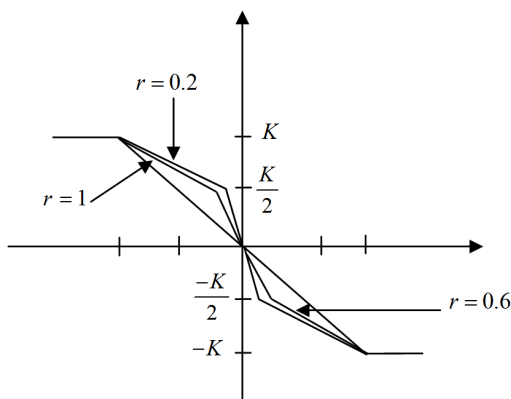

Figure 5. Results of the influence of the fuzzy rules.

where $X = [x_1, \dots, x_{12}]^T$ is the state vector of the system containing the entries

$$X = [\varphi, \dot{\varphi}, \theta, \dot{\theta}, \psi, \dot{\psi}, x, \dot{x}, y, \dot{y}, z, \dot{z}]^T.$$

From (11) and (29) we obtain the following state representation:

$$\left\{ \begin{array}{l} \dot{x}_1 = x_2 \\ \dot{x}_2 = a_1 x_4 x_6 + a_2 x_2^2 + a_3 \bar{\Omega} x_4 + b_1 U_2 \\ \dot{x}_3 = x_4 \\ \dot{x}_4 = a_4 x_2 x_6 + a_5 x_4^2 + a_6 \bar{\Omega} x_4 + b_2 U_3 \\ \dot{x}_5 = x_6 \\ \dot{x}_6 = a_7 x_2 x_4 + a_8 x_6^2 + b_3 U_4 \\ \dot{x}_7 = x_8 \\ \dot{x}_8 = a_9 x_8 + U_x \frac{U_1}{m} \\ \dot{x}_9 = x_{10} \\ \dot{x}_{10} = a_{10} x_{10} + U_y \frac{U_1}{m} \\ \dot{x}_{11} = x_{12} \\ \dot{x}_{12} = a_{11} x_{12} + \frac{\cos x_1 \cos x_3}{m} U_1 - g \end{array} \right. \quad (32)$$

$$\left\{ \begin{array}{l} a_1 = \left(\frac{I_y - I_z}{I_x} \right), \quad a_2 = \frac{-K_{fax}}{I_x}, \quad a_3 = \frac{-J_r}{I_x} \\ a_4 = \left(\frac{I_z - I_x}{I_y} \right), \quad a_5 = \frac{-K_{fay}}{I_y}, \quad a_6 = \frac{J_r}{I_y} \\ a_7 = \left(\frac{I_x - I_y}{I_z} \right), \quad a_8 = \frac{-K_{faz}}{I_z}, \quad a_9 = \frac{-K_{ftx}}{m} \\ a_{10} = \frac{-K_{fty}}{m}, \quad a_{11} = \frac{-K_{fyz}}{m}, \quad b_1 = \frac{l}{I_x}, \quad b_2 = \frac{l}{I_y}, \quad b_3 = \frac{l}{I_z}, \end{array} \right. \quad (33)$$

$$\left\{ \begin{array}{l} U_x = \cos x_1 \sin x_3 \cos x_5 + \sin x_1 \sin x_5 \\ U_y = \cos x_1 \sin x_3 \sin x_5 - \sin x_1 \cos x_5. \end{array} \right. \quad (34)$$

In this section we develop a sliding mode controller for the quadrotor based on backstepping approach using the technique presented in [27]. Using the backstepping approach as a recursive algorithm for the control-law synthesis, one can gather succeeding stages of calculation concerning the tracking errors and Lyapunov function in the following way:

$$z_i = \begin{cases} x_{id} - x_i & i \in \{1, 3, 5, 7, 9, 11\} \\ x_i - \dot{x}_{i-1} - \alpha_{i-1} z_{i-1} & i \in \{2, 4, 6, 8, 10, 12\} \end{cases} \quad (35)$$

where $\alpha_i > 0 \quad \forall i \in [1, 12]$,

$$V_i = \begin{cases} \frac{1}{2} z_i^2 & i \in \{1, 3, 5, 7, 9, 11\} \\ \frac{1}{2} (V_{i+1} + z_i^2) & i \in \{2, 4, 6, 8, 10, 12\}. \end{cases} \quad (36)$$

The sliding surface is computed by the following function:

$$\left\{ \begin{array}{l} s_\varphi = z_2 = x_2 - \dot{x}_{1d} - \alpha_1 z_1 \\ s_\theta = z_4 = x_4 - \dot{x}_{3d} - \alpha_3 z_3 \\ s_\psi = z_6 = x_6 - \dot{x}_{5d} - \alpha_5 z_5 \\ s_x = z_8 = x_8 - \dot{x}_{7d} - \alpha_7 z_7 \\ s_y = z_{10} = x_{10} - \dot{x}_{9d} - \alpha_9 z_9 \\ s_z = z_{12} = x_{12} - \dot{x}_{11d} - \alpha_{11} z_{11} \end{array} \right. \quad (37)$$

so that $s_\varphi, s_\theta, s_\psi, s_x, s_y$ and s_z are the dynamic sliding surfaces. To synthesize stabilizing control law by sliding mode, the necessary sliding condition $\dot{s}s < 0$ must be held so the

synthesized stabilizing control laws are as follows:

$$\left\{ \begin{array}{l} U_2 = \frac{1}{b_1} \{ -k_1 \text{sign}(s_\varphi) - q_1 s_\varphi - a_1 x_4 x_6 - a_2 x_2^2 - a_3 x_4 \bar{\Omega} + \ddot{\varphi}_d + \alpha_1 (\dot{\varphi}_d - x_2) \} \\ U_3 = \frac{1}{b_2} \{ -k_2 \text{sign}(s_\theta) - q_2 s_\theta - a_4 x_2 x_6 - a_5 x_4^2 - a_6 x_2 \bar{\Omega} + \ddot{\theta}_d + \alpha_2 (\dot{\theta}_d - x_4) \} \\ U_4 = \frac{1}{b_3} \{ -k_3 \text{sign}(s_\psi) - q_3 s_\psi - a_7 x_2 x_4 - a_8 x_6^2 + \ddot{\psi}_d + \alpha_3 (\dot{\psi}_d - x_6) \} \\ U_x = \frac{m}{U_1} \{ -k_4 \text{sign}(s_x) - q_4 s_x - a_9 x_8 + \ddot{x}_d + \alpha_4 (\dot{x}_d - x_8) \} \text{ for } U_1 \neq 0 \\ U_y = \frac{m}{U_1} \{ -k_5 \text{sign}(s_y) - q_5 s_y - a_{10} x_{10} + \ddot{y}_d + \alpha_5 (\dot{y}_d - x_{10}) \} \text{ for } U_1 \neq 0 \\ U_1 = \frac{m}{\cos x_1 \cos x_3} \{ -k_6 \text{sign}(s_z) - k_6 s_z - a_{11} x_{12} + \ddot{z}_d + g + \alpha_6 (\dot{z}_d - x_{12}) \} \end{array} \right. \quad (38)$$

where $(k_i, q_i) \in \mathfrak{R}^{+2}$.

To derive the control laws (38) we can take from (33) and (34) the following:

$$\left\{ \begin{array}{l} V_1 = \frac{1}{2} z_1^2 \\ z_1 = x_{1d} - x_1, \end{array} \right. \quad \left\{ \begin{array}{l} V_2 = \frac{1}{2} z_1^2 + \frac{1}{2} z_2^2 \\ z_2 = x_2 - \dot{x}_{1d} - \alpha_1 z_1, \end{array} \right. \quad (39)$$

We can compute the sliding surface in the following way:

$$s_\varphi = z_2 = x_2 - \dot{x}_{1d} - \alpha_1 z_1 \quad (40)$$

$$V_2 = \frac{1}{2} z_1^2 + \frac{1}{2} s_\varphi^2 \quad (41)$$

and

$$\dot{V}_2 = z_1 \dot{z}_1 + s_\varphi \dot{s}_\varphi \quad (42)$$

$$\dot{V}_2 = z_1 \dot{z}_1 + s_\varphi \{ a_2 x_2^2 + a_1 x_4 x_6 + a_3 x_4 \bar{\Omega} + b_1 U_2 - \ddot{\varphi}_d - \alpha_1 (\dot{\varphi}_d - x_2) \}. \quad (43)$$

The chosen law for the attractive surface is the time derivative of (37) stratifying the necessary condition of sliding ($s_\varphi \dot{s}_\varphi < 0$):

$$\begin{aligned} \dot{s}_\varphi &= -k_1 \text{sign}(s_\varphi) - q_1 s_\varphi = \dot{x}_2 - \ddot{x}_{1d} - \alpha_1 \dot{z}_1 \\ &= a_1 x_4 x_6 + a_2 x_2^2 + a_3 \bar{\Omega} x_4 + b_1 U_2 - \ddot{\varphi}_d - \alpha_1 (\dot{\varphi}_d - x_2). \end{aligned} \quad (44)$$

For the backstepping approach, the control input U_2 is extracted:

$$U_2 = \frac{1}{b_1} \{ -k_1 \text{sign}(s_\varphi) - q_1 s_\varphi - a_1 x_4 x_6 - a_2 x_2^2 - a_3 x_4 \bar{\Omega} + \ddot{\varphi}_d + \alpha_1 (\dot{\varphi}_d - x_2) \} \quad (45)$$

$$\begin{cases} \Delta U_2 = \frac{1}{b_1} \{-k_1 \text{sign}(s_\varphi) - q_1 s_\varphi\} \\ U_{2eq} = \frac{1}{b_1} \{-a_1 x_4 x_6 - a_2 x_2^2 - a_3 x_4 \bar{\Omega} + \ddot{\varphi}_r + \alpha_1 (\dot{\varphi}_d - x_2)\}. \end{cases} \quad (46)$$

The same steps are to be performed to extract U_3, U_4, U_x, U_y and U_1 .

The desired roll and pitch angles in terms of errors between actual and desired speeds are, thus, separately given by:

$$\varphi_r = \arcsin(U_x \sin \psi - U_y \cos \psi) \quad (47)$$

$$\theta_r = \arcsin\left(\frac{U_x}{\cos \varphi \cos \psi} - \frac{\sin \varphi \sin \psi}{\cos \varphi \cos \psi}\right). \quad (48)$$

7. The proposed fuzzy sliding mode control of the quadrotor

In this section, the objective is to apply the hybrid fuzzy sliding mode control in order to solve the problem of chattering phenomenon. The control system applied to the quadrotor is given by:

$$u = u_{eq} + u_f \quad (49)$$

Discontinuous control u_f is calculated by a fuzzy inference system and its description is already given in section 5.2.

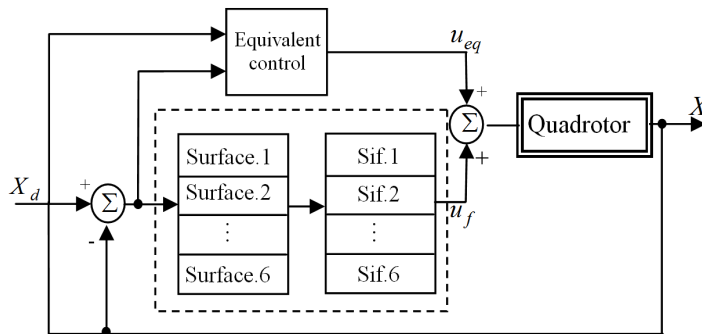

Figure 6. Block diagram of the backstepping fuzzy-sliding mode control system applied to the quadrotor.

8. Simulation results

In this section, simulations results are presented to illustrate the performance and robustness of proposed control law when applied to the full quadrotor helicopter model with the stabilization and trajectory tracking.

8.1. Step responses of the quadrotor

The results of using backstepping sliding mode controller are shown in Fig. 7–11. The results obtained using the proposed control strategy (backstepping fuzzy sliding mode) are shown in Fig. 12–16. From the simulation results, we can conclude that the control result of the backstepping sliding mode controller produces a serious chattering phenomenon, and on the contrary, the chattering phenomenon of the controlled system was suppressed in the proposed control strategy, as shown in U_1, U_2, U_3 and U_4 evolution (compare Fig. 9.a, Fig. 9.b, Fig. 9.c, Fig. 9.d and Fig. 14.a, Fig. 14.b, Fig. 14.c, Fig. 14.d).

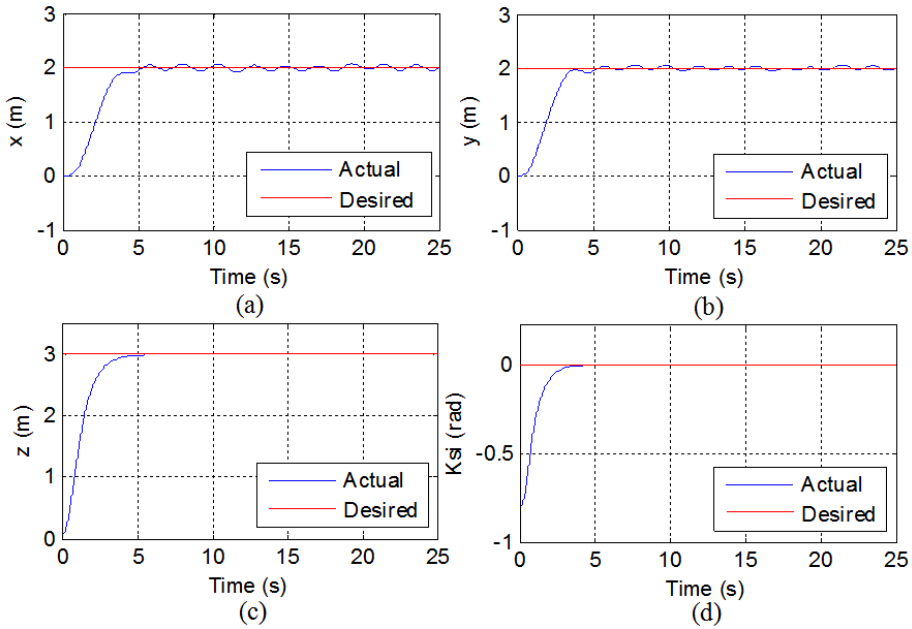

Figure 7. Steps responses results of the desired trajectories along (x,y,z) axis and yaw angle ψ using backstepping sliding mode.

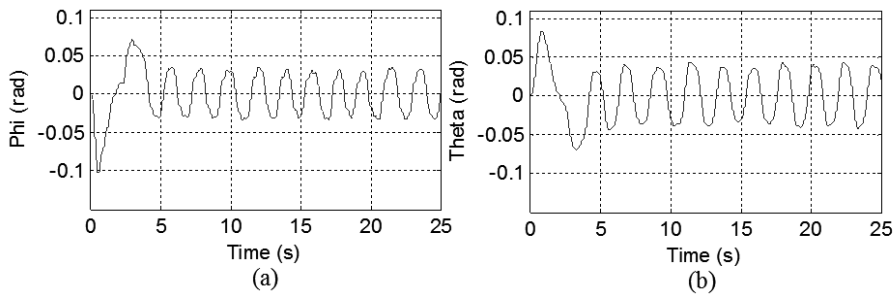

Figure 8. Simulation results of the roll angle ϕ and pitch angle θ using backstepping sliding mode.

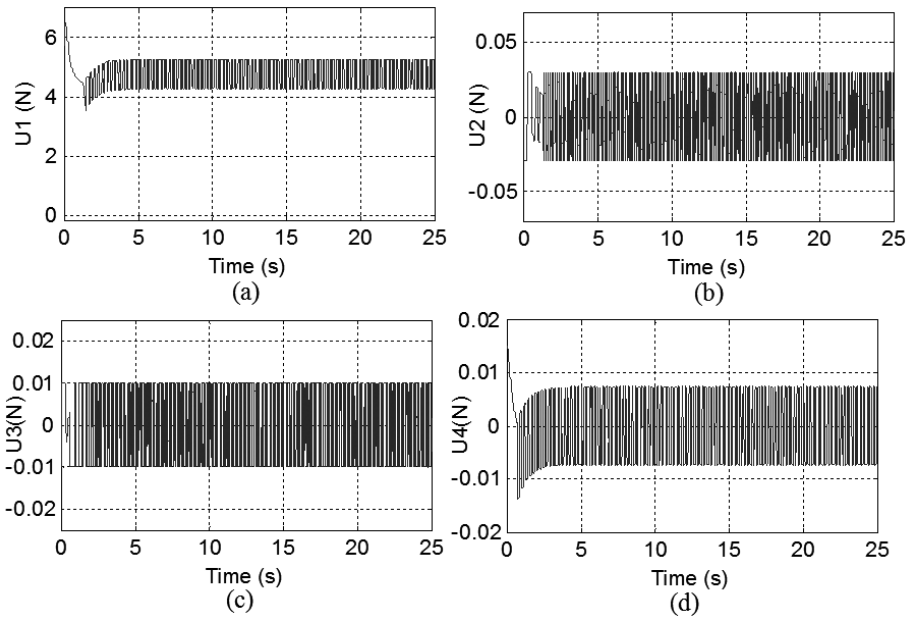

Figure 9. Control response of a quadrotor helicopter using backstepping sliding mode.

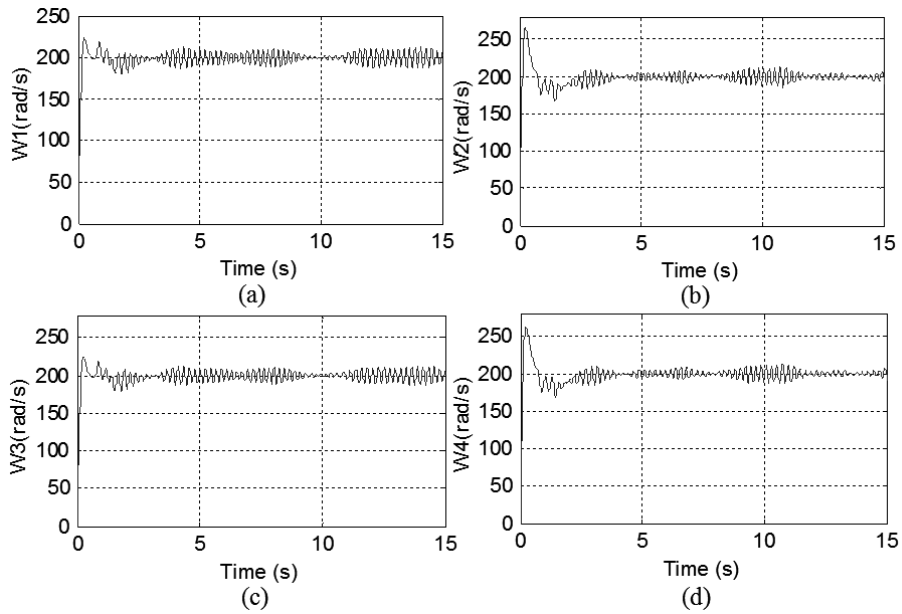

Figure 10. Angular velocities of the four rotors using backstepping sliding mode.

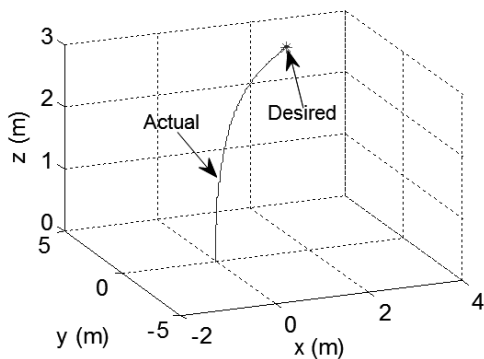

Figure 11. Global trajectory of the quadrotor in 3D using backstepping sliding mode.

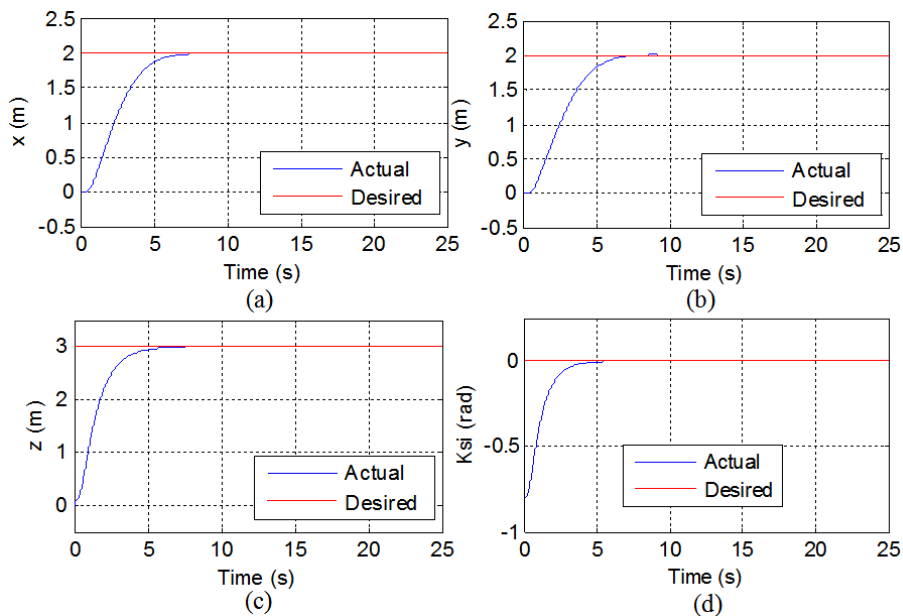

Figure 12. Steps responses results of the desired trajectories along (x, y, z) axis and yaw angle ψ using backstepping fuzzy sliding mode.

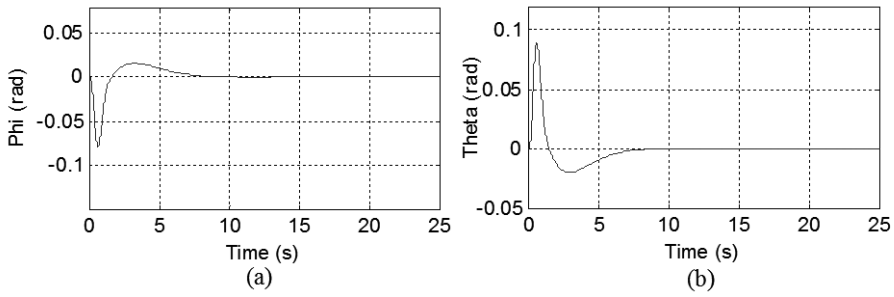

Figure 13. Simulation results of the roll angle ϕ and pitch angle θ using backstepping fuzzy sliding mode.

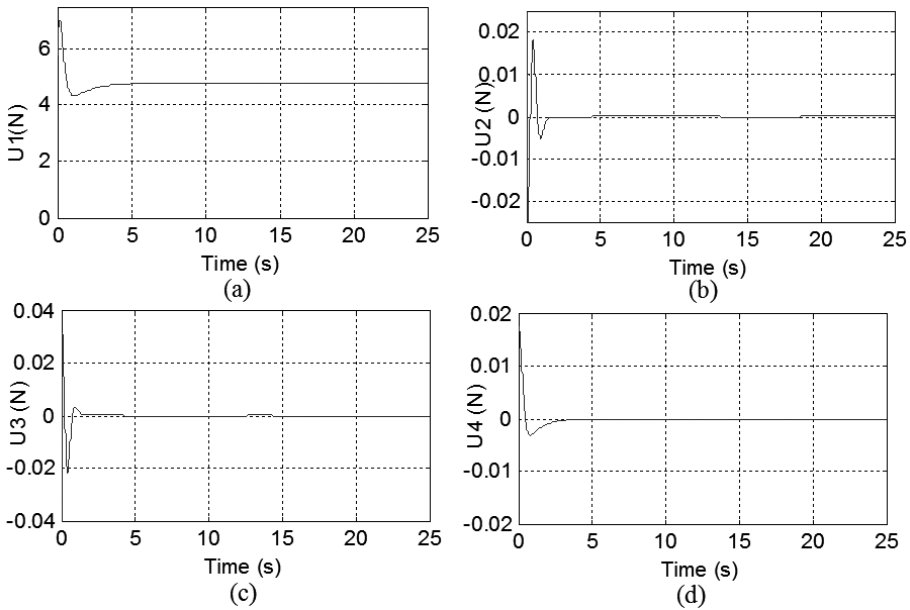

Figure 14. Control response of a quadrotor helicopter using backstepping fuzzy sliding mode.

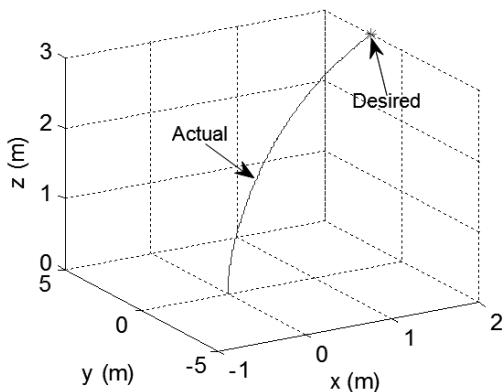

Figure 15. Global trajectory of the quadrotor in 3D using fuzzy backstepping sliding mode.

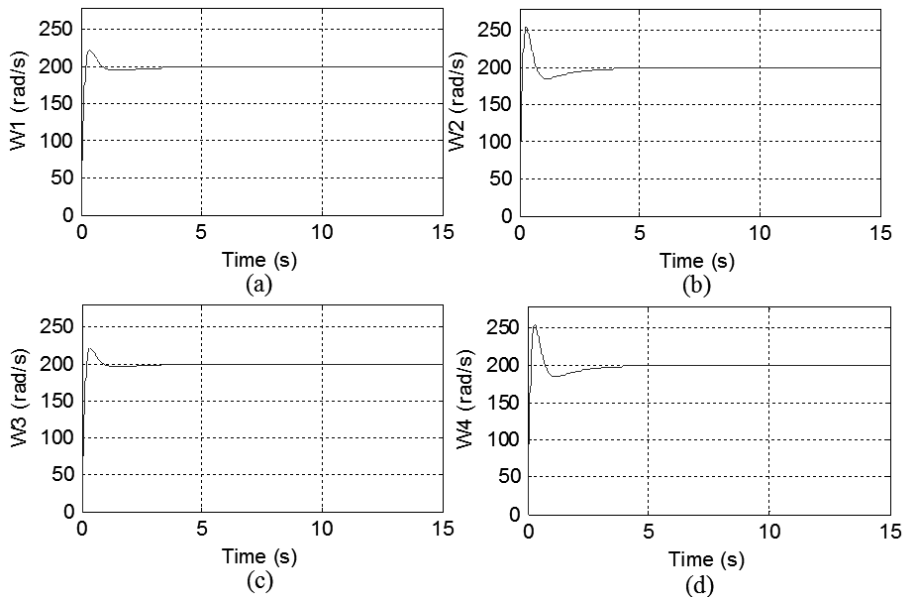

Figure 16. Angular velocities of the four rotors using fuzzy sliding mode.

8.2. Tracking response of the quadrotor

The simulation results for the backstepping sliding mode control are presented in Fig. 17–21. Performance of the backstepping fuzzy sliding mode method are shown in Fig.22–26. Note the improvement of results of the backstepping fuzzy sliding mode method. In fact, the elimination of the chattering problem permits the smoothness of the

control law (compare Fig. 19.a, Fig. 19.b, Fig. 19.c, Fig. 19.d and Fig.24.a, Fig. 24.b, Fig. 24.c and Fig. 24.d).

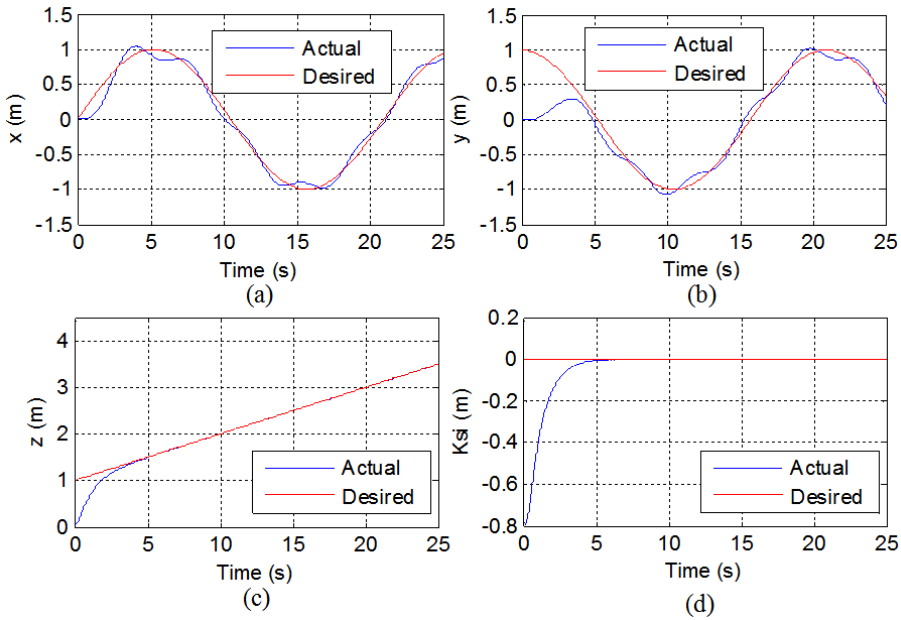

Figure 17. Tracking responses results of the desired trajectories along (x,y,z) axis and yaw angle ψ using backstepping sliding mode.

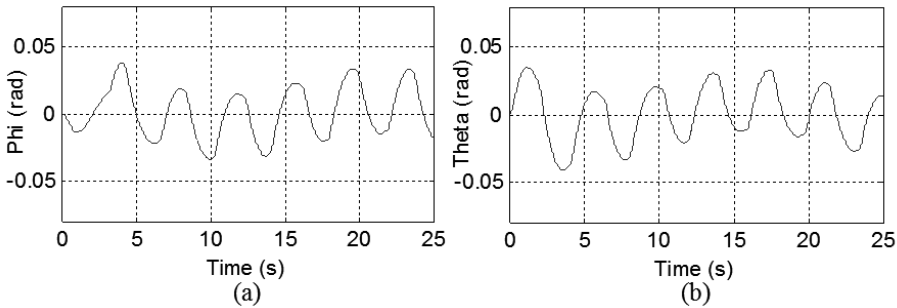

Figure 18. Simulation results of the roll angle ϕ and pitch angle θ using backstepping sliding mode.

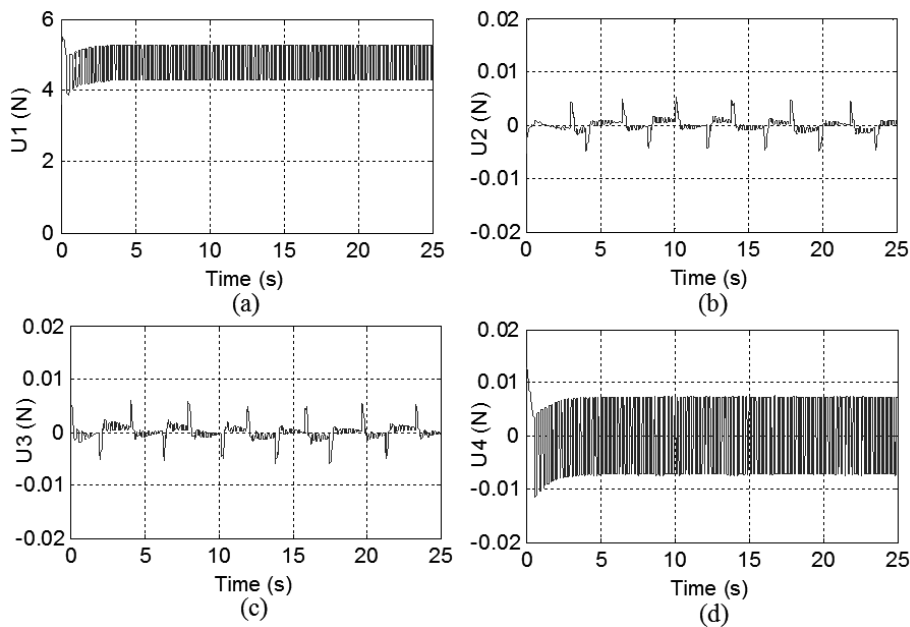

Figure 19. Control response of a quadrotor helicopter using backstepping sliding mode.

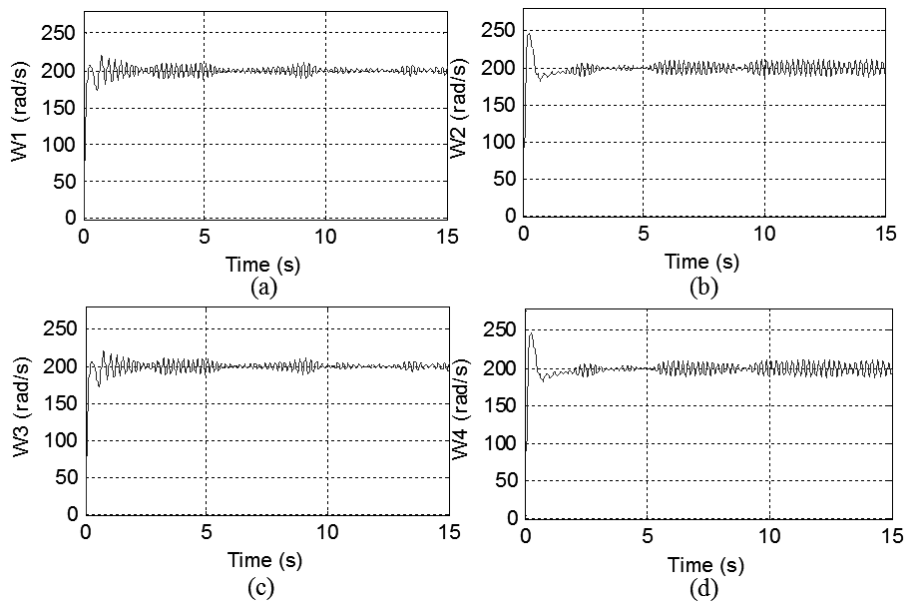

Figure 20. Angular velocities of the four rotors using backstepping sliding mode.

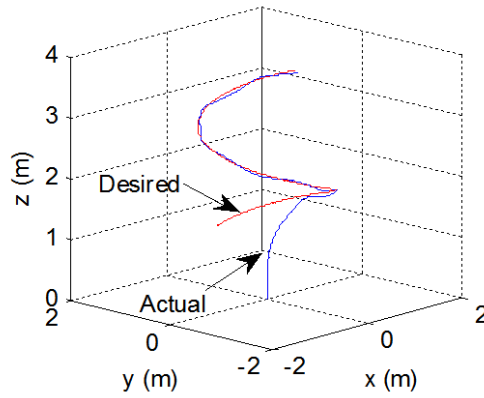

Figure 21. Global trajectory of the quadrotor in 3D using backstepping sliding mode.

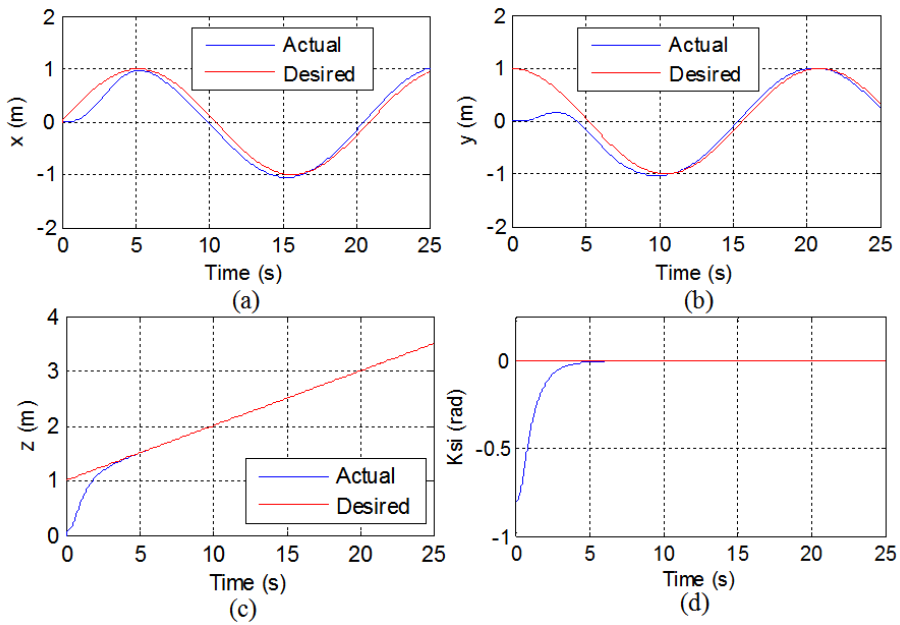

Figure 22. Tracking responses results of the desired trajectories along (x,y,z) axis and yaw angle ψ using backstepping fuzzy sliding mode.

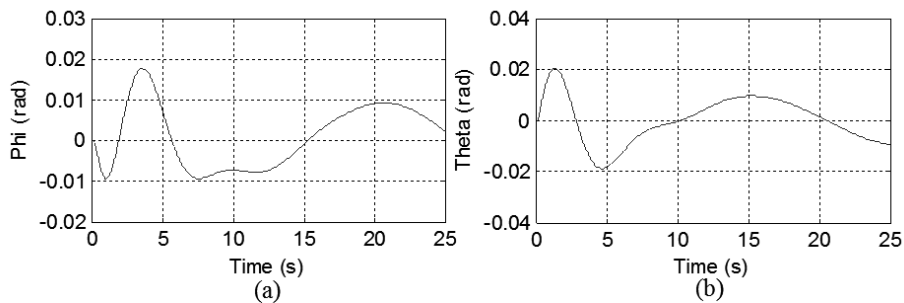

Figure 23. Simulation results of the roll angle ϕ and pitch angle θ using backstepping fuzzy sliding mode.

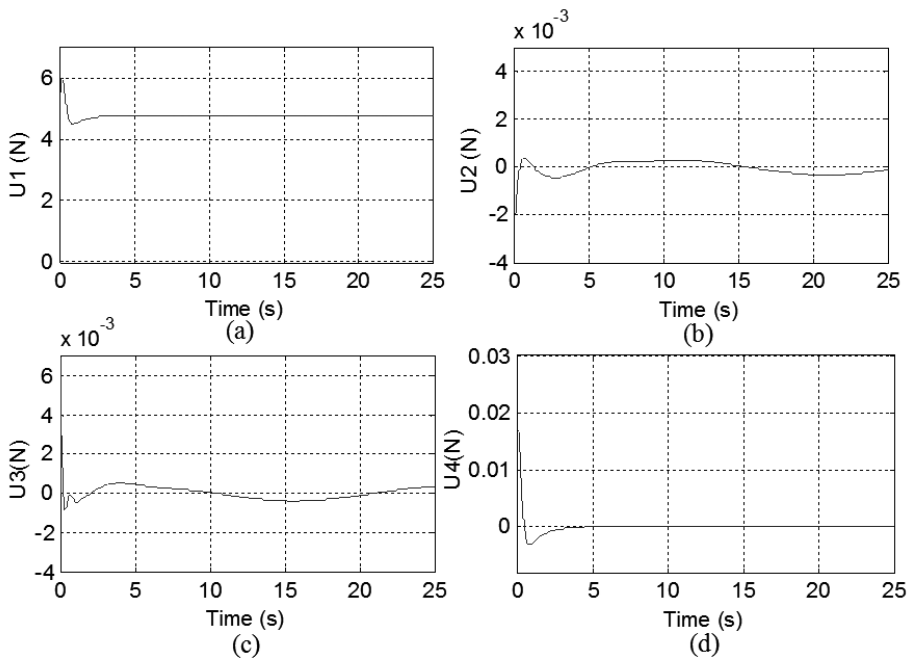

Figure 24. Control response of a quadrotor helicopter using backstepping fuzzy sliding mode.

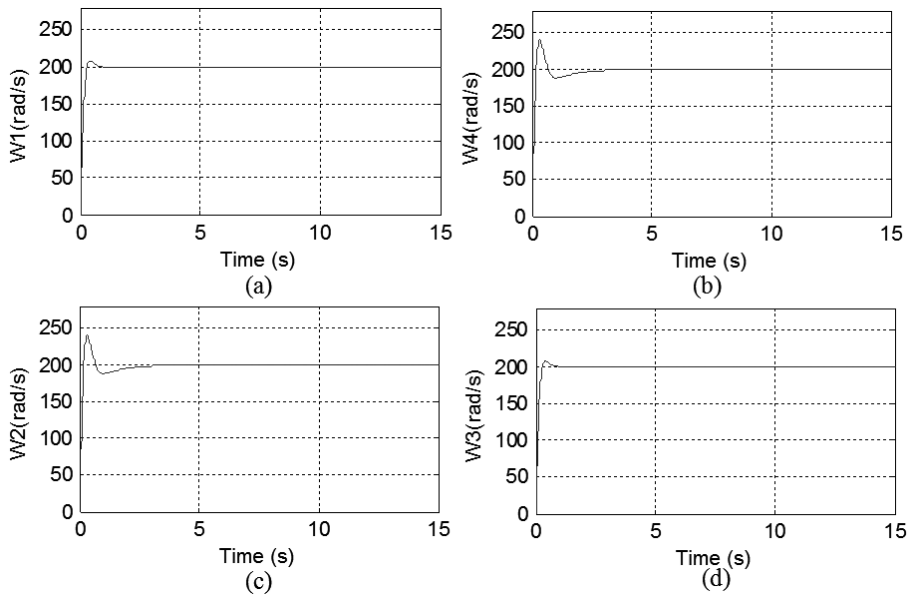

Figure 25. Angular velocities of the four rotors using fuzzy backstepping sliding mode.

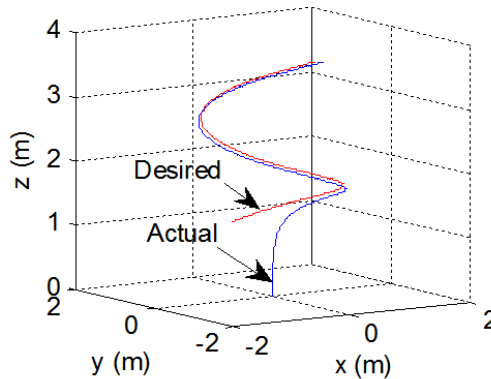

Figure 26. Global trajectory of the quadrotor in 3D using fuzzy backstepping sliding mode.

9. Conclusion

Stabilization nonlinear control method for a quadrotor helicopter is presented in this paper. The modeling of the quadrotor is based on Newton-Euler formalism. A novel control strategy is applied to position and rotational subsystem of the quadrotor helicopter, where the tracking error is considered in the first step of the backstepping procedure. The control law, derived for the nonlinear quadrotor, is thus a sliding mode based, back-

stepping method for regulation dynamics. However, this method contains the chattering phenomenon in the evolution of the control laws, thus a solution based on the backstepping fuzzy sliding mode control method is proposed. This method is a combination of fuzzy logic control with the backstepping sliding mode control. The combination forces the real position towards the values required to achieve the control objective. Through the simulation results, it can be seen that fuzzy logic control can be applied to reduce the chattering phenomenon of the backstepping sliding mode control.

References

- [1] D.LEE, H. JIN KIM and S.SASTRY: Feedback linearization vs. adaptive sliding mode control for a quadrotor helicopter. *Int. J. of Control, Automation, and Systems*, 7(3), (2009), 419-428.
- [2] A.TAYEBI and S. MCGILVRAY: Attitude stabilisation of a VTOL quadrotor aircraft. *IEEE Trans. on Control Systems Technology*, 14(3), (2006).
- [3] L. DERAFA and T. MADANI and A. BENALLEGUE: Dynamic modelling and experimental identification of four rotor helicopter parameters. *IEEE Conf. on Industrial Technology*, Mumbai, India (2006).
- [4] S. BOUABDALLAH, A. NOTH and R. SIEGWART: PID vs LQ control techniques applied to an indoor micro quadrotor. Autonomous Systems Laboratory, Swiss Federal Institute of Technology Lausanne, Switzerland, 2004.
- [5] M. BOUCHOUCHA, M. TADJINE, A. TAYEBI and P. M ULLHAUPT: Step by step robust nonlinear PI for attitude stabilisation of a four-rotor mini-aircraft. *16th Mediterranean Conf. on Control and Automation*, Ajaccio, France, (2008).
- [6] Y. AI-YOUNES and M. JARRAH: Attitude stabilization of quadrotor UAV using backstepping fuzzy logic backstepping least-mean-square controllers. *Proc. of the 5th Int. Symp. on Mechatronics and its Applications*, Amman, Jordan, (2008).
- [7] T. MADANI and A. BENALLEGUE: Control of a quadrotor mini-helicopter via full state backstepping technique. *Proc. of the 45th IEEE Conf. on Decision & Control*, San Diego, CA, USA, (2006).
- [8] S. BOUABDALLAH and R. SIEGWART: Backstepping and sliding-mode techniques applied to an indoor micro quadrotor. *Proc. of the 2005 IEEE Int. Conf. on Robotics and Automation*, Barcelona, Spain, (2005).
- [9] E. ALTUG, J.P. OSTROWSKI and R. MAHONY: Control of a quadrotor helicopter using visual feedback. *Prec of the 2002 IEEE Int. Conf. on Robotics and Automation*, Washington, USA, (2002).

- [10] A. DAS, F. LEWIS and K.SUBBARAO: Backstepping approach for controlling a quadrotor using Lagrange form dynamics. *J. of Intelligent and Robototic Systems*, **56** (2009), 127-151.
- [11] A. MOKHTARI, A. BENALLEGUE and B. DAACHI: Robust feedback linearization and GH_∞ controller for a quadrotor unmanned aerial vehicle. *J. of Electrical Engineering*, **57**(1), (2006), 20-27.
- [12] A. AHMAD MIAN and W. DAOBO: Modeling and backstepping-based nonlinear control strategy for a 6 DOF quadrotor helicopter. *Chinese J. of Aeronautics*, **21** (2008), 261-268.
- [13] C. COZA and C.J.B. MACNAB: A new robust adaptive-fuzzy control method applied to quadrotor helicopter stabilization. *Fuzzy Information Processing Society, Annual meeting of the North American*. (2006), 454-458.
- [14] K.M. ZEMALACHE and H. MAAREF: Controlling a drone: Comparison between a based model method and a fuzzy inference system. *Applied Soft Computing*, **9** (2009), 553-562.
- [15] G.V. RAFFO, M.G. ORTEGA and F.R. RUBIO: An integral predictive/nonlinear H_∞ control structure for a quadrotor helicopter. **46**(1), *Automatica*, (2010), 29-39.
- [16] V.I. UTKIN: *Sliding Modes in Control and Optimization*. Springer-Verlag, 1992.
- [17] RONG XU and UMIT OZG UNER: Sliding mode control of a class of underactuated systems. *Automatica*, **44** (2008), 233-241.
- [18] Z. FANG, Z. ZHI, L. JUN and W. JIAN: Feedback linearization and continuous sliding mode control for a quadrotor UAV. *Proc. of the 27th Chinese Control Conf.*, Kunming, Yunnan, China, (2008).
- [19] T. MADANI and A. BENALLEGUE: Backstepping sliding mode control applied to a miniature quadrotor flying robot. *IEEE Conf. on Industrial Electronics*, Paris, France, (2006).
- [20] F. XIANG: Block-oriented nonlinear control of pneumatic actuator systems. Doctoral thesis. Department of Machine Design, Royal Institute of Technology, Sweden, 2001.
- [21] B. MOSHIRI, M. JALILI-KHARAAJOO and F. BESHARATI: Application of fuzzy sliding mode based on genetic algorithms to control of robotic manipulators. *Proc. IEEE, of Int. Conf. on Emerging Technologies and Factory Automation*, (2003), 169-172.
- [22] J.Z. LIU, W.J. ZHAO and L.J. ZHANG: Design of sliding mode controller based on fuzzy logic. *Proc. of the 3rd IEEE Conf. on Machine Learning and Cybernetics*, IEEE Press, Shanghai, China, (2004), 616-619.

- [23] S.W. KIM and J.J. LEE: Design of a fuzzy controller with fuzzy sliding surface. *Fuzzy Sets and Systems*, **71**(3), (1995), 359-367.