

## Ceramic on Ceramic Bearings



Khumrak S, MD<sup>1</sup>  
email : skbiggumz@gmail.com

Sukree Khumrak, MD<sup>1</sup>  
Thanasak Yakampor, MD<sup>2</sup>

<sup>1</sup> Orthopedics Department, Bangkok Hospital Pattaya,  
Bangkok Hospital Group, Pattaya, Thailand.

<sup>2</sup> Burapha University, Chonburi, Thailand

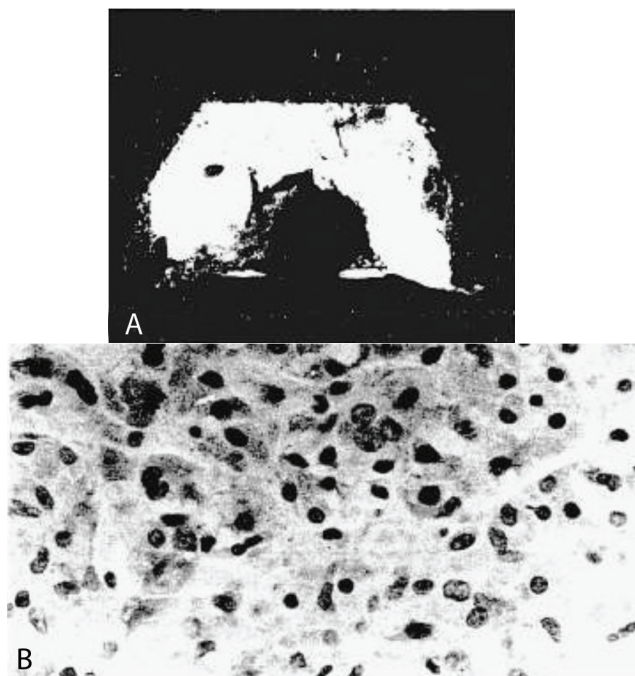
### Keywords:

total hip replacement, ceramic on ceramic bearings,  
alumina matrix composite, squeaking sound, stripe  
wear, ceramic fracture

**M**etal on Polyethylene bearings have been widely used in total hip replacements for over 40 years. However there are still concerns about implant failures due to aseptic loosening and osteolysis, which occurs as a result of immune system responses triggered by the microscopic debris generated by normal wear and tear of the prosthetic joint.

Willert<sup>1</sup> suggest that Ultra-high monolecular weight polyethylene (UHMWPE) can be responsible for the formation of osteolysis occurring in areas around endoprosthetic implants, especially if greater amounts of this polymer's particles are released into the tissue.

In 1992, Amstutz et al.<sup>2</sup> discussed the factors leading to massive osteolysis, namely polyethylene wear debris induced osteolysis. Macrophages activated by phagocytosis of particulate wear debris are the key cells in this process. (Figure 1)



**Figure 1 A-B:** (A) Retrieved titanium-alloy femoral porous-coated surface replacement bisected to show the replacement of bone by an invasive granulamalike tissue. This component failed after 50 months in an active 62-year-old man. (B) Histology of the tissue within the femoral head shows sheets of macrophages and giant cells, many with fine, intracellular metallic or UHMWPE debris. Lymphocytes are rarely seen in these tissues. (Stain, toluidine blue; original magnification, X60.)

Therefore, due to the most common cause of implant failure in Total Hip Replacement still being aseptic loosening from polyethylene wear debris, new bearing surfaces have been developed, such as ceramic on ceramic, in an attempt to reduce wear debris

### Ceramic on Ceramic Bearings

Hard on Hard bearings (Ceramic on ceramic (COC) and Metal on metal) were developed because the long term outcome of Metal on non cross linked polyethylene was unsatisfactory due to the aforementioned extensive osteolysis from macrophage induced osteolysis.<sup>2</sup> Historically, the use of ceramic bearing was first introduced in April 1970 with Alumina-on-alumina bearings by Dr. Pierre Boutin<sup>3</sup> (Figure 2).

The advantage of ceramic on ceramic (COC) was shown by in vitro analysis to reduce wear debris particles that cause osteolysis<sup>4,5</sup> and Ceramic bearings made from Alumina have showed the lowest in vivo wear rates of any bearing couples.<sup>6</sup> The important property of ceramic that caused a lower wear rate was its being hydrophilic (Figure 3) Ceramic's hydrophilic properties facilitate an increased wettability of the surface because of the strong hydrogen bonds between the ceramic surface and synovial fluid that results in the synovial film being more uniformly distributed. In addition, ceramic has a greater hardness than metal and can be polished to a lower surface roughness (Figure 4). Lastly, ceramics have a high degree of Biocompatibility. Catelas et al.<sup>7</sup> reported in vitro studies show less macrophage reaction and decreased cytokine secretion when exposed to ceramic particles versus high-density polyethylene because of their small size, low volume, and inertness. These overall properties of ceramic create the lowest coefficient of friction and this bearings combination is the most likely to achieve true fluid film lubrication.<sup>8</sup>

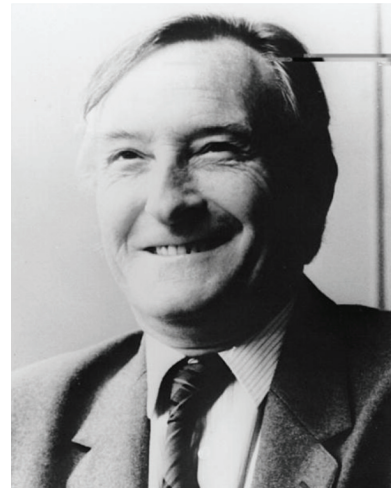


Figure 2: Dr. Pierre Boutin (photograph courtesy of Laurent Sedel, MD)

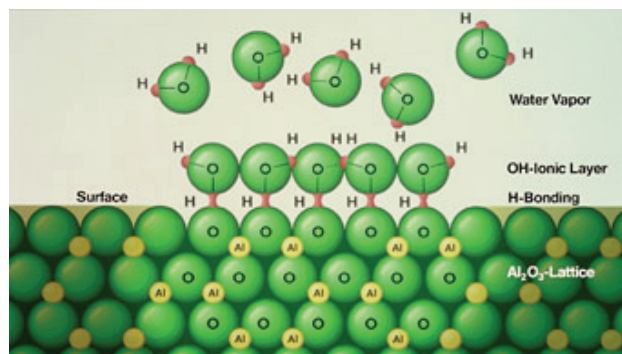


Figure 3: The strong hydrogen bond that forms between ceramic surfaces and synovial fluid give ceramic materials wetting properties that are superior to those of metal and polyethylene.

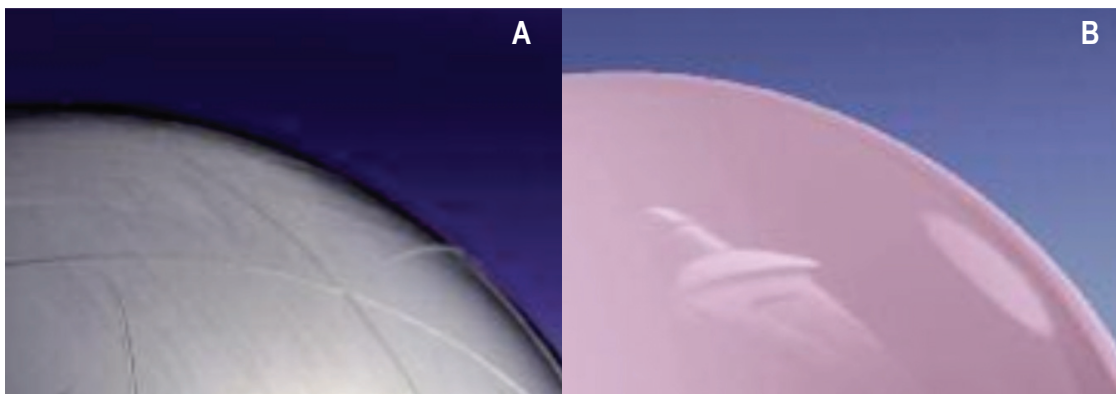


Figure 4 A-B: Shows no scratches on fourth Generation ceramics surface due to high degree of Hardness. (A) Scratched surface increases abrasion on surface of cup liners made of Polyethylene And Metal (CeramTec). (B) Only an unscratched smooth surface of the sort achieved in Fourth Generation ceramics enables optimal wetting, outstanding lubrication and minimal wear (CeramTec)

However, the results of the early generation of COC were not promising due to poor design, inadequate material properties, and imperfect craftsmanship leading to catastrophic failures with ceramic fractures and excessive wear rate.

The first generations of COC were introduced between 1974 and 1988; at that time long sintering times resulted in large grained size material, which lead to decreased strength and crack propagation and thus a high incidence of ceramic fracture. The second generation of COC was developed between 1988 to 1994. Mixing micro-arc oxidation (CAO) and magnesium oxide (MgO) as sintering aids into the Alumina also limited the grain size, thus decreasing incidence of ceramic fracture. The Third Generation of COC was developed between 1994 to 2004. Improvements in manufacturing such as isostatic pressing, laser etching and proof testing resulted in a purer, denser ceramic with a small grain size, which reduced crack propagation and fracture.<sup>9</sup>

The mechanical properties of the three generations of ceramics are summarized in Table 1.<sup>8</sup>

The newest or fourth generation ceramic on ceramic design is Alumina-Matrix-Composite (AMC) or Biolox-Delta (Figure 5) which is composed of Alumina Oxide (approximately 75%), Zirconium Oxide, Chromium Oxide and other oxides. The combination of mechanical properties

(fracture strength of Zirconia ceramic is approximately double that of alumina) and the good tribological properties of alumina ceramic make this an improved material for hip implants.

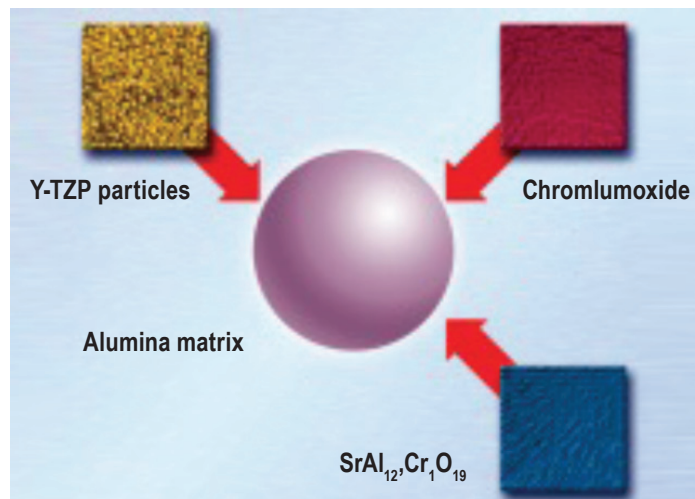
**Surgical Grade Ceramics in Orthopaedics**

*Alumina Ceramics*

Ceramics can be defined as inorganic non metallic materials compounded of a non metal and a metal. Alumina is a monophasic polycrystalline, very hard, stable and highly oxidized, with a high thermal conductivity coefficient, low bending stress and low resilience. The resultant material is in its highest state of oxidation, allowing thermodynamic stability, chemical inertness, and therefore excellent resistance to corrosion. The ionic structure of alumina ceramic creates a hydrophilic structure and fluid-film lubrication resulting in a higher wettability. In vitro studies show water is absorbed with high bond strength and that proteins quickly and completely cover the ceramic surface with a monolayer after surgical implantation; this phenomenon therefore improves lubrication of the joint. But Alumina ceramics are brittle because of excellent compression strength and bending strength is limited. Alumina ceramics can also break without warning signs due to low fracture toughness: ceramic has no possibility to deform without breakage.<sup>11</sup>

**Table 1:** The Changes in Grain Size and Burst Strength for Each Generation of Ceramic Manufacturing

Material Property	Generation I	Generation II	Generation III
Grain Size (µm)	4.2	3.2	1.8
Burst Strength (kN)	46	58	65



**Figure 5:** Composition of the alumina matrix composite (CeramTec)

*Zirconia Ceramic*

Zirconia was introduced due to its higher fracture toughness and bending strength. However, pure zirconia is an unstable material exhibiting three crystalline phases: monoclinic, tetragonal, and cubic. The change between the three phases results in large volume changes and decreases the mechanical properties of the material considerably because of cracking on cooling. Adding oxides during the tetragonal phase stabilizes zirconia. Yttrium-stabilized tetragonal polycrystalline zirconia (Y-TZP) has a fine grain size and offers the best mechanical properties. The tetragonal phase that is the most resistant tends to transform into the monoclinic phase. This phenomenon explains the higher resistance of zirconia to shock but it also explains its lower sliding resistance properties and its unstable situation over time.<sup>11</sup> Another concern with Y-TZP is its hydrothermal stability. Because Y-TZP is destabilized during the process of steaming sterilization (causing surface roughness of zirconia due to hydrothermal transformation) these ceramics may also undergo slow degradation during long term implantation in the human body. This low temperature degradation is only significant after several years, but can still call the use of zirconia-on-zirconia bearings systems into question.<sup>12</sup>

**Alumina-Matrix-Composite Ceramics (AMC)**

Because of the brittleness of Pure Alumina ceramics and hydrothermal instability of Zirconia, it would seem that a composite of these materials with better mechanical properties would be the way to improve reliability of ceramics implants in orthopedics. De Aza et al.<sup>13</sup> studied crack growth resistance, comparing between 3 types of

ceramics: alumina, zirconia and alumina-zirconia composite. They concluded that alumina-zirconia composites have a higher reliability than the monolithics due to the combined advantages of both alumina and zirconia. Alumina-zirconia nanocomposites with relative low zirconia content present similar hardness values to alumina but are not susceptible to hydrothermal instability.

**Current concept of Aluminum-Matrix-Composite (AMC)**

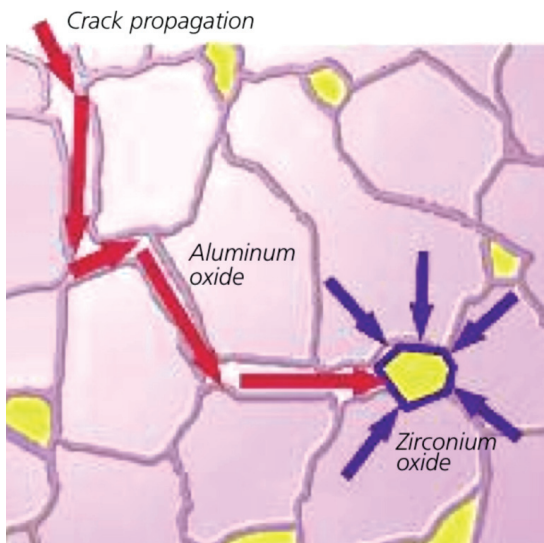
Ceramics are extremely hard, making them wear and scratch resistant however this also indicates a relatively high degree of brittleness, which led to failures in earlier designs. The new Ceramic design Alumina-Matrix-Composite has extremely high fracture toughness and is resistant to crack propagation results as the result of two strengthening mechanisms.

*1. Airbag Function*

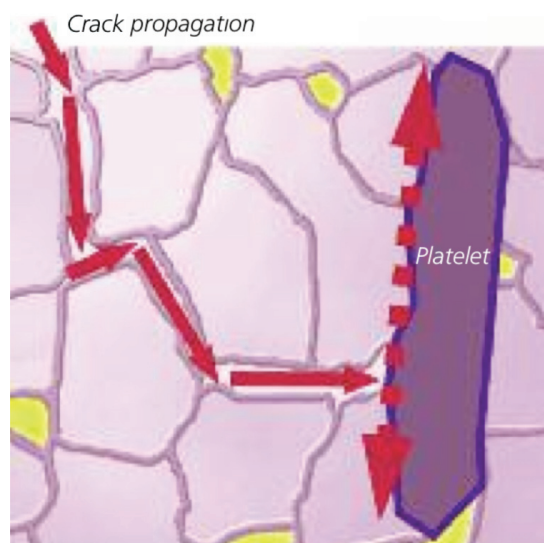
The first toughening mechanism is dispersion of nano-sized, yttria-stabilized tetragonal zirconia particles in a stable, alumina matrix. These particles will be homogeneously distributed and produce local pressure peaks in the area of crack which counteracts crack propagation and works like the airbag system in cars. (Figure 6)

*2. Counteracting Crack Formation*

The second strengthening mechanism is the result of in situ formation of platelet-shaped crystals in the oxide mixture. These platelets prevent cracking and crack propagation by deflecting the crack path and neutralizing crack energy. (Figure 7)



**Figure 6:** The principle of conversion reinforcement: Zirconium oxide particles act like airbags by absorbing impacting forces. (CeramTec)



**Figure 7:** The principle of platelet reinforcement: Platelet-shaped crystals block the propagation of cracks and thereby increase overall strength.

**Discussion**

*1. Squeaking Sounds*

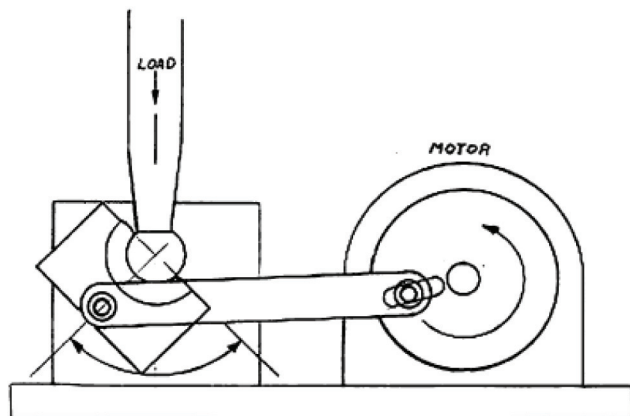
After improvements in ceramic manufacturing, the incidence of ceramic fracture decreased especially after third generation of ceramics. Over the last 5 years, the orthopedic community has been concerned with the noise of ceramic bearings, which was well documented with incidence varying from 1%-20.9%.<sup>14-16</sup> The squeaking noise was defined as a high-pitched noise audible to the human ear.

This disturbing, squeaking sound is like the sound of a new pair of shoes during walking and it annoys and worries patients. Mostly sound occurs during mid range of motion while weight bearing as in simulated stair climb.

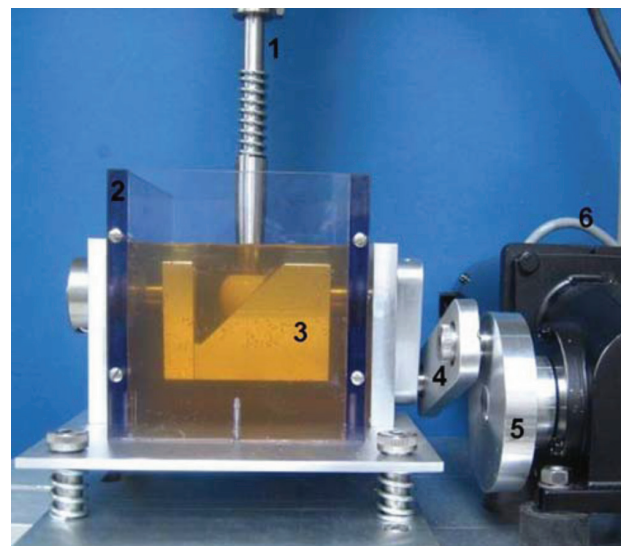
The ten year follow up study by Chevillotte et al.<sup>17</sup> reported 100 Total hip replacements implanted with COC during November 1999 - December 2000; all hips used third generation ceramics (Bilox Forte, CeramTec). To determine the causes and consequences of squeaking, the patients were evaluated by questionnaire. Five patients (five Hips) reported the squeaking sound. The squeaking noise appeared at a mean of 66 months (4 to 85 months)

post surgery with an incidence 2.2% at ten year follow up. The result showed more frequent squeaking sound found in hips in heavier ( $p < 0.0008$ ) and taller males ( $p < 0.0001$ ) and these result are in agreement with Walter<sup>18</sup> and Poggie.<sup>19</sup> Nevertheless, after 10 years of follow-up, patients with squeaking hip did not have any excessive wear, head fracture, cup or stem loosening, abnormal pain, or any limitation of their activities. Harris hip score and Postel-Merle d'Aubigné score were comparable. Squeaking did not disappear in the time but remained stable in intensity. Radiographic assessment did not found malpositioning of the cup in squeaking hips. They concluded that squeaking noise seem to be an isolated phenomenon with no consequence for functional result on longevity at ten years follow up.

In 2009, Chevillotte et al.<sup>20</sup> reported a biomechanical in vitro study of COC bearings surface which intended to identify the potential contributing factors of Hip Squeaking. They used a custom-made hip simulator to assess in vitro hip squeaking (Figure 8, 9). All Acetabulum Components were positioned in 45 degrees abduction and 20 degrees of anteversion. Eight conditions in two separate situations were applied to testing (Table 2 and Table 3).



**Figure 8:** A diagram of the custom-made testing device hip simulator



**Figure 9:** A photograph of the custom-made device is shown.  
 1 = Servo hydraulic testing machine  
 2 = box  
 3 = rotating table  
 4 = bar linkage  
 5 = rotating jig  
 6 = motor

**Table 2:** Situation without lubrication.

Conditions	Squeaking	Number of cycle for squeaking
Normal gait	√	2400
Normal gait (repeated same components)	√	300
High load	√	300
Stripe wear	√	Immediately
Stripe wear and high load	√	Immediately
Material transfer	√	Immediately
Edge wear	√	Immediately
Microfractures	√	4000

**Table 3:** Situation with lubrication

Conditions	Squeaking	Number of cycle for squeaking
Normal gait	0	2400
Normal gait (repeated same components)	0	300
High load	0	300
Stripe wear	0	Immediately
Stripe wear and high load	0	Immediately
Material transfer	√	Immediately; disappear after 30 cycles
Edge wear	0	Immediately
Microfractures	0	4000

Table 2's results show the squeaking sound was easily reproducible in all dry conditions, the squeaking noise was constant and did not disappear with time. In all these dry conditions, when a small amount of lubricant was added, the squeaking sound would disappear but if the lubricant was stopped, the squeaking would reappear and remain. Comparative to lubricated conditions, noise occurred only in material transfer condition (interposed of metal particles between head and liner). This suggested the exact etiology of squeaking is a disruption of fluid lubrication and this phenomenon occurs when the film fluid between the two surfaces in contact is disrupted. The researchers suggested this interruption most commonly results from metal particle transfer as a third body between COC.

Respeto et al.<sup>21</sup> reported the metal debris and stripe wear in four COC total hip replacements after revision surgery due to problems from squeaking noise.

Walter et al.<sup>22</sup> found bands of stripe wear in many ceramic heads after revision surgery without any previous squeaking problem. So, in the conditions where there is a high risk to generate metal wear debris in COC hip replacement (such as neck rim impingement, malpositioning of acetabulum components, short neck design stem or some design of acetabular component with metal rim around the edge) the debris can interrupt the

fluid film lubrication in COC Hip Replacement, resulting in squeaking noise. For the prevention of this disrupting sound the surgeon should pay attention to cup orientation and select the proper design of femoral stem and acetabulum cup.

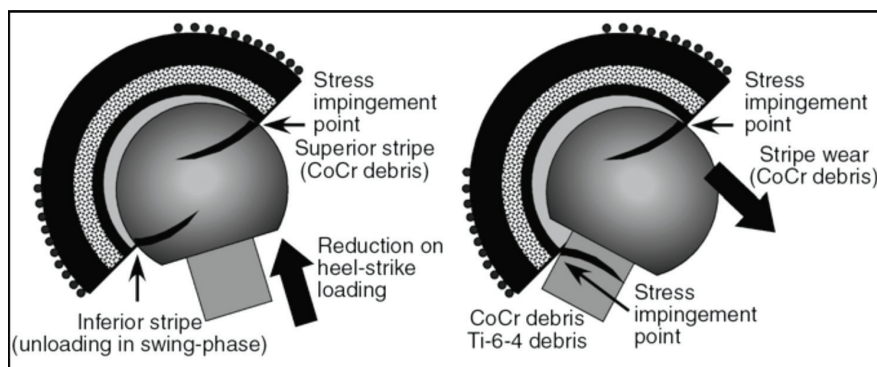
## 2. Stripe wear

Stripe wear is the term used to describe the long, narrow area of damage seen on some femoral heads retrieved from alumina COC hip bearing couples. Stripe wear has been reported in first and second generation alumina bearings<sup>23</sup> However, there were also reports of stripe wear in third-generation alumina ceramic-on-ceramic bearings with well fixed and well positioned acetabular components.<sup>24</sup> (Figure 10)

Some literature reported produce stripe wear was due to edge effects in rigid ceramic-on-ceramic total hip arthroplasty.<sup>26-28</sup> When the hip was slightly subluxated during the swing phase of gait, the cup edge might create an inferior and somewhat equatorial stripe on the femoral head along with a circumferential stripe along the cup rim. During forced reduction at heel-strike, a superior and somewhat equatorial stripe would then be created on the head and the mating cup rim.<sup>19</sup>(Figure 11).



**Figure 10:** Third generation alumina ceramic-on-ceramic bearings with well fixed and well positioned acetabular components



**Figure 11:** During forced reduction at heel-strike, a superior and somewhat equatorial stripe would then be created on the head and the mating cup rim

Nevelos et al.<sup>30</sup> proposed that microseparation of the bearing centers occurs during the swing phase of normal walking and that the subsequent edge loading with heel strike causes the stripe.

In an analysis of 16 retrieved third generation alumina COC bearings, the researcher proposed that stripe wear was caused by edge loading between acetabular liner and femoral head ceramic component.<sup>31</sup> The pattern of wear stripes on the heads and liners showed that the majority do not occur with normal walking; instead they probably occur with edge loading when the hip is flexed such as in rising from a chair or climbing a high step. The mean volumetric wear rates of COC bearings in that study were 0.7 mm<sup>3</sup> per year (running-in). For the effect of alumina ceramic wear, in vitro study on the biologic activity of ceramic particles suggests that they will not be more destructive than polyethylene particles.<sup>32</sup>

The wear particles produced by alumina ceramic on-ceramic bearings are not in the correct size range (0.1–1 micrometer) to stimulate macrophages to produce TNF. For this reason, volume of wear debris from stripe wear will neither be related to osteolysis nor to bearing failure.<sup>31</sup>

### Ceramics Fracture

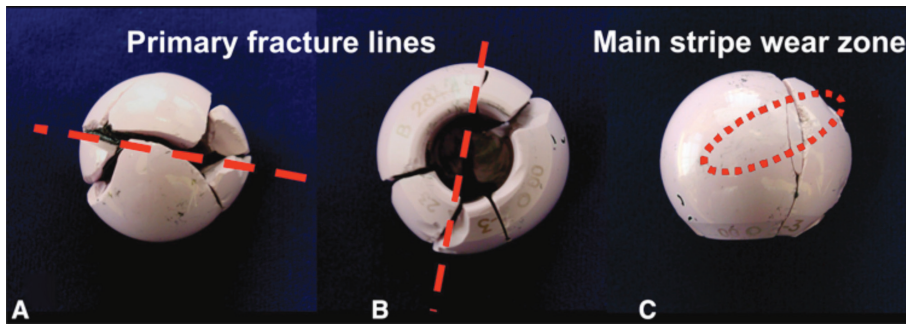
Total hip arthroplasty is often a successful orthopaedic surgical procedure. To improve longevity of prosthesis, many alternative bearings have been explored. One attractive choice is alumina ceramic-on-alumina bearings due to its properties of low friction, high wear resistance, and good biocompatibility. On the other hand, ceramic on ceramic bearings have problems of fracture of a ceramic head and/or liner. Many attempts were made to improve alumina material, that was associated with high rates of fracture as reported in the 1970s (Table 4).<sup>32,33</sup>

**Table 4:** Summary of the mechanical properties of the material used in ceramic-on-ceramic bearings over the past 40 years

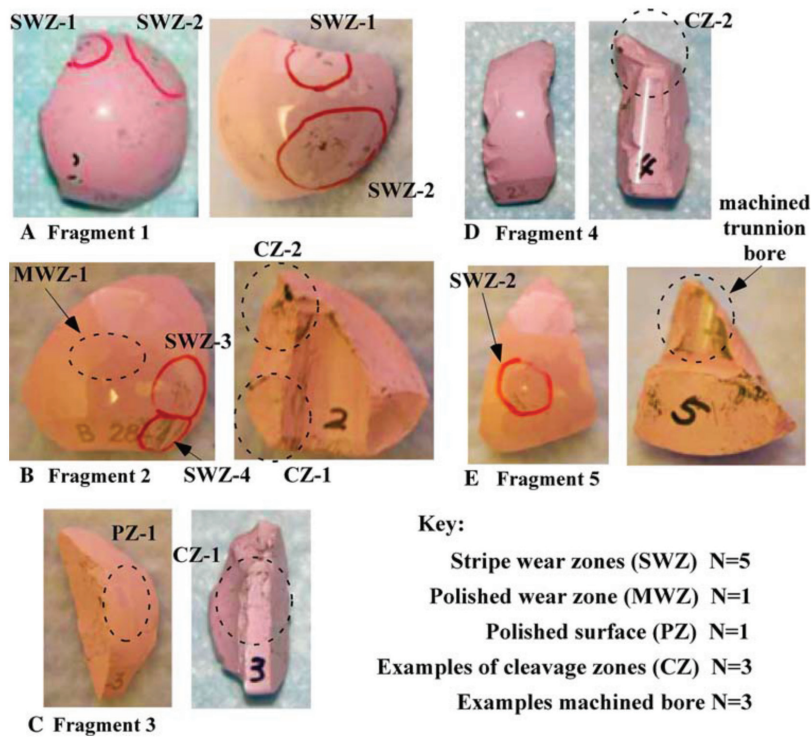
property	Alumina 1970s	Alumina 1990s	Alumina/Zirconia composite 2000s
Bending strength (MPa)	400	580	1150
Fracture toughness (MPa m <sup>1/2</sup> )	4	4.3	8.5
Vickers Hardness HVQ (GPa)	20	20	19
Average grain size (µm)	7.2	1.8	0.6
Young's Modulus (GPa)	380	380	350
Hot isostatic pressing	no	yes	yes
Proof testing	no	yes	yes

Improvements of second-generation ceramics included purification of alumina powder, leading to smaller grain size. This, along with refined manufacturing, increased the density, resulting in decreased fracture rates to 0.014%.<sup>34-36</sup> Third generation fracture rates were reduced to 0.004%.<sup>34-36</sup> In the 2000s, the introduction of alumina/zirconia composite materials showed improvement in mechanical properties For this reason, the reported incidence

of alumina femoral head fractures has decreased. The rate of fracture of femoral heads with this material is reported by the manufacturer to be 1 in 50,000.<sup>37</sup> In 2010, Lombardi et al.<sup>38</sup> reported atraumatic fracture of AMC femoral head. The analysis of the fractured alumina matrix composite femoral head demonstrated the surface roughness increased minimally from new condition (3 nm) to the main wear zone (5 nm) (Figure 12, 13).



**Figure 12A-C:** Overview of fracture fragment from a 28-mm delta from (A) polar view, (B) view of the base, and (C) side view of the stripe wear zone. The dominant fracture plane is indicated by dashed lines in the polar and basal views. The large stripe wear zone crosses over three of the fragments at the angle indicated by the dashed ellipse on the side view



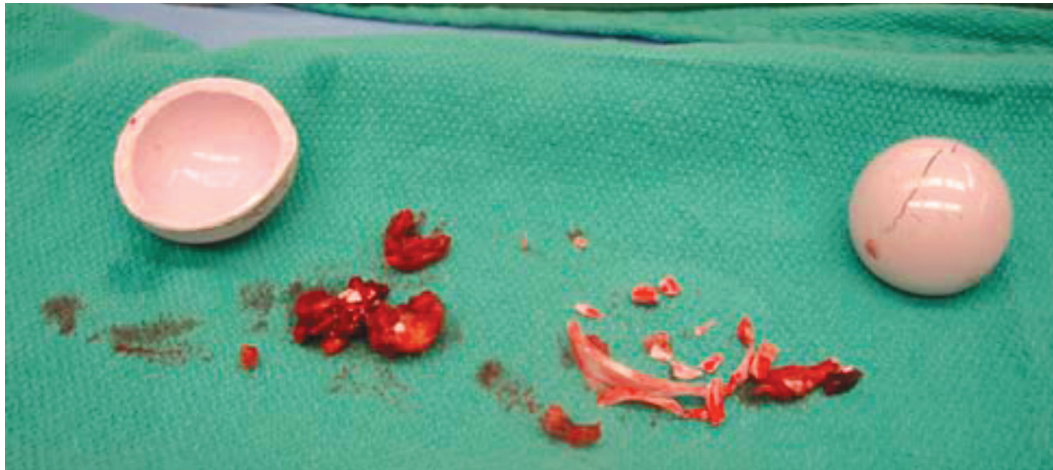
**Figure 13A-E:** Photographs show five of the largest of seven fragments (A-E) from a fractured 28 mm 'Delta' ball. The circles indicate site of analysis for polished main wear zone (MWZ), stripe wear zones (SWZ), metal contamination, machined taper bore and fracture cleavage regions (CZ).

Hamilton et al.<sup>39</sup> also reported the overall rate of post-operative ceramic liner fracture was 1.1% (two of 177). The authors presumes most liners failed as a result of eccentric or incomplete seating of the modular ceramic liner within the metal acetabular shell. Improper positioning and impaction may generate uncontrolled peak stresses in the ceramic, which may lead to fracture<sup>40</sup> (Figure 14).

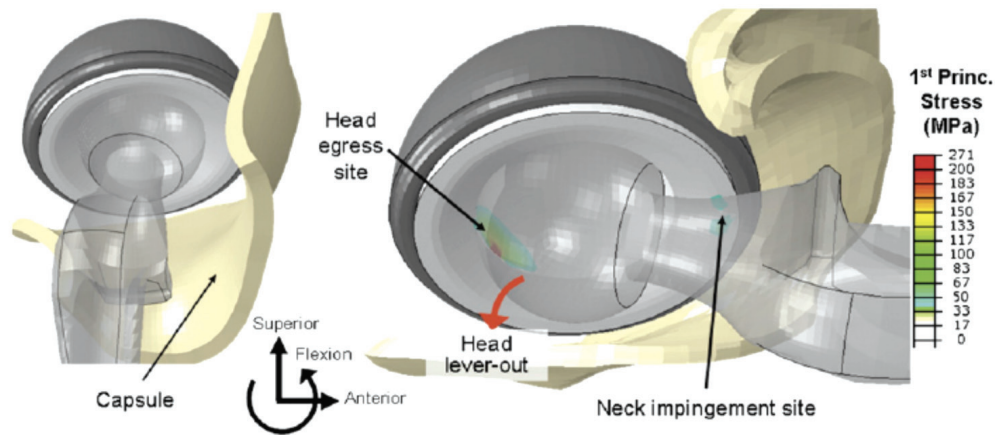
Many predisposing factors for ceramic liner fracture were proposed such as microseparation trauma, and

obesity.<sup>41-43</sup> Fractures apparently due to component impingement were explored.<sup>40,44-46</sup> There were reports that ceramics are vulnerable to fracture due to impact and from stress concentrations (point and line loading) such as those associated with impingement-subluxation.<sup>47</sup> The risk of ceramic femoral head fracture during impingement-subluxation was found to be highly site specific owing to the greatly higher tensile stress at the (edge-loading) egress site compared with that from neck-on-liner impingement (Figure 15).

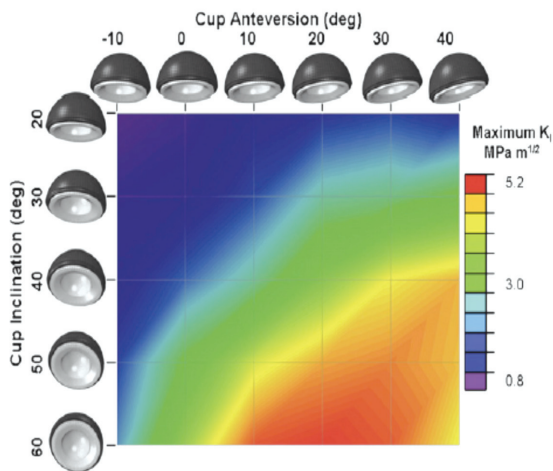




**Figure 14:** The retrieved liner and head show the fractured rim of the liner and ceramic fragments retrieved from the wound.



**Figure 15:** Total hip arthroplasty impingement global FE model. Challenge motions began in full extension (left) and progressed through the prescribed hip angulation sequence, resulting in impingement (right).



**Figure 16:** Computed values of temporal-spatial maximum KI for the stoop challenge demonstrating fracture propensity sensitivity to both cup inclination and anteverision.

Another interesting factor is cup position. The biomechanical study showed ceramic cup fracture propensity is presumably very sensitive to surgical cup positioning. Higher cup inclination and/ or cup anteverision angles gave rise to the higher values of tensile stress if/when subluxation-associated edge loading occurred (Figure 16). The study of the stress on cup position concluded that increased cup inclination and increased anteverision were found to elevate fracture risk. It is reasonable to avoid impingement-subluxation, higher cup inclination and cup anteverision of ceramic bearing to reduce risk of ceramic bearing fracture.

### Conclusion

The tribology properties of low friction, high wear resistance and good biocompatibility make ceramic material the most attractive in hip replacement surgery at the present time. In long term follow up after implantation,

the ceramic couple bearings show the lowest wear rate in many reports, which means low wear debris and less osteolysis.

Specific concerns about ceramics such as fracture, squeaking noise, and stripe wear are still topics of discussion among orthopedic surgeons. Significant advancements in manufacturing processes led to the production of alumina matrix composite ceramics that could eliminate the previous ceramics weaknesses. As for surgical factors, surgeons should perform operations with meticulous technique especially during positioning of the acetabu-

lum component, and insertion of ceramics liner, and they check for any impingement or infolding of anterior-superior capsule, and check the hip tension to prevent hip laxity. These factors can all reduce complications from ceramic implants.

Otherwise, due to the continued high cost of ceramics implant (about double that of metal on polyethylene) it is suggested that good candidates for ceramics implants should be young, active, high demand patients that will need to use their new hip joints long term.

## References

- Willert HG, Bertam H, Buchhorn GH. Osteolysis in Alloarthroplasty of the hip: The role of ultra-high molecular weight polyethylene wear particles. *Clin Orthop Relat Res* 1990;258:95-107.
- Amstutz HC, Campell P, Kossovsky N, et al. Mechanism and clinical significance of wear debris induced osteolysis. *Clin Orthop Relat Res* 1992;276:7-18.
- Boutin P. Total Arthroplasty of the Hip by Fritted Aluminum Prosthesis : Experimental study and 1st Clinical Applications. *Rev Chir Orthop Reparatrice Appar Mot* 1972;58:229-46.
- Oonishi H, Clarke IC, Good V, et al. Alumina hip joints characterize by run-in wear and steady-state wear to 14 million cycles in hip-simulator model. *J Biomed Mater Res A* 2004;70:4.
- Nevelos JE, Ingham E, Doyle C, et al. Wear of HIPed and non-HIPed alumina-alumina hip joints under standard and severe simulator testing conditions. *Biomaterials* 2001;22:2191-7.
- Boutin P, Christel P, Dorlot JM, et al. The use of dense Alumina-alumina ceramic combination in total hip replacement. *J Biomed Mater Res* 1988; 22:1203-32.
- Catelas I, Huk O, Petit A, et al. Flow cytometric analysis of macrophage response to ceramic and polyethylene particles: Effects of size, concentration, and composition. *J Biomed Mater Res* 1998;41:600-7.
- Christel PS. Biocompatibility of surgical-grade dense polycrystalline alumina. *Clin Orthop Relate Res* 1992;282:10-8.
- Bierbaum BE, Nairus J, Kuesis D, et al. Ceramic on Ceramic bearings in total hip replacement. *Clin Orthop Relate Res* 2002;405:158-63.
- Hamadouche M, Sedel L. Ceramics in Orthopaedics. *JBJS* 82B:1095-9.
- Hannouche D, et al. Ceramics in Total Hip Replacement. *Clin Orthop Relate Res* 2005;430:62-71.
- Piconi C, Maccauro G. Zirconia as a ceramic biomaterial, a review. *Biomaterials* 1999;20:1-25.
- A.H. De Aza, et al. Crack growth resistance of Alumina, Zirconia and Zirconia toughened Alumina ceramics for joint prosthesis. *Biomaterials* 2002;23:937-45.
- Capello WN, D'Antonio JA, Feinberg JR, et al. Ceramic-on-ceramic total hip arthroplasty: update. *J Arthroplasty* 2008;23:39-43.
- Restrepo C, Parvizi J, Kurtz SM, et al. The noisy ceramic hip: is component malpositioning the cause? *J Arthroplasty* 2008;23:643-9.
- Keurentjes JC, Kuipers RM, Wever DJ, et al. High incidence of squeaking in THAs with alumina ceramic-on-ceramic bearings. *Clin Orthop Relat Res* 2008;466:1438-43.
- Chevillotte C, Pibarot V, Carret JP, et al. Hip squeaking: A 10 years Follow up Study. *J Arthroplasty* 2012;27:1008-13
- Walter WL, O'Toole GC, Walter WK, et al. Squeaking in ceramic-on-ceramic hips: the importance of acetabular component orientation. *J Arthroplasty* 2007;22:496-503.
- Poggie RA, Turgeon TR, Coutts RD. Failure analysis of a ceramic bearing acetabular component. *J Bone Joint Surg Am* 2007;89:367-75.
- Chevillotte C, Trousdale RT, Chen Q, et al. Hip Squeaking : A Biomechanical study of Ceramic-on-Ceramic Bearing Surfaces. *Clin Orthop Relat Res* 2010;468:345-50.
- Restrepo C, Parvizi J, Kurtz SM, et al. The noisy ceramic hip: is component malpositioning the cause? *J Arthroplasty* 2008;23:643-9.
- Walter WL, Insley GM, Walter WK, et al. Edge loading in third generation alumina ceramic-on-ceramic bearings: stripe wear. *J Arthroplasty* 2004;19:402-13.
- Nevelos JE, Prudhommeaux F, Hamadouche M, et al. Comparative analysis of two different types of alumina-alumina hip prosthesis retrieved for aseptic loosening. *J Bone Joint Surg Br* 2001;83:598.
- Nevelos J, Ingham E, Doyle C, et al. Microseparation of the centers of alumina-alumina artificial hip joints during simulator testing produces clinically relevant wear rates and patterns. *J Arthroplasty* 2000;15:793.
- Murali R, Bonar F, Kirsh G, et al. Osteolysis in Third-Generation Alumina Ceramic-on-Ceramic Hip Bearings With Severe Impingement and Titanium Metallosis. *J Arthroplasty* 2008;23:13-9.
- Dorr LD, Zhinian W, Longjohn DB, et al. Total hip arthroplasty with use of the Metasul metalon-metal articulation: Four to seven year results. *J Bone Joint Surg Am* 2000;82:789-98.
- Huo MH, Parvizi J, Gilbert NF. What's new in hip arthroplasty. *J Bone Joint Surg Am* 2006;88:2100-13.
- Walter WL, Lusty PJ, Watson A, et al. Stripe wear and squeaking in ceramic total hip bearings. *Semin Arthroplasty* 2006;17:190-5.

29. Clarke IC, Manley MT. How do alternative bearing surfaces influence wear behavior? *J Am Acad Orthop Surg* 2008;16:S86-S93.
30. Nevelos J, Ingham E, Doyle C, et al. Microseparation of the centers of alumina-alumina artificial hip joints during simulator testing produces clinically relevant wear rates and patterns. *J Arthroplasty* 2000;15:793-5.
31. Walter WL, Insley GM, Walter WK, et al. Edge Loading in Third Generation Alumina Ceramic-on-Ceramic Bearings. *J Arthroplasty* 2004;19:402-13.
32. Fisher J, Stewart T, Tipper J, et al. Functional biological activity and osteolytic potential of wear debris generated in artificial hip joints. Presented at: IMechE 2000, June 13-15; London.
33. Willmann G. Ceramic femoral head retrieval data. *Clin Orthop Relat Res* 2000;379:22-8.
34. Rack R, Pfaff HG. A new ceramic material for orthopaedics. Procs 5th International CeramTec Symposium, February 2000.
35. Inzerillo CV, Garino JP. Alternative bearing surfaces in total hip arthroplasty. *J Southern Orthop Assoc* 2003;12:106-11.
36. Mehmood S, Riyaz JH, Pandit H. Review of ceramic-on-ceramic total hip arthroplasty. *J Surg Ortho Adv* 2008;17:45-50.
37. Tateiwa T, Clarke IC, Williams PA, et al. Ceramic total hip arthroplasty in the United States: safety and risk issues revisited. *Am J Orthop* 2008;37:E26-31.
38. Pandorf T. How important it is to use clean taper fixations? Procs 13th International BIOLOX Symposium: Bioceramics and Alternative Bearings in Joint Arthroplasty, Edinburgh, 2009.
39. Lombardi AV Jr, Berend KR, Seng BE, et al. Delta ceramic -on-alumina ceramic articulation in primary THA: prospective, randomized FDA-IDE study and retrieval analysis. *Clin Orthop Relat Res* 2010;468:367-74.
40. Hamilton WG, McAuley JP, Dennis DA, et al. THA with Delta ceramic on ceramic: results of a multicenter investigational device exemption trial. *Clin Orthop Relat Res* 2010;468:358-66.
41. Min BW, Song KS, Kang CH, et al. Delayed fracture of a ceramic insert with modern ceramic total hip replacement. *J Arthroplasty* 2007;22:136-9 .
42. Sariali E, Stewart T, Mamoudy P, et al. Undetected fracture of an alumina ceramic on ceramic hip prosthesis. *J Arthroplasty* 2010;25:658.e1-5.
43. Hannouche D, Nich C, Bizot P, et al. Fractures of ceramic bearings: history and present status. *Clin Orthop Relat Res* 2003;417:19-26.
44. Poggie RA, Turgeon TR, Coutts RD. Failure analysis of a ceramic bearing acetabular component. *J Bone Joint Surg* 2007;89:367-75.
45. Ha YC, Kim SY, Kim HJ, et al. Ceramic liner fracture after cementless alumina-on-alumina total hip arthroplasty. *Clin Orthop Relat Res* 2007;458:106-11
46. Park YS, Hwang SK, Choy WS, et al. Ceramic failure after total hip arthroplasty with an alumina-on-alumina bearing. *J Bone Joint Surg Am* 2006;88:780-7
47. Toni A, Traina F, Stea S, et al. Early diagnosis of ceramic liner fracture. guidelines based on a twelveyear clinical experience. *J Bone Joint Surg Am* 2006;88:55-63.
48. Hasegawa M, Sudo A, Hirata H, et al. Ceramic acetabular liner fracture in total hip arthroplasty with a ceramic sandwich cup. *J Arthroplasty* 2003;18:658-61.
49. Elkins JM, Pedersen DR, Callaghan JJ, et al. Fracture Propagation Propensity of Ceramic Liners During Impingement-Subluxation. *J Arthroplasty* 2012;18:520-6.