

# We are IntechOpen, the world's leading publisher of Open Access books Built by scientists, for scientists

3,700

Open access books available

108,500

International authors and editors

1.7 M

Downloads

Our authors are among the

154

Countries delivered to

TOP 1%

most cited scientists

12.2%

Contributors from top 500 universities



WEB OF SCIENCE™

Selection of our books indexed in the Book Citation Index  
in Web of Science™ Core Collection (BKCI)

Interested in publishing with us?  
Contact [book.department@intechopen.com](mailto:book.department@intechopen.com)

Numbers displayed above are based on latest data collected.  
For more information visit [www.intechopen.com](http://www.intechopen.com)



## Fuel Cell Hybrid Electric Vehicles

Nicola Briguglio, Laura Andaloro, Marco Ferraro and Vincenzo Antonucci  
*CNR-ITAE, Via Salita S. Lucia sopra Contesse, Messina, Italy*

### 1. Introduction

Direct combustion of fuel for transportation accounts for over half of greenhouse gas emissions and a significant fraction of air pollutant emissions. Because of growing demand, especially in developing countries, emissions of greenhouse and air pollutants from fuels will grow over the next century even with improving of technology efficiency. Most issues are associated with the conventional engines, ICEs (internal-combustion engines), which primarily depend on hydrocarbon fuels. In this contest, different low-polluting vehicles and fuels have been proposed to improve environmental situation. Some vehicle technologies include advanced internal combustion engine (ICE), spark-ignition (SI) or compression ignition (CI) engines, hybrid electric vehicles (ICE/ HEVs), battery powered electric vehicles and fuel cell vehicles (FCVs). Fuel cell vehicles, using hydrogen, can potentially offer lower emissions than other alternative and possibility to use different primary fuel option (Ogden, 2005) (Fig. 1).

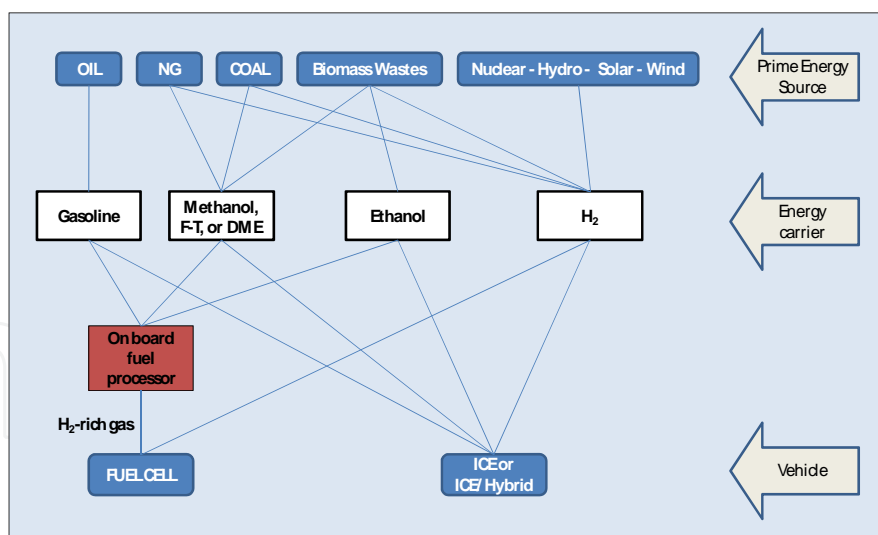

Fig. 1. Alternative fuel vehicle pathways.

A fuel cell vehicles fed by pure hydrogen are a “zero emission vehicle”, in fact the only local emission are water vapour. But in this case it is important to consider the full fuel cycle or “well-to wheels” emissions (fuel production, transport and delivery emissions). Primary source for hydrogen production is crucial for the environmental performance of vehicles. Hydrogen produced from renewable energy (i.e. wind or solar power connected with electrolysis process) and used in fuel cells can reduce significantly emissions. Recent studies

concerning alternative fuels have been identified the fuel cell vehicles, using hydrogen, as the most promising technology with reference to fuel cycle emissions. An analysis for reductions in emissions and petroleum use is reported in following figure for different hydrogen FCVs pathways.

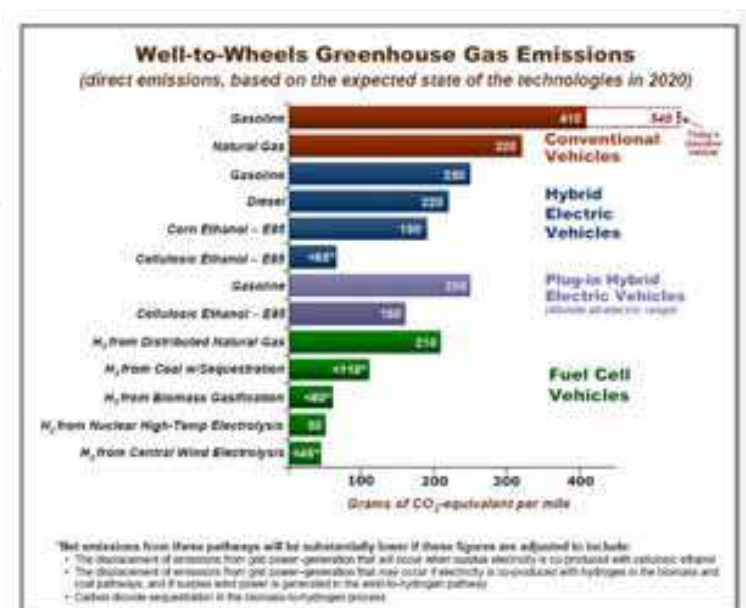

Fig. 2. Well to wheels analysis of potential reduction in greenhouse gas emissions through the hydrogen from different sources. (DOE 2009, 2010)

In order to develop technologies in ultra-low-carbon vehicles, European Commission considers three principal power train:

- alternative fuels to burn in combustion engines to substitute gasoline or diesel fuel include liquid biofuels and gaseous fuels (including LPG, CNG and biogas);
- Electric vehicles;
- Hydrogen fuel cell vehicles.

Advanced vehicles with internal combustion engines may not achieved full decarbonisation alone (McKinsey & Company 2010). It is therefore important to develop different technologies to ensure the long-term sustainability of mobility in Europe.

According with this strategy, hydrogen fuel cell vehicles and battery electric vehicles have similar environmental benefits (European Commission COM(2010)186).

Today, in the light of numerous tests in a customer environment (500 passenger cars – both large and small – covering over 15 million kilometres and undergoing 90,000 refuellings, McKinsey & Company, 2010) FCVs may be considered technologically ready. Moreover, they are still expensive and further research is needed to bring costs down. To become competitive with today's engine technologies, FCVs must reach large enough markets to reduce the cost via mass production. The figure 3 reports the most important technological challenges of FCVs for commercialization.

Despite great improvements in automotive fuel cell system of last years, significant issues must be still resolved. These challenges include:

- Development and cost of hydrogen refuelling infrastructures for direct-hydrogen FCVs;
- Storage systems for hydrogen simultaneously safe, compact and inexpensive;
- Cost reduction in fuel cell stack and durability;

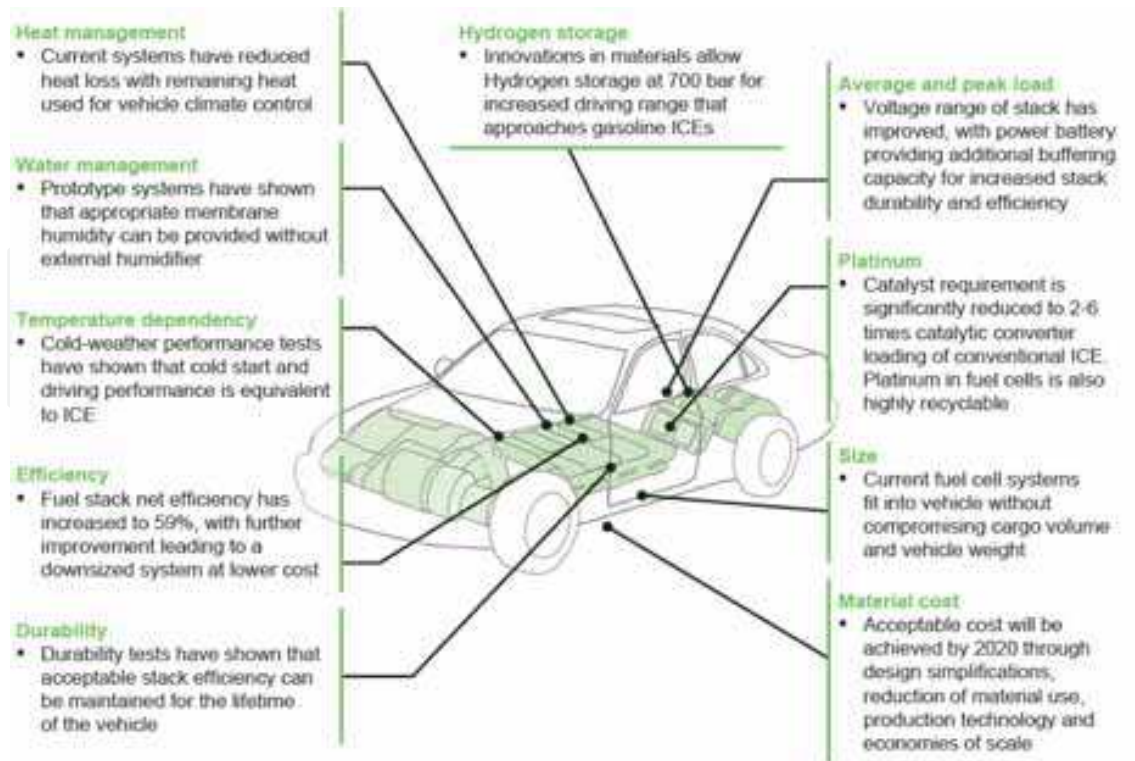

Fig. 3. FCVs: from demonstration to commercial deployment (McKinsey & Company, 2010).

The U.S. Department of Energy (DOE) is working towards activities that address the full range of technological and non-technological barriers facing the development and deployment of hydrogen and fuel cell technologies. The following figure shows the program’s activities conducted to overcome the entire range of barriers to the commercialization of hydrogen and fuel cells.

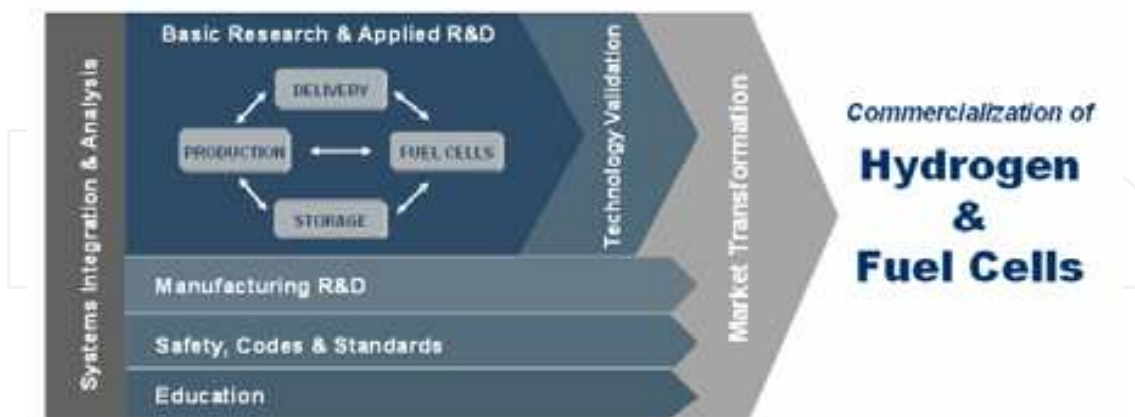

Fig. 4. The DOE program’s activities for fuel cell commercialization.

Regarding the stacks, the targets are to develop a fuel cell system with a 60 percent of efficiency and able to reach a 5000-hours lifespan, corresponding to 240000 km at a cost of \$30/ kW (at large manufacturing volumes) by 2015 (fig. 4.). The Program is also conducting RD&D efforts on small solid-oxide fuel cell (SOFC) systems in the 1-to 10-kW range, with possible applications in the markets for auxiliary propulsion units (APUs).

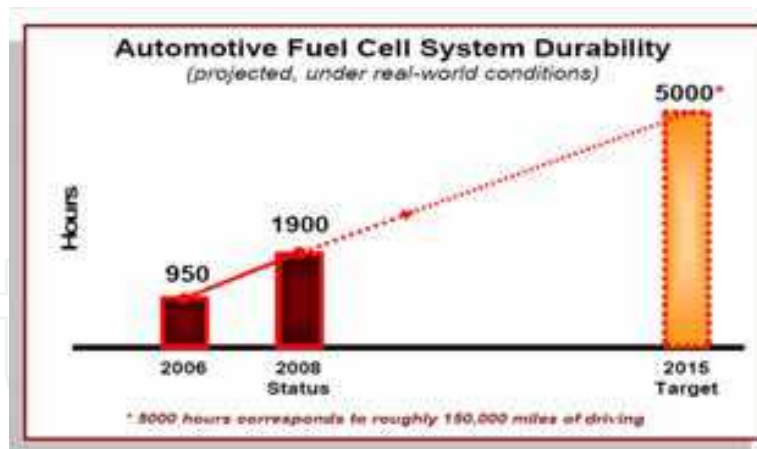

Fig. 5. Target of durability of FCVs in order to reach 240000 km (150000 miles). (DOE 2009).

DOE targets for transportation applications were derived with information from FreedomCAR and Partnership, a collaborative technology organization of Chrysler Group LLC, Ford Motor Company and General Motors Company. In table 1 are showed the targets of direct hydrogen fuel cell power systems.

Characteristic	Units	Target 2015 <sup>a</sup>
Energy efficiency @ 25% of rated power <sup>b</sup>	%	60
Energy efficiency @ rated power	%	50
Power density	W/ L	650
Specific power	W/ kg	650
Cost <sup>c</sup>	\$/ We	30
Transient response (time from 10% to 90% of rated power)	s	1
Cold start up time to 50% of rated power @ -20°C ambient temperature @ +20°C ambient temperature	s	30
	s	5
Start up and shut down energy <sup>d</sup> from -20°C ambient temperature from +20°C ambient temperature	MJ	5
	MJ	1
Durability with cycling	hours	5,000 <sup>e</sup>
Unassisted start from low temperatures <sup>f</sup>	°C	-40

<sup>a</sup>Targets exclude hydrogen storage, power electronics and electric drive.

<sup>b</sup> Ratio of DC output energy to the lower heating value (LHV) of the input fuel (hydrogen). Peak efficiency occurs at about 25% rated power.

<sup>c</sup> Based on 2002 dollars and cost projected to high-volume production (500,000 systems per year).

<sup>d</sup> Includes electrical energy and the hydrogen used during the start-up and shut-down procedures.

<sup>e</sup> Based on test protocols in Appendix D.

<sup>f</sup> 8-hour soak at stated temperature must not impact subsequent achievement of targets.

Table 1. DOE targets for automotive application of direct hydrogen fuel cell power systems (DOE, 2010).

An other important issue in fuel cell vehicles commercialization is hydrogen storage. Currently, compressed hydrogen is the principal technology used on board but the research

is addressed towards advanced materials able to store hydrogen at lower pressures and near ambient temperature, in compact and light weight systems (metal hydrides, chemical hydrogen storage and hydrogen sorption).

In this chapter the prospects of fuel cell in transport application will be discussed and particular attention will be paid to the CNR ITAE experiences. CNR ITAE is the National Council Research of Italy that studies advanced technologies for energy. The Institute is involved in different demonstration projects regarding the development of fuel cell hybrid electric vehicles (FCHEVs) and in particular minibus, citycar, bicycle and tractor. Some kind of projects are addressed to different markets, in particular the so-called “early markets” are dealt with. In this case the powertrain is electric and hybrid because it is composed by known technologies, like batteries, but also by supercaps and fuel cells that are innovative technologies. Fuel cells have a small size because they are used like on board batteries recharge, “range extender” configuration, allowing to increase the range of traditional electric vehicles. The lower fuel cell power means a reduction in terms of stack size then a less cost of it as well as hydrogen storage amount.

Other one kind of projects is instead addressed to a future market. The configuration used is the “full power fuel cell”, in which FCVs have a big size of power close the electric motor power. The full power fuel cell vehicles are provided with innovative components such as radio systems (information technology systems - ITS) able to broadcast with other similar vehicles and fleet managing station. They represent a new concept of vehicle because they are a high-tech products, equipped with hardware and chassis made with new light materials and with a platform having interchangeable upper bodies.

## 2. Fuel cell technology for transport applications

Proton Exchange Membrane Fuel Cells (PEMFC) are the most used technology in FCVs. In part, this dominance is due to large number of companies interested in PEMFC development. In technical terms, PEM fuel cells have high power density, required to meet the space constraints in vehicles, and a working temperature of about 70 °C allowing a rapid start-up. The electric efficiency is usually 40-60% and the output power can be changed in order to meet quickly demanded load. Other characteristics of PEMFC systems are compactness and lightness. As a result of these characteristics, PEMFC are considered the best candidates for mobile applications. The disadvantages of this technology are sensitive to fuel CO impurities and expensive catalyst, higher CO levels result in loss of fuel cell performance. Furthermore, the electrolyte must be saturated with water and the control of the anode and cathode streams therefore becomes an important issue. In transport applications this technology is used in hybrid configuration with electricity storage devices, such as batteries or super capacitors.

Today real competitors in transport market are SOFC (Solid Oxide Fuel Cell) systems, particularly suited for auxiliary power unit (APU) such as heating, air conditioning, etc (heating, air-condition etc..). SOFCs are characterised by their high working temperature of 800-1000°C. There are two configuration of stack, tubular and planar. The tubular concept is suitable for large-scale stationary applications while the planar concept is preferred for transport application tanks to the higher power density. The SOFC applications in vehicles are limited to APU rule due to long start-up time and slow dynamic behaviour caused by high temperature operation. However, it is also considered an important option for auxiliary power units on board of vehicles in the 5 kW range. The power density of the SOFC is in the range of 0.15-0.7 W/ cm<sup>2</sup> but high temperature corrosion is a problem that

requires the use of expensive materials. Delphi automotive and BMW companies have already been examined this technology in prototype vehicles.

Other different typologies of fuel cells used in transport are the AFC (Alkaline Fuel Cell). The use of this kind of FC is, today, limited if compared with other FC technologies. Several units are installed in niche transport sectors such as motorbikes, forklift trucks, marine and space applications. Several installations (80%) were introduced before 1990 and used in space applications especially. The rest were installed in transportation development and demonstration vehicles. After 1990 some units were installed in light duty, portable and small stationary end-use. When PEM units were introduced in the 1980s, the interest was shifted to this fuel cell alternative, particularly for the transport sector. Recently, some companies have been considered AFC technology for operation in stationary and portable application. The main problem of this technology is the carbon dioxide poisoning: small amounts of CO<sub>2</sub> reduce the conductivity of electrolyte. As consequence of this, pure hydrogen must be used. Besides, air needs to be cleaned from CO<sub>2</sub>, which limits the application for terrestrial applications considerably.

Finally, DMFC (Direct Methanol Fuel Cell) technology is used to power portable applications and in some niche transport sector such as marine, motorbikes and APU. In the year 2000, Ballard and Daimler Chrysler installed a DMFC system on a light duty but after no other vehicles have been developed. Some years ago DMFC had been considered a promising technology because methanol, that is a liquid fuel, allows to maintain all refuelling infrastructures. However if compared with PEMFC, the DMFC power density is lower but the high energy density of fuel (methanol) has potential to replace batteries with micro fuel cell systems.

FC technology	Working temperature	Efficiency	Automotive applications	Advantages	Disadvantages
PEM	70-90°C	50-60%	Buses, Niche transport, light duty vehicles, APU (niche transport vehicles)	high power density rapid start-up capacity to meet quickly demand load Solid electrolyte	sensitive to fuel CO impurities expensive catalysts
SOFC	700-1000 °C	50-60%	APU ((niche transport vehicles)	Tolerance to fuel CO impurities Fuel flexibility Solid electrolyte	Long start-up Slow dynamic load behaviour High temperature corrosion of components
DMFC	60-130°C	40%	APU (niche transport vehicles)	Storage of liquid fuel (methanol)	Low power density high noble metal loadings
AFC	90-100 °C	50-60%	APU (niche transport vehicles)	Low cost components	Sensitive to CO <sub>2</sub> in fuel and air

Table 2. Fuel Cell technologies for transport applications.

Table 2 summarizes fuel cell technologies for transport sector by application. The used technologies are PEM, SOFC, AFC and DMFC while PAFC (Phosphoric Acid Fuel Cell) and MCFC (Molten Carbonate Fuel Cell) systems are generally suitable to provide stationary power and generation of heat for residential and industrial applications.

### 3. The current market of FCVs

Fuel cell vehicles are still in development and demonstration phase. All automakers have substantial development programs underway. Most attention is focused on the use of PEMFCs for transportation applications. Actually, PEM technology is used in different application as shown in figure 5. The majority of units installed globally are used for portable applications. Niche transportation, light duty vehicles and buses are only around 15% of total installed units because the request is low compared to the other markets.

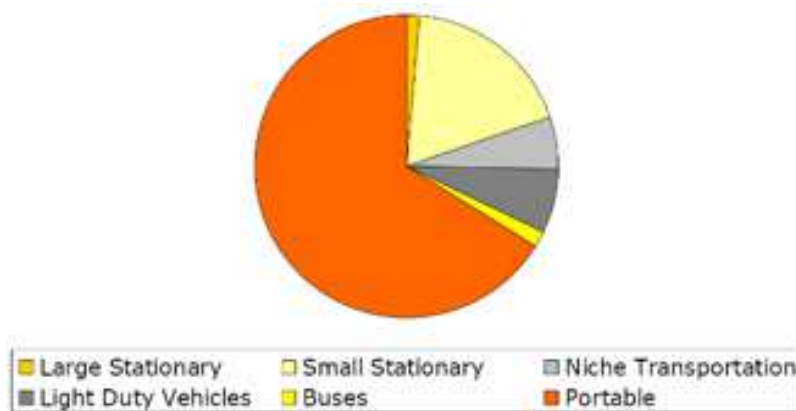

Fig. 6. Percentage of PEM units installed by application (Gemma Crawley, 2006).

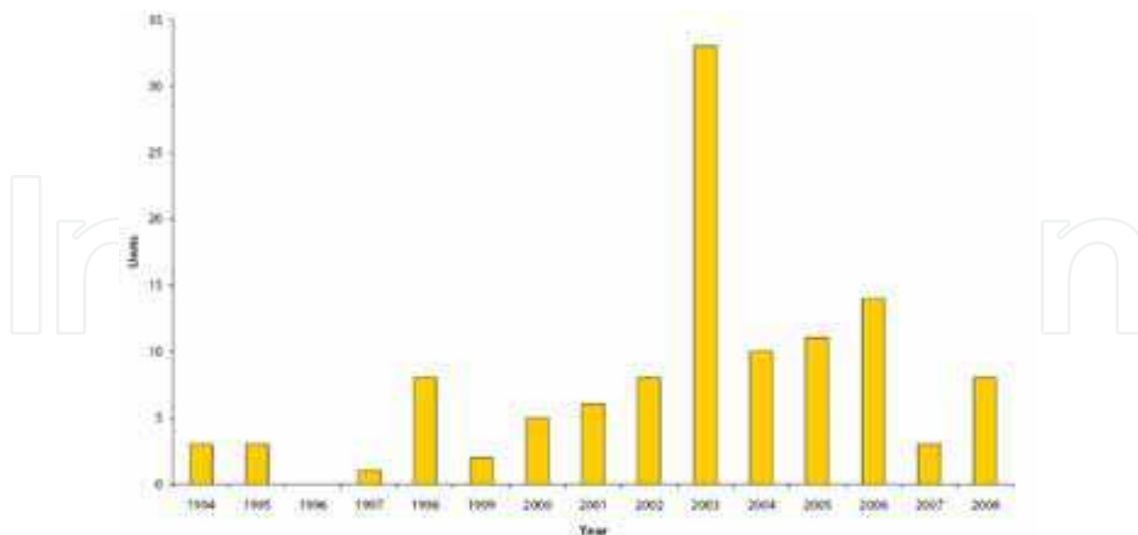

Fig. 7. Buses fuel cells units produced from 1994 to 2008 (Lisa Callaghan Jerram, 2008).

The PEFC systems was chosen for providing primary power train for buses involved in the clean urban transport for Europe (CUTE) (2003-2006). A total of 27 Mercedes-Benz Citaro buses, equipped with fuel cell power train, were used on three continents. Figure 7 shows



the buses units number produced per years, the peak number is in 2003 when started the CUTE project. In term of fuel cell bus deployment, Europe is leader with 53% of total deployments and 17 cities involved in demonstration projects. Asia's projects are focused in Japan, China and South Korea, in USA several activities are presented in California (fig. 8). With regard to the regions of manufacture the situation mirrors the deployments with Europe 67% of total. The reason of that is the CUTE project, supported by Mercedes Benz fuel cell Citaros, and a Belgian fuel cell buses company, Van Hool.

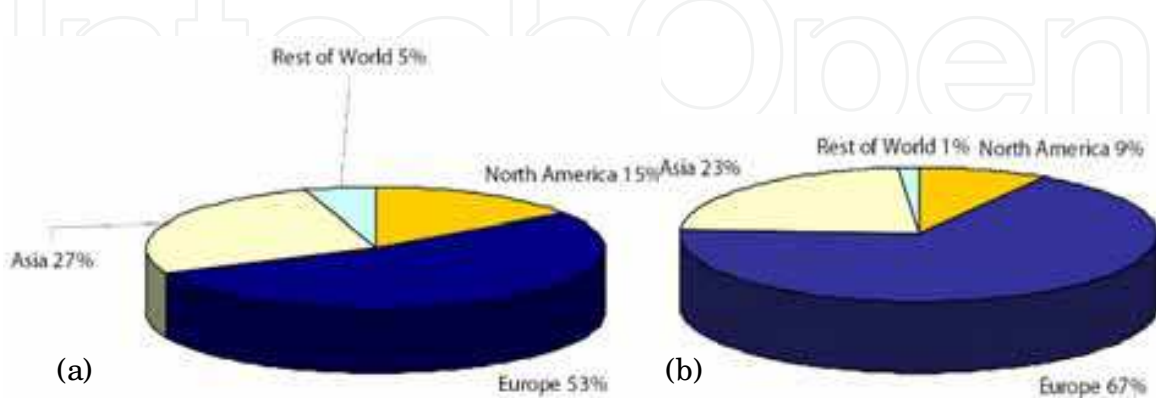

Fig. 8. Fuel Cell bus deployment (a) and region of manufacture (b) from 2003 to 2008 (Lisa Callaghan Jerram, 2008).

Such as in buses market, in duty vehicles the technology choice is PEM. The annual distribution of units is not constant and reflects the pre-commercial nature of this market (fig. 9). Besides, the targets of past are shifted into next years. The main automaker involved in this sector are Honda, General Motors, Nissan, Hyundai-Kia and Toyota.

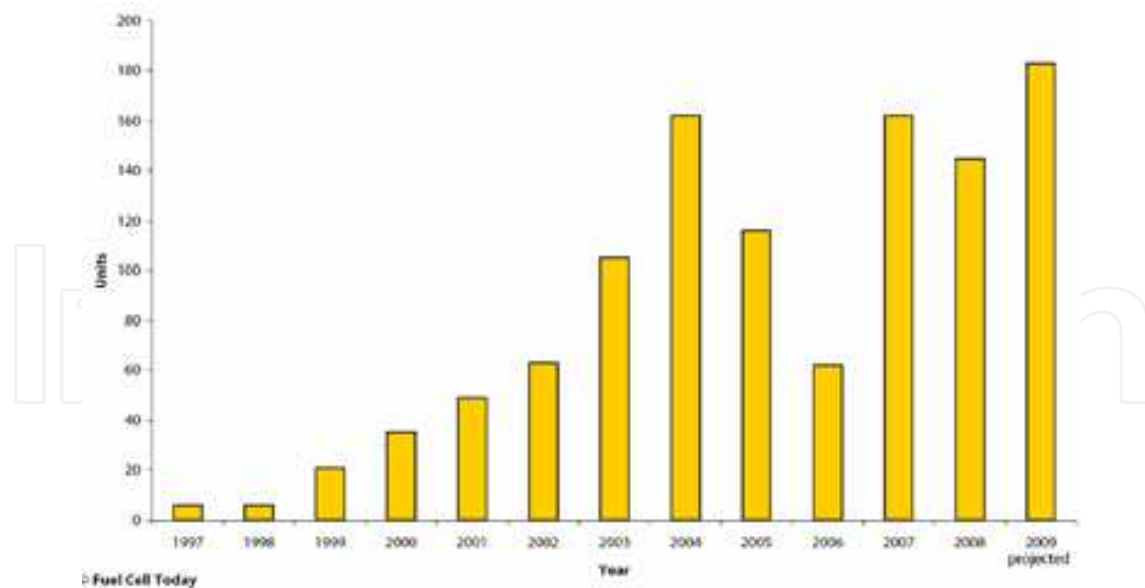

Fig. 9. Annual New Light Duty Vehicle (Lisa Callaghan Jerram, May 2009).

Figure 10 reports the manufacture and deployment percentage by region. For 2007-2009 (projected) Asia and North America have become the major areas of manufacture. California, with the presence of infrastructures and the ZEV mandate, is a leading market for fuel cell vehicles. Germany, due to government programs, is a promising country for fuel

cell market. With regard to Asia, fuel cell vehicles are used as small fleets leased to government officials.

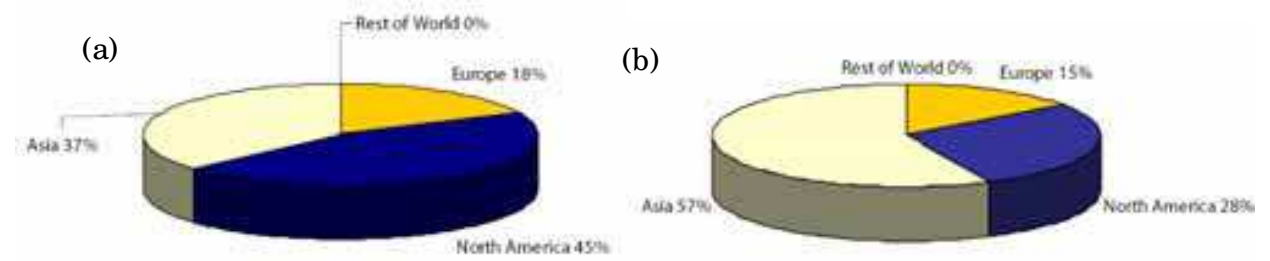

Fig. 10. Light Duty Vehicle deployment (a) and region of manufacture (b) 2007-2009 (Lisa Callaghan Jerram, May 2009).

The Honda fuel cell concept car is shown in figure 11 with illustrates how modern fuel cell systems can be packaged into a small light-duty vehicles. Like most FC cars, the vehicle is equipped with a compressed hydrogen storage system.

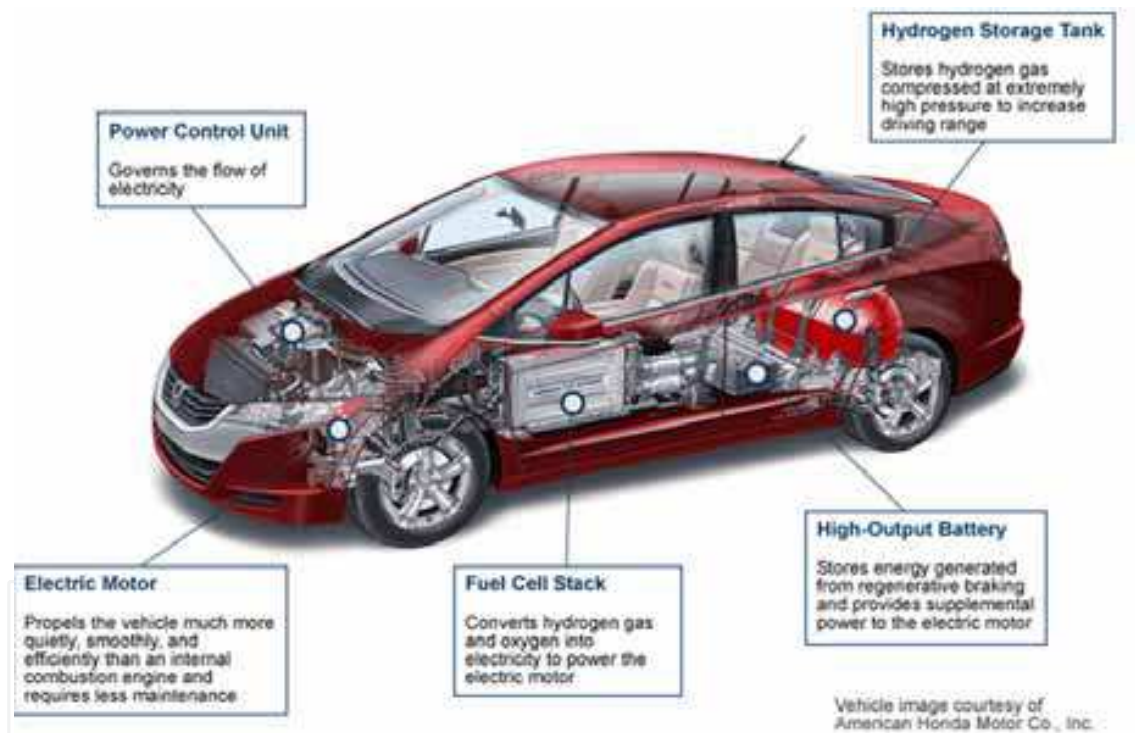

Fig. 11. Fuel cell concept car (manufacturer Honda, type FCX Clarity).

In table 3 the last fuel cell vehicles produced by some carmakers are listed. FC manufacture, range and fuel type are reported.

Transport sector comprises applications as aircraft and aerospace, scooters, motorbikes and other two- and three-wheeled vehicles, materials handling vehicles such as forklift trucks, trains and the ‘other’ category, including such applications as wheelchairs and mobility assistance vehicles. Annual growth from 2005 through 2008 is showed in figure 12. The units installed in 2008 regard principally materials handling vehicles, scooters and motorbikes and the ‘other’ category including mobility assistance vehicles, each of which saw tens to hundreds of units deployed.

Automaker	Vehicle type	Year	Engine type	FC manufacturer	FC size/type	Range (mi/km)	Fuel type
Audi	Q5 HFC	2010	FC/ battery hybrid	N/ a	131 bhp	N/ a	Compress. hydrogen
AVL list GmbH	AVL FCC: 4-5	2010	EV with FC range extender	N/ a	3 kW PEM	150 km	34L CGH @ 200 bar
BMW	FC/ hybrid electric 1-Series	2009	FC/ battery hybrid	UTC Power	N/ a	N/ a	N/ a
Daimler	Mercedes-Benz F 800	2010	FC/ battery hybrid	N/ a	N/ a	18 mi battery/ plus 375 mi hydrogen	Compress. hydrogen
Fiat/ Alfa Romeo	MiTo	2010	N/ a	N/ a	N/ a	N/ a	N/ a
Fiat	Panda	2007	Fuel Cell	Nuvera	60 kW PEM	200 kW	Compress. hydrogen
Ford Motor Company	HySeries Edge	2007	Fuel Cell plug-in hybrid	Ballard	HySeries Drive	491 km	N/ a
GM	Provoq	2008	FC/ battery hybrid	GM	88 kW PEM	483 km	Compress. hydrogen
Honda	Fc Sport	2008	Fuel Cell	Honda	PEM	N/ a	Compress. hydrogen
Honda	FCX Clarity	2007	Fuel Cell	Honda	100 kW/ PEM	570 km	Compress. hydrogen
Hyundai	Tucson ix35 FCEV	2010	FC/ supercap hybrid	N/ a	100 kW/ PEM	650 km	Compress. hydrogen
Kia	Borrego/ Majoave FCEV	2008	FC/ battery hybrid	Ballard	115 kW/ PEM	685 km	Compress. hydrogen
Microcab Industries Limited	Microcab	2008	Fuel Cell	N/ a	N/ a	160 km	Compress. hydrogen
Morgan	LIFECar	2008	Fuel Cell	QinetQ	22 kW/ PEM	402 km	N/ a
Pininfarina	Sintesi	2008	FC/ battery hybrid	Nuvera	Four 20 kW PEM	N/ a	N/ a
PSA Peugeot Citroen	FiSyPAC	2009	FC range extender	N/ a	N/ a	496 km	N/ a
Renault	Scenic FCV H2	2008	FC/ battery hybrid	Nissan	90 kW	240 km	N/ a
Shanghai Automoti-ve Industry Corp.	Shangha	2007	Fuel Cell	ShenLi	60 kW/ PEM	N/ a	N/ a
Suzuki	SX4-FCV	2008	Fuel cell	GM	80kW/ PEM	250km	Compress. hydrogen
Tecnalia	H2CAR	2008	Fuel cell/ battery hybrid	N/ a	5kW/ PEM	N/ a	Compress. hydrogen
Toyota	FCHV-adv	2008	Fuel cell/ battery hybrid	Toyota FC stack	N/ a	830km	N/ a
Volvo	C30	2010	Fuel cell/ battery hybrid	Powercell Sweden	N/ a	400 km	Hydrogen (reformed onboard from gasoline)
VW	Passat Lingyu	2008	Fuel cell/ battery	SAIC (Shanghai VW parent co.)	55kW/ PEM	300km	N/ a

Table 3. Some recent fuel cell Vehicles prototype by automaker (Fuel cell 2000, 2011).

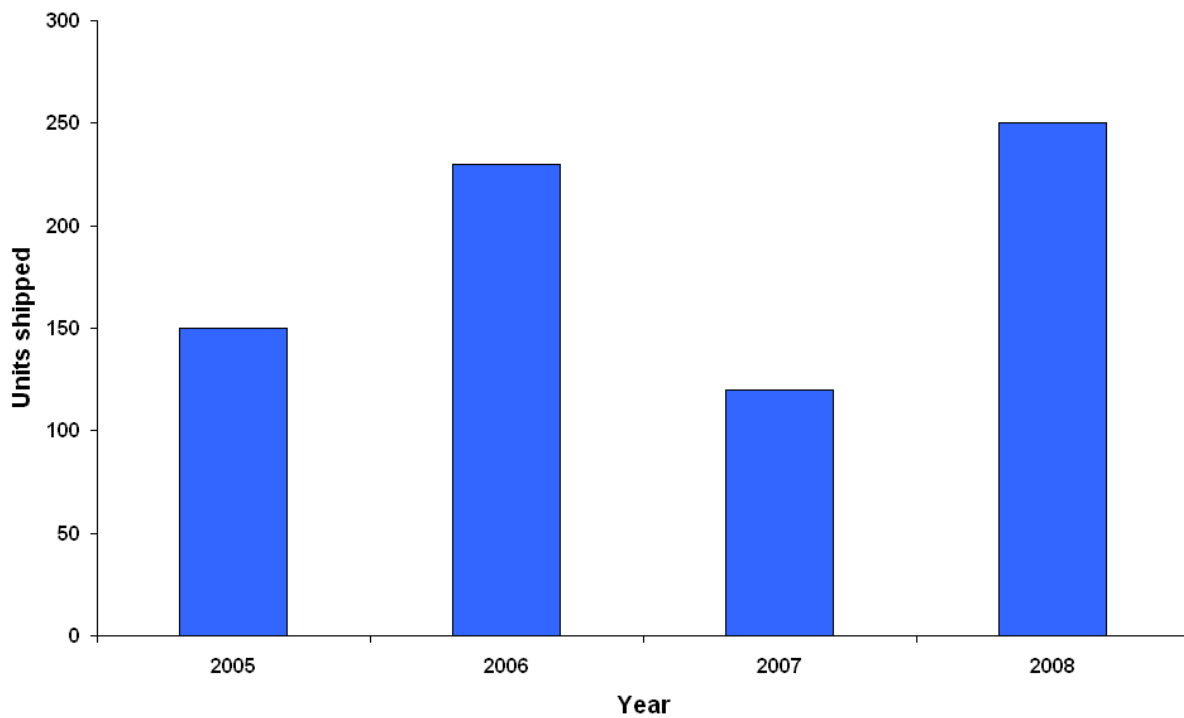

Fig. 12. Niche transportation: annual growth (Jonathan Butler, July 2008).

The technologies used for this application are PEM and DMFC, very little units installed are SOFC (fig. 13). In particular, there is most units PEM in aerospace and aircraft sector, a two thirds to one third split between PEM and DMFC in the scooters and motorbike market. In the materials handling market, almost exclusively PEM units are used. In the ‘other’ category, there are roughly six times the number of DMFC units compared with PEM units.

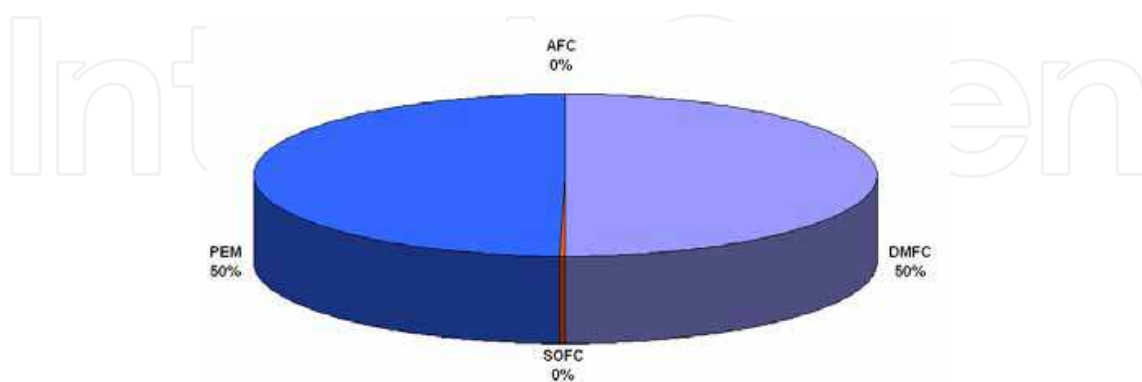

Fig. 13. Percentage of units shipment by technologies (Jonathan Butler, July 2008).

Marine and APU market is another interesting application where fuel cells have about 7000 units installed into 2008. Starting with very low units installed in 2005 the numbers increased during 2007/ 2008.

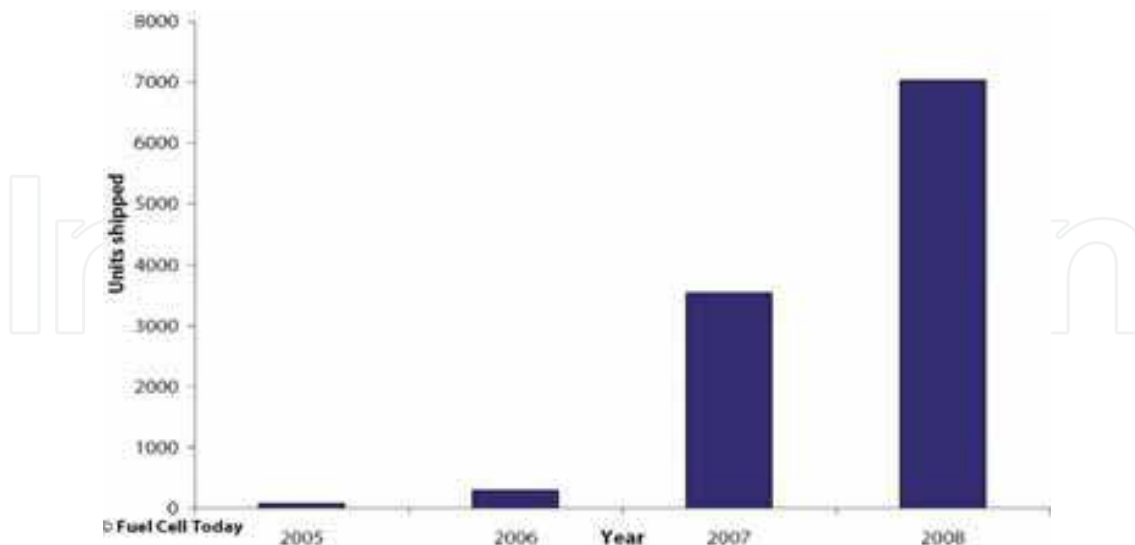

Fig. 14. Fuel cells units installed in niche transportation sector (APU and marine) from 2005 through 2008 (Dr. Jonathan Butler, 2008).

In terms of technology, DMFC is the principal choice thanks to the liquid fuel and flexibility of refilling. The following figure shows the percentage by technology. Number of PEM units are limited to APU applications for on board yachts due to their silent operation.

Very interesting is the SOFC technology used mainly for APU demonstration units for road vehicles and marine vessels. In fact, units installed in this transport sector are higher than in large stationary applications (Gemma Crawley, 2007). In this sector SOFC units are used as APUs to supply auxiliary power to selected vehicles. Companies involved in development of automotive system for fuel cell, as Delphi Automotive Systems, believe in SOFC technology for the high efficiency, simply reforming technology and less stringent fuel requirements. The majority fuel cell manufacturer in transportation sector are indicated in table 4.

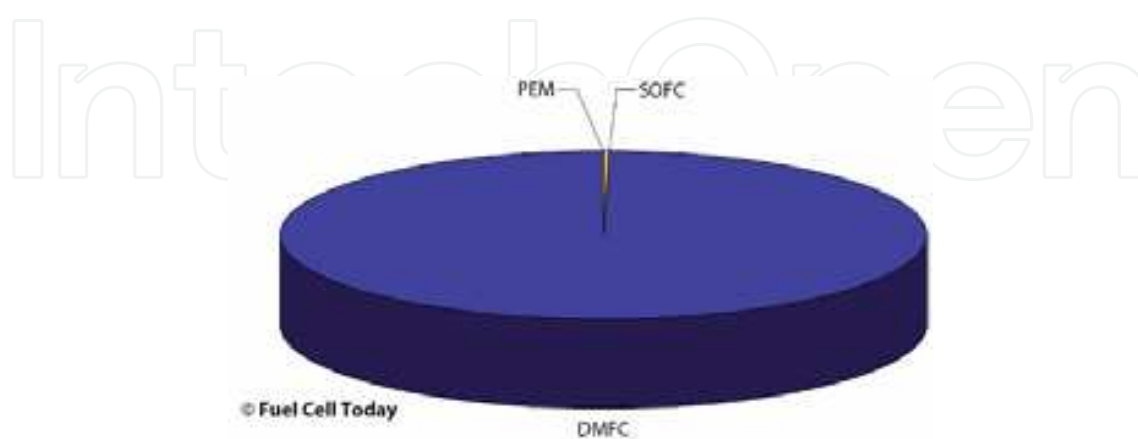

Fig. 15. APU and Marine sectors: percentage by technology 2007/ 2008 (Dr. Jonathan Butler, 2008).

Manufacturer	Application	size	Technology
Ballard	Transportation/ bus/ light mobility	4 - 85 kW	PEM
General Hydrogen	Small/ medium/ large trucks	/	PEM
SFC Smart Fuel Cell	Mobile/ niche transport	600 - 1600 Wh/ day	DMFC
UTC Power	Transportation	120 kW	PEM
Hydrogenics	Mobility application	4 – 65 kW	PEM
Nuvera FC	APU, transportation	5 – 82 kW	PEM
Delphi Automotive System	APU	1-5 kW	SOFC

Table 4. Fuel cell manufacturers for transport applications.

#### 4. Vehicles configuration

Fuel cell vehicles are electric vehicles powered by batteries and fuel cell. There are different configurations for fuel cell hybrid electric vehicles (FCHEVs). In particular the configuration depends on the desired hybridization level and on the fuel cell and batteries rules.

In conventional electric vehicles batteries provide power to the electric motor, in the FCHEVs batteries and fuel cell are connected in a parallel system and together provide power.

Figure 16 shows a fuel cell stack connected with a DC/ DC converter needed to provide a regulated voltage at the output. Battery pack is connected with auxiliary devices and with fuel cell. The DC/ AC inverter converts the direct current (DC) in alternate current (AC) in order to feed electric motor. The motor is able to recover part of energy that would normally be lost due to braking (regenerative braking). This recovered energy is used to recharge batteries.

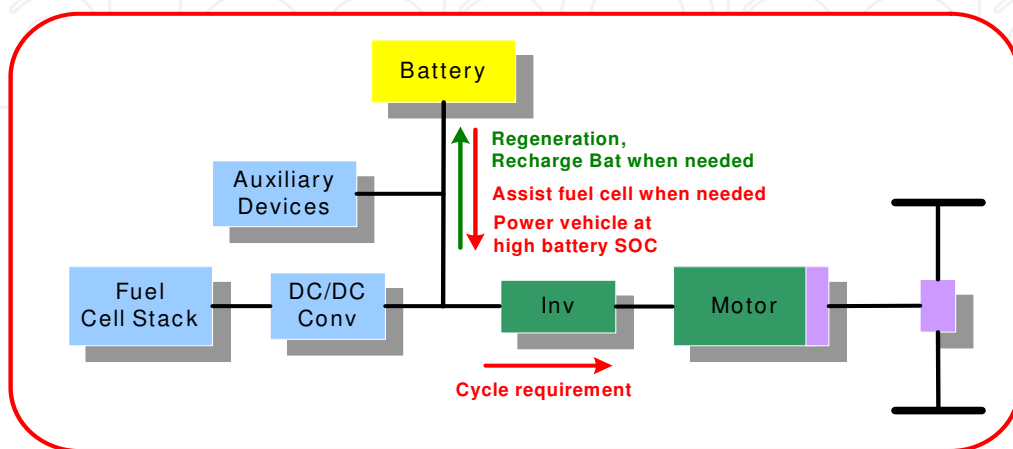

Fig. 16. Fuel Cell Hybrid Electric Vehicle configuration

The sizes of batteries and fuel cell define the hybridization level and the configuration.

A conventional electric vehicle (full battery) presents intrinsic limits like the range (that is function of batteries capacity) and recharge time (about 6-8 hours), that can reduce their use. FCHEVs allow to increase the range, in terms of working hours or distance, because it is a function of the on board stored hydrogen and the hydrogen refuelling time isn't comparable to the batteries recharging time.

In the first configuration, called "*total fuel cell*" or "*full power fuel cell*", the electric drive motor is totally fed by fuel cell and a small battery can be installed just for the vehicle start up or for peak power. In this case the fuel cell power is close the electric motor power. A similar architecture, having a big size of fuel cell, means a great quantity of stored hydrogen (also depending on the required range) and high costs.

Another configuration consists of an architecture in which the fuel cell is used as APU (auxiliary power unit) and provides the electrical power required by the auxiliary devices. In this case the fuel cell size is very small and its function is essentially addressed to cover small loads like air conditioning, electric windows, lights, etc.

Finally, the "*range extender*" configuration is characterized by a small size fuel cell used like on board batteries recharge. This solution, depending on the on board stored hydrogen, allows to increase the range of traditional electric vehicles. Using this configuration it is possible to define a specific batteries recharge strategy; in particular the batteries can be recharged when the electric motor doesn't require load, i.e. during the stops and at the terminus. In some case the fuel cell can contribute to the electric traction providing energy when the vehicle runs also. In this way the fuel cell works in optimal operation conditions at a fixed power, avoiding the load following operation that could cause thermal and mechanical stress of materials.

Moreover, the lower fuel cell power means a reduction in terms of stack size then a less cost of it as well as hydrogen storage amount.

## 5. CNR ITAE challenges and activities

The automotive strategy of CNR-ITAE is to investigate the fuel cell technology in order to evaluate the stack behavior and its integration in a system, addressing the research towards an efficient system interface and architecture trade off. This includes hydrogen stack modules as well as reformat stack modules. The principal issues regard efficiency, cost, durability and manufacturing. The research activities is focused on SOFC and PEM technologies for applications with hydrogen and Reformed hydrocarbon (NG, GPL). In fact, although the long term target is to implement hydrogen as fuel, since the current limited hydrogen infrastructures, other fuel (such as Reformed NG) can be a short term solution (figure 17).

The projects in which CNR ITAE is involved concern electric vehicles realization, having an electric motor like driving force. This kind of projects are addressed to different markets, in particular the so-called "early markets" are deal with. In this case the powertrain is electric and hybrid because it is composed by known technologies, like batteries, but also by supercaps and fuel cells that are innovative technologies. Fuel cells have a small size because are used like on board batteries recharge, "range extender" configuration, allowing to increase the range of traditional electric vehicles. This approach is a way to introduce the FC technology gradually thanks to the lower power and costs.

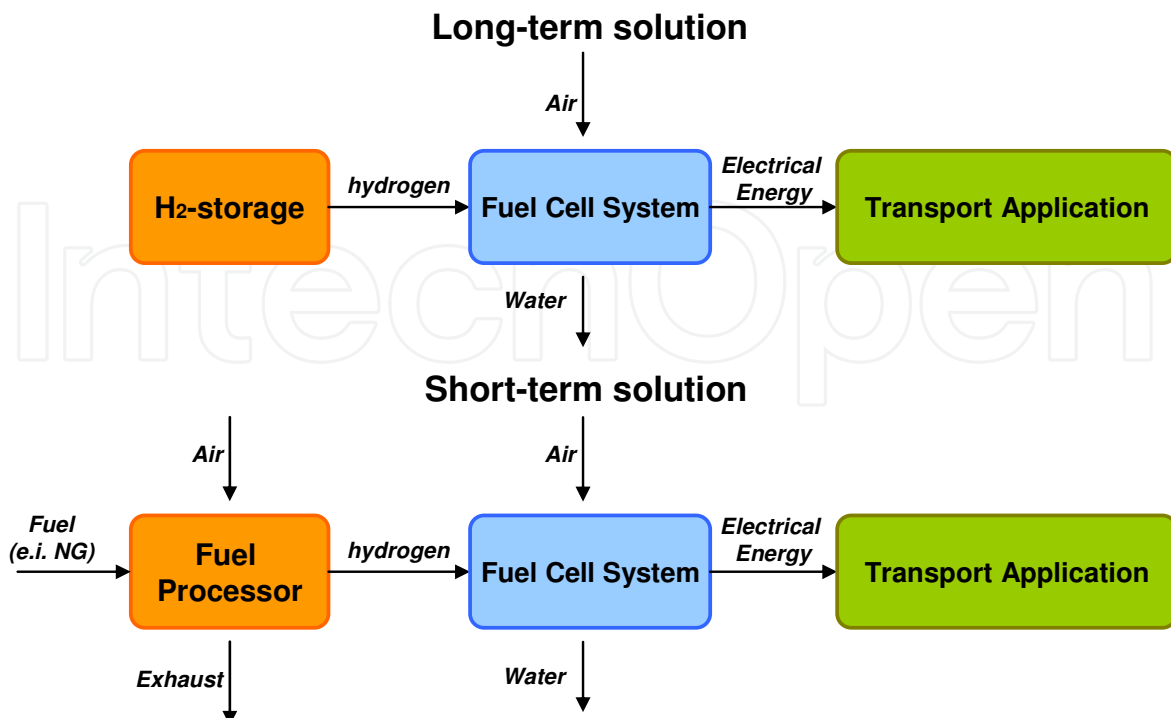

Fig. 17. Fuel options for fuel cell power generation.

The other one kind of projects is instead addressed to a future market. The configuration used is the “full power fuel cell”, in which FCs have a big size of power close the electric motor power. The full power fuel cell vehicles are provided with innovative components such as radio systems (information technology systems - ITS) able to broadcast with other similar vehicles and fleet managing station. They represent a new concept of vehicle because they are a high-tech products, equipped with hardware and chassis made with new light materials and with a platform having interchangeable upper bodies.

Demonstration projects regarding the development of fuel cell hybrid electric vehicles (FCHEVs) and in particular minibus, citycar, bicycle, tractor and airplane. The tractor projects intends to demonstrate that the fuel cell can be applied in the farm context because hydrogen could be produced on site using different methods (biomass, wind energy, photovoltaic). In this case the hurdle of hydrogen distribution is avoided.

The research activities of CNR ITAE are supported by numerous partners involved in fuel cell development. This includes collaborations and with fuel cell developers like Nuvera Fuel Cell, SOFCPower and with industrial partners.

The most of important projects in automotive sector which CNR ITAE is involved are “Meccano”, “BHYKE”, “HY-TRACTOR” and “H-BUS”.

The project, called “MECCANO”, is to develop a highly evolved concept vehicle which offers competitive advantages in terms of optimized ergonomics, low running costs, high levels of safety, modularity and low environmental impact. This new product wants to meet societies demand for reduced congestions, low road-space occupation and improved intermodality with public transportation systems. In this context, the vehicle is characterized by the following features (fig. 18):



- Very highly efficient propulsion system: the powertrain configurations include full-power fuel cell, plug-in battery electric, battery electric with auxiliary motor-generator (series hybrid), and parallel hybrid with methane fuelled internal combustion engine.
- Compact body and short vehicle length (approx. 3m) with high vehicle habitability.
- Advanced technologies for integrated preventive, active and passive safety, in order to attain the highest levels of Euro-NCAP consumer ratings.
- Latest solutions for human-machine and machine-infrastructure interactions and communication personalized depending on the user and on the specific application.
- This economic and ecological urban vehicle aspires to become an ideal mode of transport for environment-aware individuals and municipal authorities. This dual-use concept (ie. individuals as conventional cars or as a means of personalised public transport) introduces radically new opportunities for vehicle design: a) the development of a platform: chassis and low part of the vehicle can be configured in a highly flexible manner in order to accommodate the different propulsions listed above; b) the design of two vehicle bodies and their relative interiors offering different styles and appropriate technologies.

In MECCANO project several automotive companies are directly involved (FIAT, Michelin, Magneti Marelli, Marangoni, ecc.) in conjunction with research institutes.

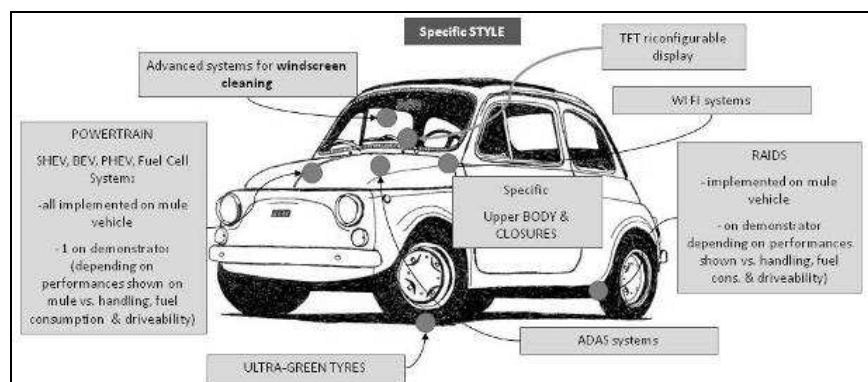

Fig. 18. Meccano project.

The bicycle project “BHYKE” is the study of an innovative electric bicycle in joint venture with an Italian company, called TRE S.p.A. (Tozzi Renewable Energy). The bike, having pedal assistance, is provided with a 250 W fuel cell and a hydrogen solid state storage cylinder of 900 Sl at 12 bar. The targets for this project are: a range of 130-150 km, a maximum speed of 35 km/ h and total weight of 30 kg (fig. 13). The aim of the project is to realize, through a new concept of bike sharing service, a representative sample of field test of hydrogen refuelling station from renewable energy (photovoltaic and wind).

Bike	Technical Characteristic
Max. Power Output	250 W
Max. torque	15 Nm@66 rpm
Motor Voltage range	24V Regulated DC
Hydrogen Storage	Solid State
Hydrogen capacity	900 Sl@12bar
maximum range	150 km@pedal assist.
Total Weight	26 Kg

Fig. 19. Hydrogen bicycle and technical characteristics.

In order to demonstrate that fuel cell technology can be used also in farm sector “Hy-Tractor” project wants to develop a fuel cell tractor fed by hydrogen. In farm sector the hydrogen distribution is not a problem because hydrogen can be produced on site using the available renewable energies: wind, photovoltaic, biomass. The main activities are:

- Development of a hydrogen production and storage system based on: 1) photovoltaic and electrolyzer (fig. 14), 2) biomass, 3) low temperature thermolysis, 4) high temperature pyrolysis;
- Design and development of tractor equipped with fuel cell powertrain, on board hydrogen storage system and other needed auxiliary subsystems.
- Development of energy saving systems for efficiency increase. Some of these are: photovoltaic roof, high efficiency air-conditioning and external lights, hydraulic systems and power take-off (PTO) with electric drive.
- Replacement of hydraulic drive with electric drive, avoiding oil (that is a polluting substances) and increasing the check.
- Design of a *Multi-Power Testing-Trailer* able to carry out simultaneous tests on the traction, hydraulic system and electric devices.
- Field test of the FC tractor during operation both in external sites and inside places (hayloft).

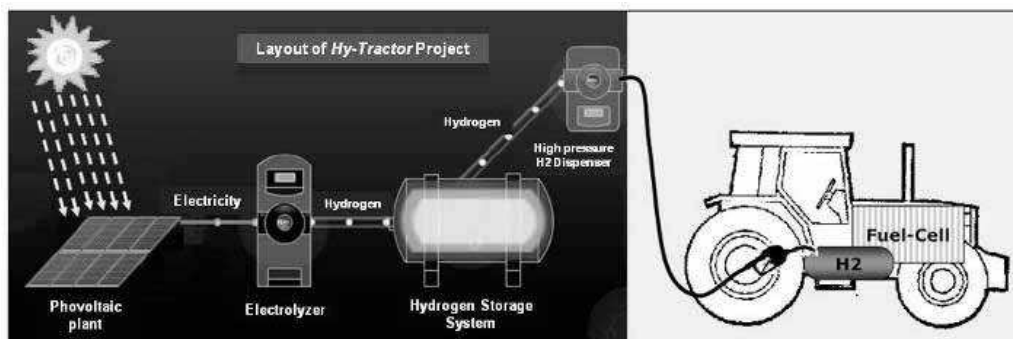

Fig. 20. “Hy-Tractor” : Project layout with photovoltaic plant.

The H-BUS is a joint project of National research Council of Italy and two supplier companies to develop a range extender Fuel Cell/ Battery Hybrid Electric city bus. The aim of H-BUS project is to realize a pre-commercial Fuel Cell/ Battery HEV able to increase the range (at least 30%) with respect to same bus in a standard electric configuration, using a small size of fuel cell that works as batteries recharge on board. Within the project, CNR TAE Institute is involved in determining the optimal level of hybridization assessing all boundary conditions (mission, performances, hydrogen consumption, range, etc...). The bus selected for the prototype realization is an electric vehicle having an 85 kW rated power of electric drive motor and a capacity of 44 passengers (Fig.21).



Fig. 21. The selected bus for the H-BUS project

### 5.1 Fuel cell systems development

The CNR ITAE collaborations with fuel cell developers are focused on improving durability, architecture and cost reduction of fuel cell systems and stacks. As above said, in automotive sector, PEMFC and SOFC are the principal technologies studied. The development of PEM fuel cell systems is summarized in table 5, all devices are fed by pure hydrogen. Gen 3 is a hybrid system composed by a stack of 5 kWe and a battery pack with a power output of 4 kW. Besides, this system is equipped with a new kind of hydrogen recirculation system which increases stack durability up to 10000 hr.

A fuel cell system is composed by fuel cell stack and the linked ancillaries: a blower for the air, a pump for the water and a fan for the cooling circuit (Fig 22). Dedicated micro-computer and software are used for the management of the entire system in terms of operation and safety

The stack is the core component of a fuel cell system but, for the electrical energy production, hydrogen and air have to be fed into the stack. Excess heat must be removed through a cooling system. The operational characteristic curve of a stack (polarization curve) illustrates the device's performance unambiguously. The experimental curve of the fuel cell PEM system is shown in Fig. 23a. It demonstrates that the stack works in a defined range of voltage of 0.65-1V/cell. In this range of voltage it is possible to obtain high performance in terms of efficiency and to limit the materials stress in order to assure a long durability. The figure also reports cell voltage of stack (average voltage of two contiguous cells) at different power levels (fig.23b). The stack is composed by 40 cells.

An important issue in automotive sector is the response time of system. For this reason start-up/ warm-up times have been evaluated at different temperatures in order to determine system limitations and the best operative conditions. The aim was to minimize the battery pack that supply the load and the FC system ancillaries at the same time. The first remark is that batteries cannot be completely eliminated, due to start-up operations. In fact, during the



Rated Power (kW)	5	5	5 kW FC + 4 kW batteries
Number of cells	40	40	40
Temperature (°C)	80	80	80
Active area (cm <sup>2</sup> )	500	500	500
Efficiency (%)	52	54	54
Durability (hr)	1500	3000	10000

Table 5. PEM Fuel Cell Systems development.

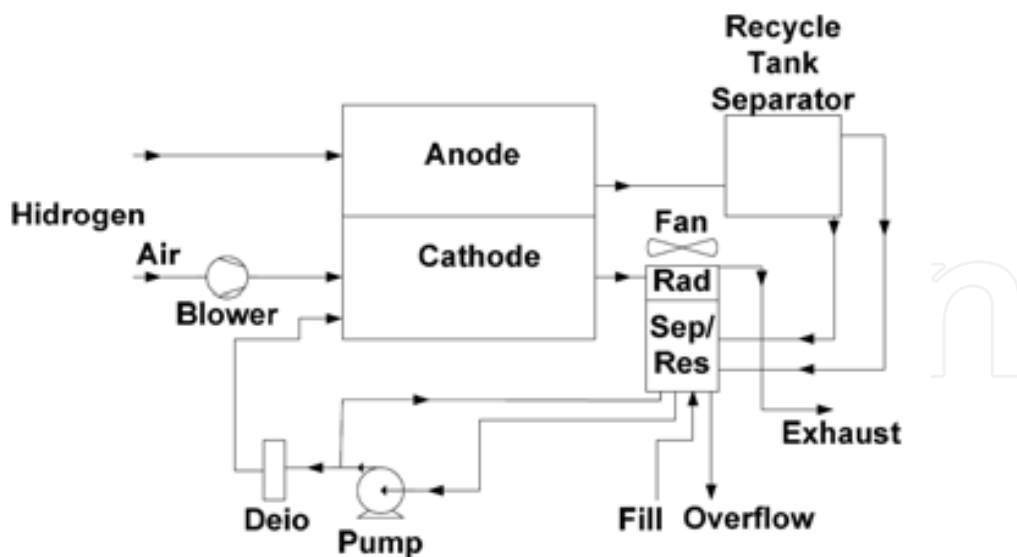

Fig. 22. Schematic diagram of the Fuel Cells System.

start-up, system drains an average current of 13.5 A ( $P = 648W$ ), from an external power supply (Fig. 18). The minimum time needed by the FC system to generate power is ever 7 seconds (FC system software setting), but its value never reaches the maximum value (5 kW) before the warm-up.

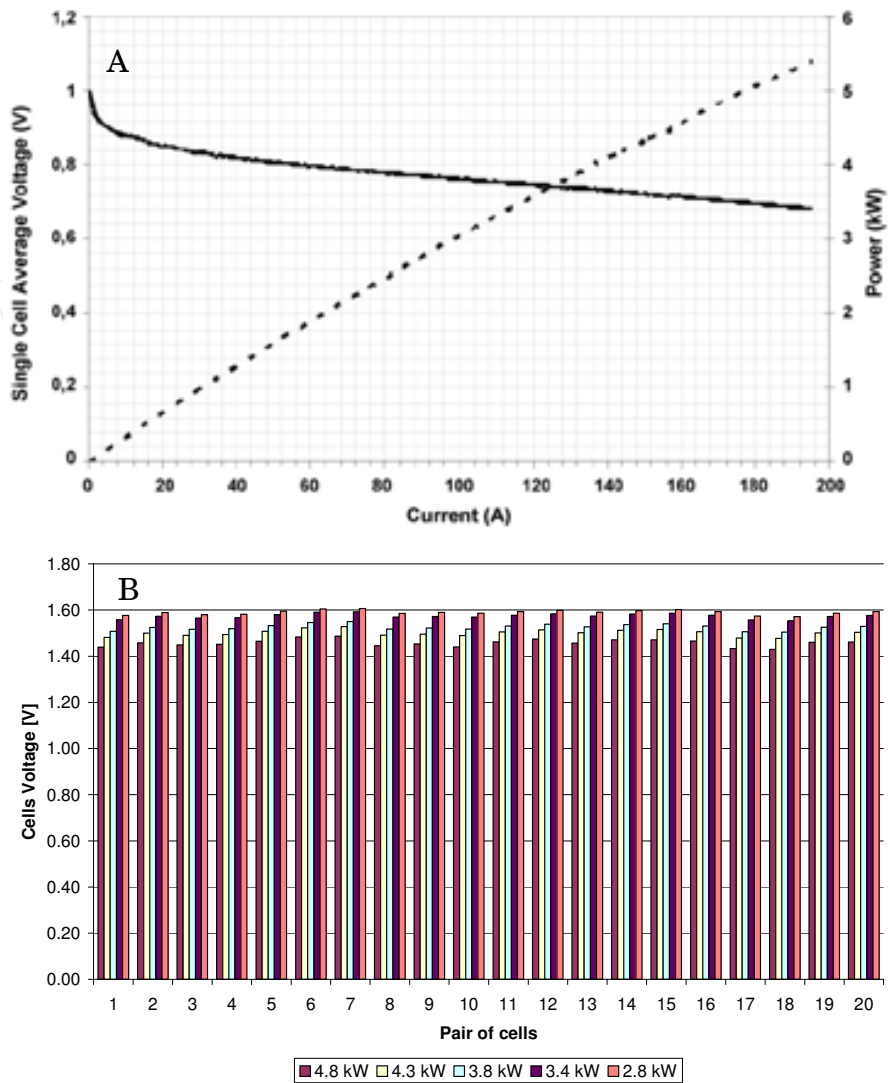

Fig. 23. Polarization curve (A) and voltage distribution (B) for a stack of 40 cells PEM.

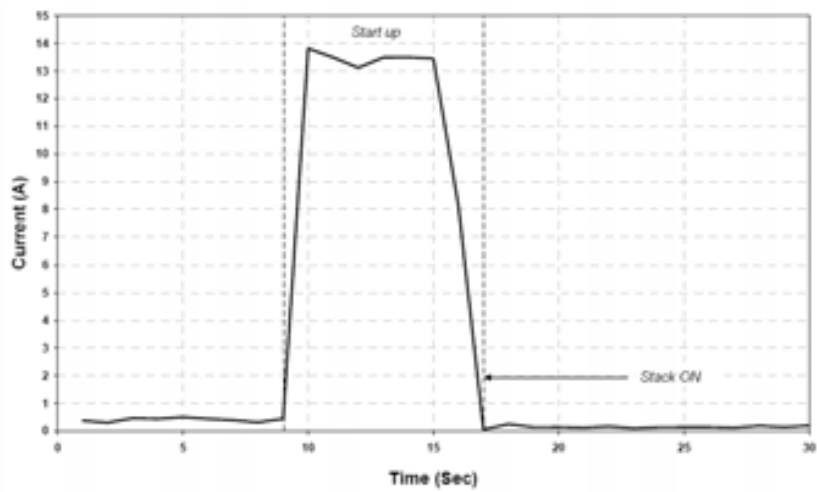

Fig. 24. Current demand from external 48V power supply by FC system during then start-up.

The minimum time needed by the FC system to generate power is ever 7 seconds (FC system software setting), but its value never reaches the maximum value (5 kW) before the warm-up. FC system produces the best response when it starts to run at the nominal temperature as shown in the following figure 19, where is reported the start-up/ warm-up time depending on the different initial FC system temperature. At the nominal temperature, FC system generates maximum power after 76 seconds during start-up routine runs (7 seconds) and FC stack is warmed-up (69 seconds) at the nominal temperature.

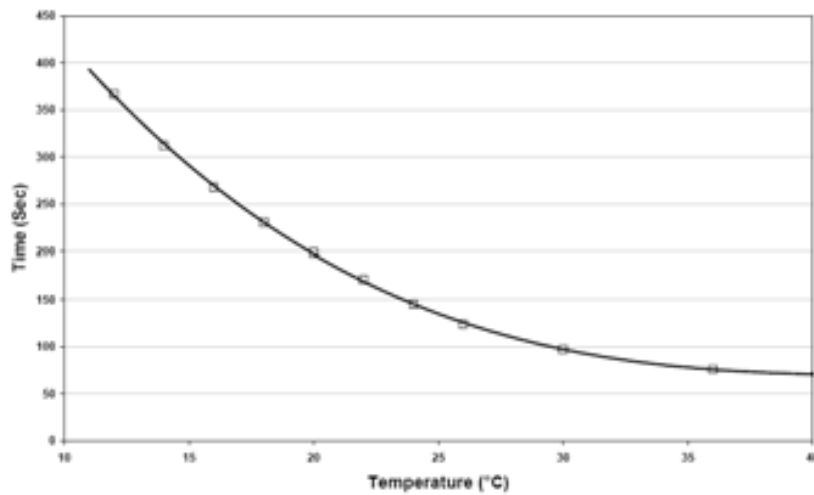
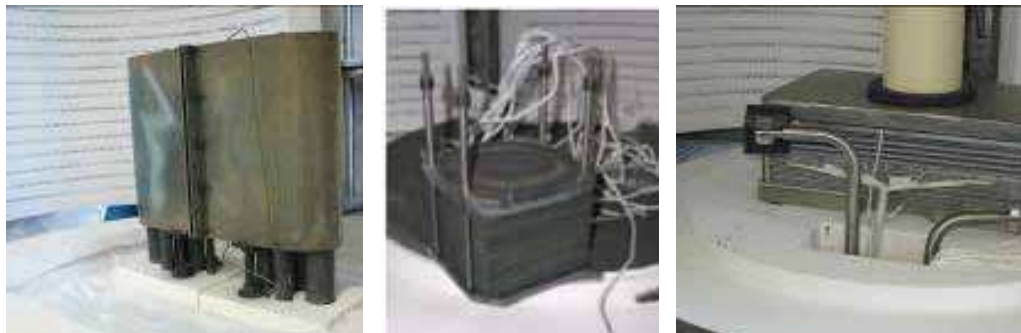

Fig. 25. Start-up times at different initial FC system temperatures.



Rated Power (kW)	1.248	1.811	1.096
Number of cells	75	10	32
Temperature (°C)	650	500	750
Active area (cm <sup>2</sup> )	92	360	50
NG reforming	Internal with pre-reforming	Internal	Internal

Table 6. Features of the three SOFC stacks.

Among Fuel Cells, SOFCs show the great advantage of working with more flexible gas than than polymer electrolyte fuel cells. The table 6 reports the performance of three intermediate

temperature SOFC stacks. The aim is to build a complete SOFC power generation system around the stack. All these three stacks have planar bipolar plate, but they are arranged with different technical solutions: active areas, volumes, dimensions, ect.

A polarization curve of a SOFC system tested is showed in figure 26. The stack power output is 500 W and 55% of electric efficiency is expected. The working temperature is about 750 °C.

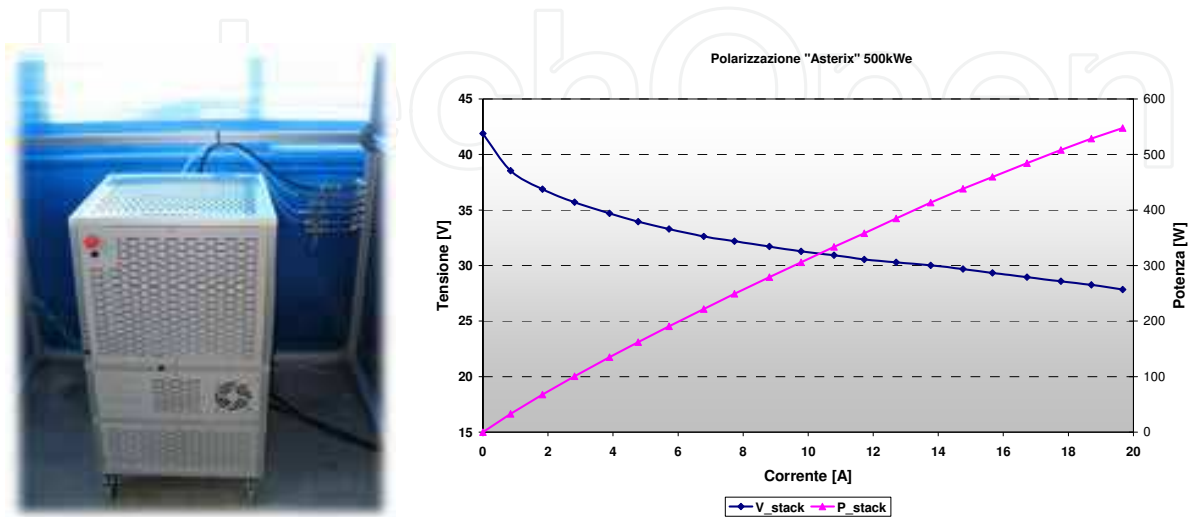

Fig. 26. Polarization curve of a SOFC system with a power of 500 W.

These systems are suitable for small recreation vehicles (i.e. motor cycles, golf car), utility vehicles ( i.e. fork-lift trucks) and hybrid vehicles in range extended configuration.

## 5.2 Hybrid powertrain studies

Over the years, CNR ITAE has evaluated different powertrain configurations in terms of the energy flows and system components size. Here are reported some architectures chosen for hybrid powertrains used in small vehicles and buses.

The structure of a hybrid powertrain for a golf car is the same showed in figure 16. The hybrid powertrain is composed by the following main devices: fuel cell power source, battery pack, static power converter (inserted between FC and load diode between the static power converter and load). The fuel cell system is a compact power module with a nominal power of 5kWe, developed with Nuvera Fuel Cells. The lightweight vehicle was adequately instrumented for data acquisition by applying speed transducer, voltage and current sensors (fig. 27); it was subjected to a work cycle with heavy load conditions, both on road and in laboratory simulated by electric load.

In this latter configuration, the fuel cell is used as main power source for the powertrain, also providing battery charge. The battery has the role to provide peak power during the start up of the vehicle and to supply the necessary energy to the fuel cell system during the start up. The hybrid powertrain has shown a fast response even at extreme and impulsive loads and a wider range compared to a battery vehicle, without compromising the weight limitations on the vehicles.

The figure 28 shows the response of the battery and the fuel cell system during a rising transient. The behaviour of starting batteries is characterized by a short delay in the load response when rising transient begins. This phenomenon is due to a small power inlet from

fuel cell to batteries. The batteries package is connected directly to the electronic load and, in correspondence of the power demand, voltage decreases. As a consequence the recharging current of the batteries increases, since the voltage difference between PowerFlow and batteries is higher than the pre-fixed control value. During this very short time (0.1 s) the fuel cell tries to recharge the batteries even if the demand is higher than its rated power. This delay occurs every time the load changes. Moreover, the load response is slightly lower than the electronic load demand.

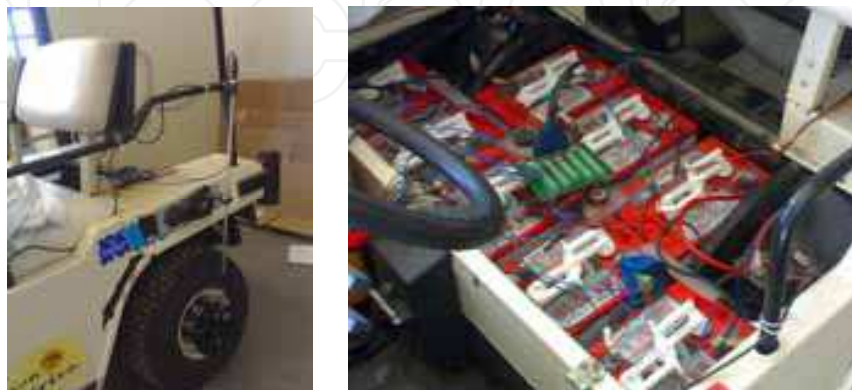

Fig. 27. Golf car Hybrid Powertrain.

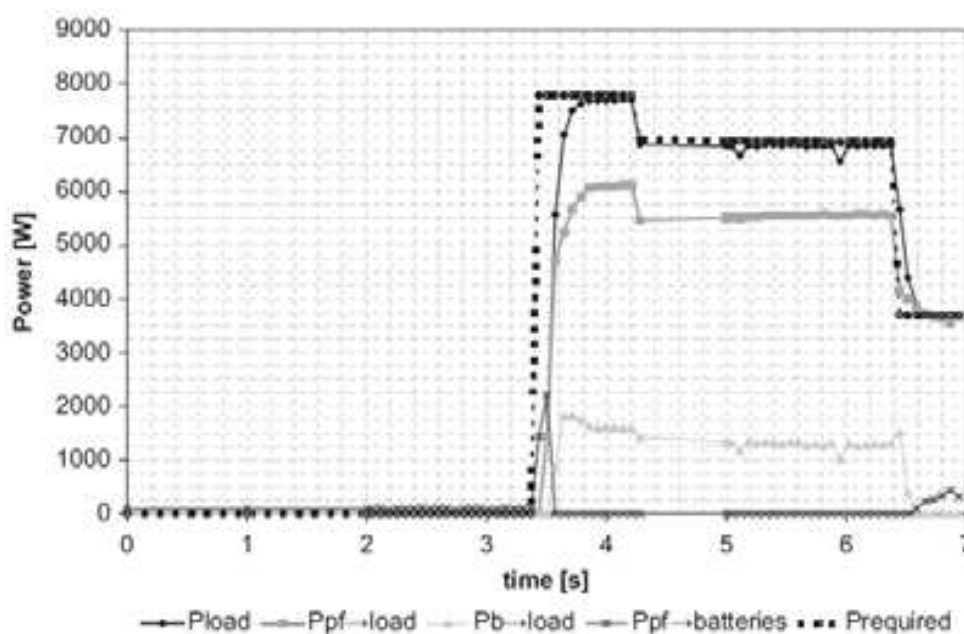

Fig. 28. Response of the battery and the fuel cell system during a rising transient.

An important instrument to identify the most favourable vehicle configuration in specified operating conditions is the computer simulations. Figure 29 shows a power train simulation for a bus in range extended configuration. A range-extender HEV is essentially an EV with an on-board charging system (Suppes GJ et al., 2004). Simulation studies have been performed to evaluate the potential SoC saving and autonomy increase with respect of pure battery EV bus. The simulation models have been developed in the Matlab® Simulink® environment utilizing the SimPowerSystems tool.



In the proposed configuration FC system works as batteries recharge that provides, following an identified strategy, the necessary power to the driving cycle to increase the autonomy of the vehicle. The storage system (traction batteries) provides, however, the energy required to satisfy the peak power demand. PEM Fuel Cell and ZEBRA® (Zero Emission Battery Research Activities) technologies have been selected for the fuel cell system and batteries, respectively.

The study has demonstrated that a power train with 6 ZEBRA® batteries connected with 5 kW FC system appears as the best solution. This configuration allows to increase the range of about 40% as shown Figure 30.

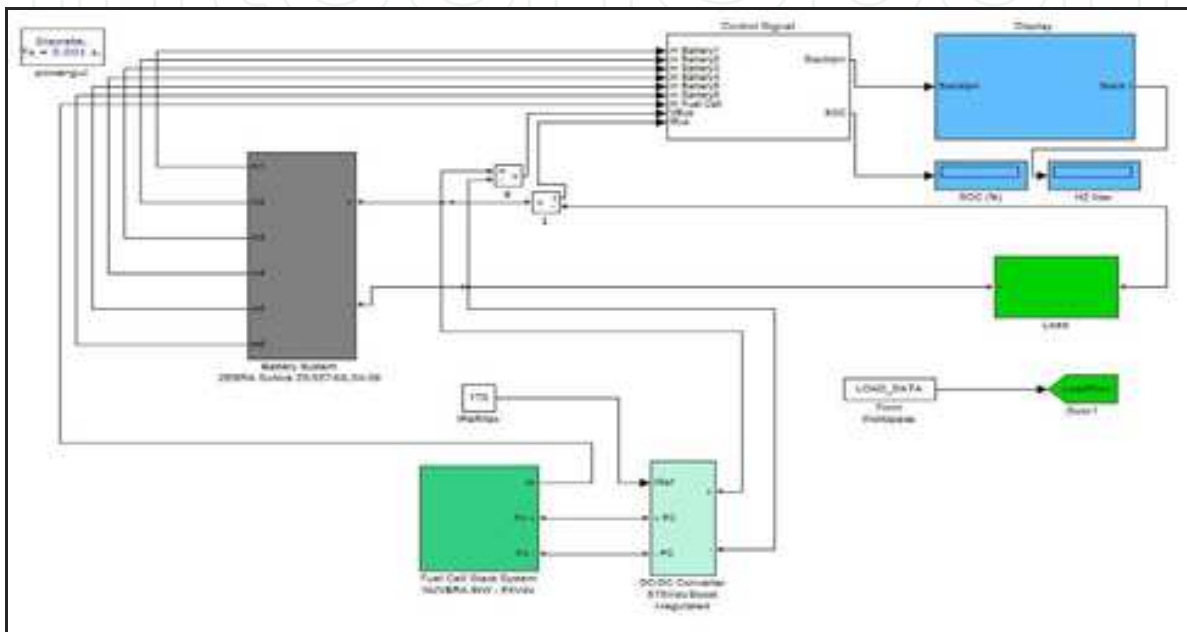

Fig. 29. Simulink® model of the powertrain for bus application.

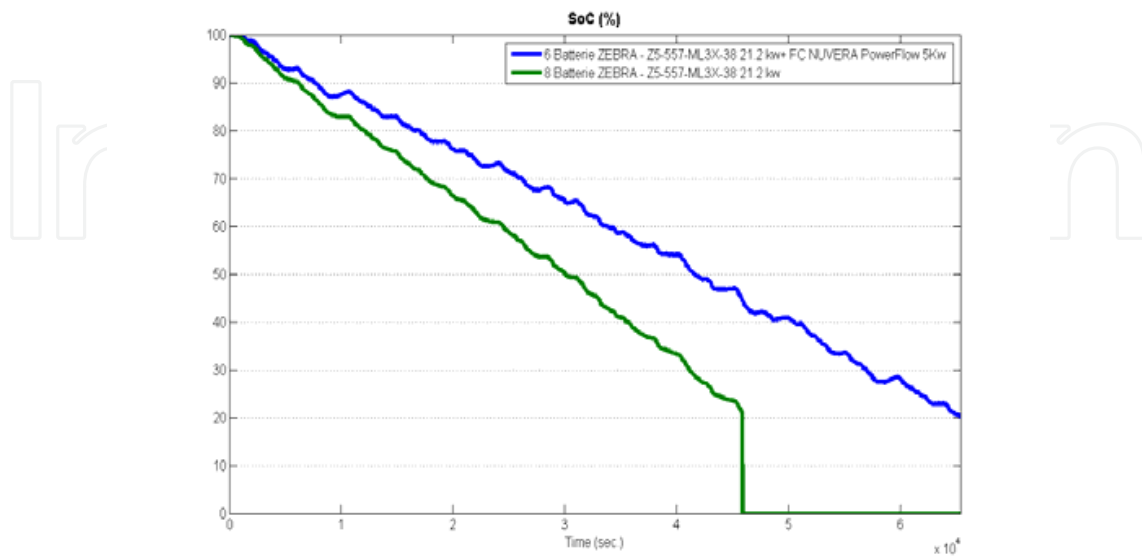

Fig. 30. SoC (%) analysis: Comparison of proposed HEV (blue) and pure battery EV (green).

The obtained results show that Fuel Cells and Batteries achieve an optimal synergy because their combination provides better performance and lower costs than batteries or total fuel cells vehicles.

With regard to the integration of fuel cell in the vehicles, the figure 31 shows the layout bus for the project "H-Bus". The fuel cell system and hydrogen storage are assembled on the top of the vehicle in substitution of N°1 batteries box. In order to reduce costs and improve the fuel cell system technological development the exiting vehicle structure and electric drive train technology have been used.

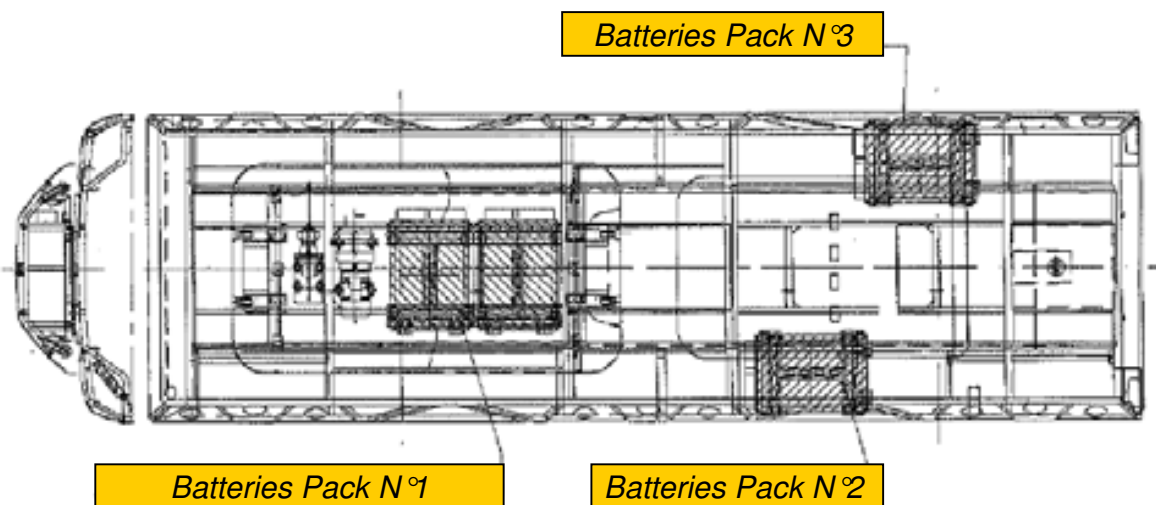

Fig. 31. Position of batteries packs on the top of the electric Bus version (only battery electric vehicle).

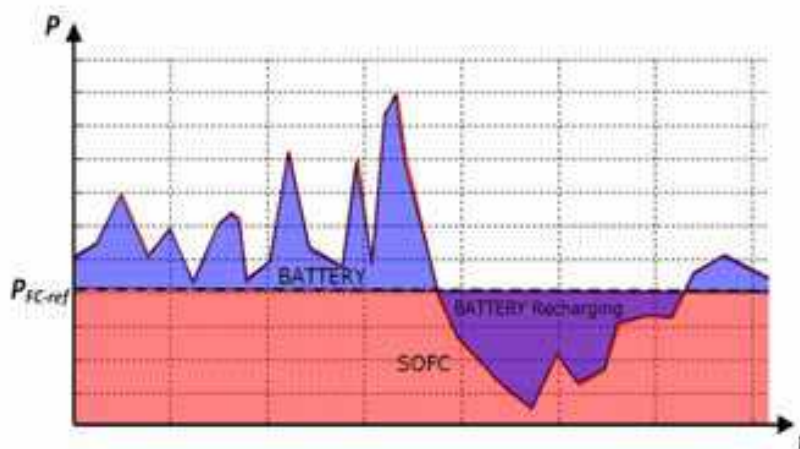

Fig. 32. Example of distribution of the power between SOFC and battery.

Some studies are focused on SOFC technology used mainly for APU demonstration units for road vehicles having a hybrid configuration (Battery and FC). The work here reported regards the integration of a little SOFC system of 500 W with a battery. In particular, a specific control algorithm was developed for utilizing the SOFC system as a *base* power source and battery as a *complementary* source (Fig.32). In fact, on the contrary of PEM technology, SOFC device is not able to follow fast and wide changes of the load because its

high working temperature. The aim is to develop an efficient hybrid system able to deliver the power requirement, to combine energy storage and to ensure durable operation. To obtain benefits from the operation of a hybrid system, the flows of power within the system must be carefully planned and regulated in accordance with an appropriate energetic strategy to optimize the total efficiency and to preserve the devices from stress that may reduce their lifecycle. This research with a power of 500 W can be scaled-up and optimized for specific conditions.

## 6. References

- World Resources Institute, Sustainable Development Information Service, *The global commons: Proceed with caution: Growth in the global motor vehicle fleet*.
- Ogden, J. M. (2005). Alternative fuels and prospects-Overview, In: *Handbook of Fuel Cell*. Wolf Vielstich Arnold Lamm Hubert A. Gasteiger, 3-24, Wiley, England.
- European Commission COM(2010)186 April 2010. A *European strategy on clean and energy efficient vehicles*. Available from: < <http://eur-lex.europa.eu/LexUriServ/LexUriServ.do?uri=COM:2010:0186:FIN:EN:PDF>>.
- McKinsey & Company on behalf of a consortium of 31 public and private companies. (November 2010). *A Portfolio of Powertrains for Europe: A Fact Based Analysis: The role of Battery Electric Vehicles, Plug-in Hybrids and Fuel Cell Electric Vehicles*. Available from :< [www.zeroemissionvehicles.eu](http://www.zeroemissionvehicles.eu) >
- DOE, (January 2009). *Hydrogen and Fuel Cell Activities, Progress, and Plans. Report to Congress*. Available from:  
< [http://www.hydrogen.energy.gov/pdfs/epact\\_report\\_sec811.pdf](http://www.hydrogen.energy.gov/pdfs/epact_report_sec811.pdf) >
- DOE, (2010). *Well-to-Wheels Greenhouse Gas Emissions and Petroleum Use for Mid-Size Light-Duty Vehicles*. Available from:  
< [www.hydrogen.energy.gov/program\\_records.html](http://www.hydrogen.energy.gov/program_records.html) >.
- Lisa Callaghan Jerram. 2008. *2008 Bus Survey*, Available from  
< <http://www.fuelcelltoday.com/> >.
- Gemma Crawley. (March, 2006). *Proton Exchange Membrane (PEM) Fuel Cells*, Available from  
< <http://www.fuelcelltoday.com/> >.
- Gemma Crawley. (August, 2007). *Direct Methanol Fuel Cells (DMFC)*. Available from  
< <http://www.fuelcelltoday.com/> >.
- DOE (2010). *Research and Development of Fuel Cells for Stationary and Transportation*. Available from: < [www.energy.gov/](http://www.energy.gov/) >.
- Lisa Callaghan Jerram (May, 2009). *2009 Light Duty Vehicle Survey*. Available from  
< <http://www.fuelcelltoday.com/> >.
- Dr. Jonathan Butler (2008). *2008 Niche Transport Volume 2*. Available from  
< <http://www.fuelcelltoday.com/> >.
- Gemma Crawley (2007). *Solid Oxide Fuel Cells (SOFC)*. Available from  
< <http://www.fuelcelltoday.com/> >.
- Fuel Cell 2000 (2011). Available from  
< <http://www.fuelcells.org/info/charts/carchart.pdf>>.
- Dr. Jonathan Butler (July 2008). *2008 Niche Transport Survey Vol.1*. Available from  
< <http://www.fuelcelltoday.com/> >
- Suppes GJ, Lopes S, Chiu CW (2004). “*Plug-in fuel cell , hybrids as transition technology to hydrogen infrastructure*”. Int. J Hydrogen Energy Vol. 29, pp. (369-374).

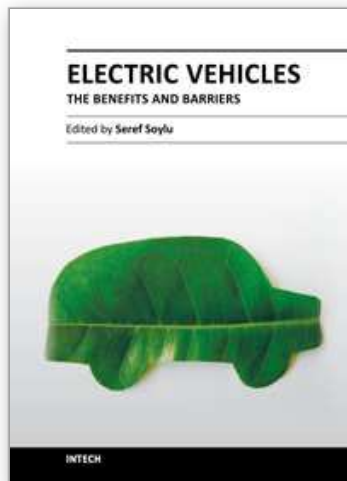

## **Electric Vehicles – The Benefits and Barriers**

Edited by Dr. Seref Soylu

ISBN 978-953-307-287-6

Hard cover, 240 pages

**Publisher** InTech

**Published online** 06, September, 2011

**Published in print edition** September, 2011

In this book, theoretical basis and design guidelines for electric vehicles have been emphasized chapter by chapter with valuable contribution of many researchers who work on both technical and regulatory sides of the field. Multidisciplinary research results from electrical engineering, chemical engineering and mechanical engineering were examined and merged together to make this book a guide for industry, academia and policy maker.

### **How to reference**

In order to correctly reference this scholarly work, feel free to copy and paste the following:

Nicola Briguglio, Laura Andaloro, Marco Ferraro and Vincenzo Antonucci (2011). Fuel Cell Hybrid Electric Vehicles, *Electric Vehicles – The Benefits and Barriers*, Dr. Seref Soylu (Ed.), ISBN: 978-953-307-287-6, InTech, Available from: <http://www.intechopen.com/books/electric-vehicles-the-benefits-and-barriers/fuel-cell-hybrid-electric-vehicles>

**INTECH**  
open science | open minds

### **InTech Europe**

University Campus STeP Ri  
Slavka Krautzeka 83/A  
51000 Rijeka, Croatia  
Phone: +385 (51) 770 447  
Fax: +385 (51) 686 166  
[www.intechopen.com](http://www.intechopen.com)

### **InTech China**

Unit 405, Office Block, Hotel Equatorial Shanghai  
No.65, Yan An Road (West), Shanghai, 200040, China  
中国上海市延安西路65号上海国际贵都大饭店办公楼405单元  
Phone: +86-21-62489820  
Fax: +86-21-62489821

© 2011 The Author(s). Licensee IntechOpen. This chapter is distributed under the terms of the [Creative Commons Attribution-NonCommercial-ShareAlike-3.0 License](https://creativecommons.org/licenses/by-nc-sa/3.0/), which permits use, distribution and reproduction for non-commercial purposes, provided the original is properly cited and derivative works building on this content are distributed under the same license.

IntechOpen

IntechOpen