

# Serpentine Robots for Industrial Inspection and Surveillance

Grzegorz Granosik<sup>1</sup>, Johann Borenstein<sup>2</sup>, Malik G. Hansen<sup>2</sup>

<sup>1</sup> *Technical University of Lodz, POLAND*

<sup>2</sup> *University of Michigan\*, Ann Arbor, MI, USA*



## 1. Introduction

Urban search and rescue, industrial inspections, and military intelligence have one need in common: small-sized mobile robots that can travel across the rubble of a collapsed building, squeeze through small crawl-spaces to take measurements or perform visual inspections, and slither into the shelter of insurgents to gather intelligence. Some of these areas are not only difficult to reach, but may also present safety and health hazards to human inspectors. One species of mobile robots that promises to deliver such hypermobility is the so-called serpentine or snake robot (see Figure 1). Serpentine robots typically comprise of three or more rigid segments that are connected by 2- or 3-degree-of-freedom (DOF) joints. The segments typically have powered wheels, tracks, or legs to propel the vehicle forward, while the joints may be powered or unpowered. Desired capabilities for such a robot are:

- ability to traverse rugged terrain, such as concrete floors cluttered with debris, or unfinished floors such as those found on constructions sites;
- ability to fit through small openings;
- ability to climb up and over tall vertical steps;



**Fig. 1.** The OmniTread Model OT-4 serpentine robot entering an "Inverted-'J'" ventilation duct at SwRI<sup>†</sup>.

---

\* The OmniTread work was conducted at the University of Michigan where Dr. Granosik co-developed the "Omni's" as a Visiting Researcher from 2002-2004.

<sup>†</sup> The OmniTread robots were independently tested at the Southwest Research Institute (SwRI). Most of the OmniTread photographs in this chapter were taken at SwRI during the successful traverse of the shown obstacle.

- ability to travel inside and outside of horizontal, vertical, or diagonal pipes such as electric conduits or water pipes;
- ability to climb up and down stairs;
- ability to pass across wide gaps.

This chapter begins with an extended literature review on serpentine robots in general, and then focuses on the concept and features of the OmniTread family of serpentine robots, which were designed and built at the University of Michigan's (UM's) Mobile Robotics Lab. Along the way, we discuss the evolution of OmniTread robots (or "Omnis" in short), showing inheritance of valuable features, mutation of others, and elimination of disadvantageous designs. In the Experiment Results Section, photographs of successful obstacle traverses illustrate the abilities of the Omnis. The chapter concludes with our prognosis for future work in this area.

## 2. Serpentine Robots

Serpentine robots belong to the group of hyper-redundant articulated mobile robots. This group can be further divided based on two characteristic features: the way the forward motion of the robot is generated and the activity of its joints, as shown in Table 1. As our work is focused on serpentine robots we will limit the following literature review to this scope.

The first practical realization of a serpentine robot, called KR-I, was introduced by Hirose and Morishima (1990) and later improved with version KR-II (Hirose et al., 1991). This first serpentine robot was large and heavy, weighing in at 350 kg. The robot comprised of multiple vertical cylindrical segments on powered wheels (tracks in KR-I) that give the mechanism a train-like appearance. Vertical joint actuators allow a segment to lift its neighbors up, in order to negotiate steps or span gaps.

More recently, Klaassen and Paap (1999) at the GMD developed the Snake2 vehicle, which contains six active segments and a head. Each round segment has an array of 12 electrically driven wheels evenly spaced around its periphery. These wheels provide propulsion regardless of the vehicle's roll angle. Segments are interconnected by universal joints actuated by three additional electric motors through strings. Snake2 is an example of a robot that is inspired by the physiological structure of snakes where wheels replace tiny scales observed on the bodies of some real snakes. Snake2 is equipped with six infrared distance sensors, three torque sensors, one tilt sensor, two angle sensors in every segment, and a video camera in the head segment. Snake2 was specifically designed for the inspection of sewage pipes.

Another serpentine robot designed for sewer inspection was developed by Scholl et al. (2000) at the Forschungszentrum Informatik (FZI) in Germany. Its segments use only two wheels but the actuated 3-DOF joints allow full control over each segment's spatial orientation. The robot is able to negotiate tight 90° angled pipes and climb over 55 cm high obstacles. One segment and its joint are about 20 cm long. The sensor suite of this robot is similar to that of Snake2. The development of sewer inspection robots is continued in the joint project MAKROplus (Streich & Adria, 2004).

While wheeled serpentine robots can work well in smooth-walled pipes, more rugged terrain requires tracked propulsion. To this effect Takayama and Hirose

**Table 1.** Articulated mobile robots.

	External propulsion element: legs, wheels, tracks	Movement is generated by undulation
Active joints	<p>Serpentine robots:</p>  <p>OmniTread</p>  <p>Moira</p>  <p>Kohga</p>  <p>Soryu</p>  <p>Snake 2 Robot</p>  <p>MAKROplus Robot</p>  <p>Pipeline Explorer</p>	<p>Snake-like robots:</p>  <p>ACM (Hirose, 1993)</p>  <p>ACM-R3 (Mori &amp; Hirose, 2002)</p>  <p>Slim Slime Robot (Ohno &amp; Hirose, 2000)</p>
Passive joints	<p>Active wheels – passive joints robots:</p>  <p>Genbu 3 (Kimura &amp; Hirose, 2002)</p>	

(2000) developed the Soruyu-I crawler, which consists of three segments. Each segment is driven by a pair of tracks, which, in turn, are all powered simultaneously by a single motor, located in the center segment. Torque is provided to the two distal segments through a rotary shaft and universal joints. Each distal segment is connected to the center segment by a special 2-DOF joint mechanism, which is actuated by two lead screws driven by two electric motors. The robot can move forward and backward, and it can change the orientation of the two distal segments in yaw and pitch symmetrically to the center segment. One interesting feature is the ability of this robot to adapt to irregular terrain because of the elasticity of its joints. This elasticity is provided by springs and cannot be actively controlled.

A different concept using unpowered joints was introduced by Kimura and Hirose (2002) at the Tokyo Institute of Technology. That robot, called Genbu, is probably the only serpentine robot with unpowered joints. The stability of the robot and its high mobility on rough terrain are preserved by large-diameter wheels (220 mm). The control system employs position and torque feedback sensors for the passive but rigid joints. Springs are used to protect the electric motors from impact, although the stiffness of the springs cannot be controlled during operation.

Another robot incorporating a combination of passive and active joints as well as independently driven and coupled segments is KOHGA developed by Kamegawa et al. (2004). This robot implements a smart design feature: besides a camera in the front segment, there is a second camera in the tail section that can be pointed forward, in the way a scorpion points its tail forward and over-head. This “tail-view” greatly helps teleoperating the robot.

The concept of joining several small robots into a train to overcome larger obstacles was used by researchers from Carnegie Mellon University in their Millibot Train (Brown et al., 2002). This robot consists of seven electrically driven, very compact segments. The diameter of the track sprockets is larger than the height of each segment, which allows the robot to drive upside-down. Segments are connected by couplers for active connection and disconnection, but the joints have only one DOF. Each joint is actuated by an electric motor with a high-ratio harmonic gear and slip clutch. It provides sufficient torque to lift up the three front segments. The robot has been demonstrated to climb up a regular staircase and even higher steps. However, with only one DOF in each joint the vehicle is kinematically limited.

A serpentine robot that uses tracks for propulsion and pneumatics for joint actuation is MOIRA (Osuka & Kitajima, 2003). MOIRA comprises four segments, and each segment has two longitudinal tracks on each of its four sides, for a total of eight tracks per segment. The 2-DOF joints between segments are actuated by pneumatic cylinders. We believe that the bellows-based joint actuators used in our OmniTread have a substantial advantage over a cylinder-based design, as the discussion of our approach in the next section will show.

The newest construction from NREC (National Robotics Engineering Center) is Pipeline Explorer - robot designed and built for inspection of live gas pipelines (Schempf et al., 2003). This robot has a symmetric architecture. A seven-element articulated body design houses a mirror-image arrangement of locomotor (camera) modules, battery carrying modules, and support modules, with a computing and electronics module in the middle. The robot’s computer and electronics are protected in purged and pressurized housings. Segments are connected with articulated joints: the locomotor modules are connected to their neighbors with pitch-roll joints, while the others - via pitch-only joints. These specially designed joints allow orientation of the robot within the pipe, in any direction needed.

The locomotor module houses a mini fish-eye camera, along with its lens and lighting elements. The camera has a 190-degree field of view and provides high-resolution color images of the pipe’s interior. The locomotor module also houses dual drive actuators designed to allow for the deployment and retraction of three legs equipped with custom-molded driving wheels. The robot can sustain speeds of up to

four inches per second. It is fully untethered (battery-powered, wirelessly controlled) and can be used in explosive underground natural gas distribution pipelines.

### 3. The Omnis Family

#### 3.1 Robots Description

Since 1998 the Mobile Robotics Lab at the University of Michigan (UM) has focused on the development of serpentine robots. Figure 2 shows our first serpentine robot, the OmniPede (Long et al., 2002). Although we conceived of the idea for the OmniPede independently, we later found that nature had produced a similar design: the millipede (see Figure 3a). In the OmniPede, UM introduced three innovative functional elements: (1) propulsion elements (here: legs) evenly located around the perimeter of each segment; (2) pneumatic power for joint actuation; and (3) a single so-called “drive shaft spine” that transfers mechanical power to all segments from a single drive motor.



Fig. 2. OmniPede.

One of the key features in the design of the OmniPede is that each leg has only one degree of freedom (DOF). A “leg” and its associated “foot” look like the cross section of an umbrella. The trajectory of the foot and the orientation of the leg are determined by a simple mechanism as shown in Figure 3b. The geared 5-bar mechanism moves the leg so that the foot makes contact with the terrain while performing the backward portion of its motion (which is the portion that propels the vehicle forward). Then the foot disengages from the terrain while it performs the forward portion of its motion (as shown in Figure 3c). As a result the OmniPede moves forward.

By having only one DOF per leg instead of the two or three DOF that most other legged vehicles have, the number of required actuators is reduced. The price that is paid for the reduced complexity, weight, and cost is having less control over the position and orientation of the legs. However, we considered this to be a small sacrifice because with the OmniPede precise leg positioning is unimportant. Also, the reduced complexity of the legs offers further advantages, as described below.

The OmniPede consists of seven identical segments, with the tail segment housing the motor. Each segment has four of the legs shown in Figure 3b arranged circularly on its circumference and evenly spaced at 90-degree intervals. The legs are arranged this way so that no matter which part of the OmniPede is in physical contact with the environment, contact is always made through some of the feet. The segments are connected through articulated joints, which allow two DOF between the segments. These two DOF are each independently controlled with a pneumatic piston by means of a four-bar mechanism. This feature provides the OmniPede with the versatility that was lost by linking the legs kinematically. The joint actuators enable the OmniPede to lift its front end up and onto obstacles much the same way a millipede (or a worm or a snake) do. Another key feature of the OmniPede design is that the motion of each leg is kinematically linked to a common drive shaft, called the drive



shaft spine, that runs through the centre of the vehicle. This allows all of the legs to be driven by just one actuator, which supplies torque to the common drive shaft. Also, because the legs are all kinematically linked by the common drive shaft, the phase differences between all of the legs are fixed.

Unfortunately, the OmniPede never reached the mobility level of millipedes. Partially because of the scale factor (our robot is much larger than its natural counterpart) and mainly because we could not produce the same foot density (number of feet per side area of robot) as nature did. Therefore, our design needed modifications; we could say it was real evolution. We abandoned the idea of few discrete legs altogether, and instead adopted the abstract idea of a continuous, dense “stream of legs;” we noticed that trace of each foot can be seen as track, as schematically shown in Fig. 3. Using tracks (executing rotation) we improved efficiency of driving mechanism. We also improved design of robot’s joints by introducing Integrated Joint Actuator (described in detail later). And finally, we preserved the idea of “drive shaft spine” with a single drive motor.

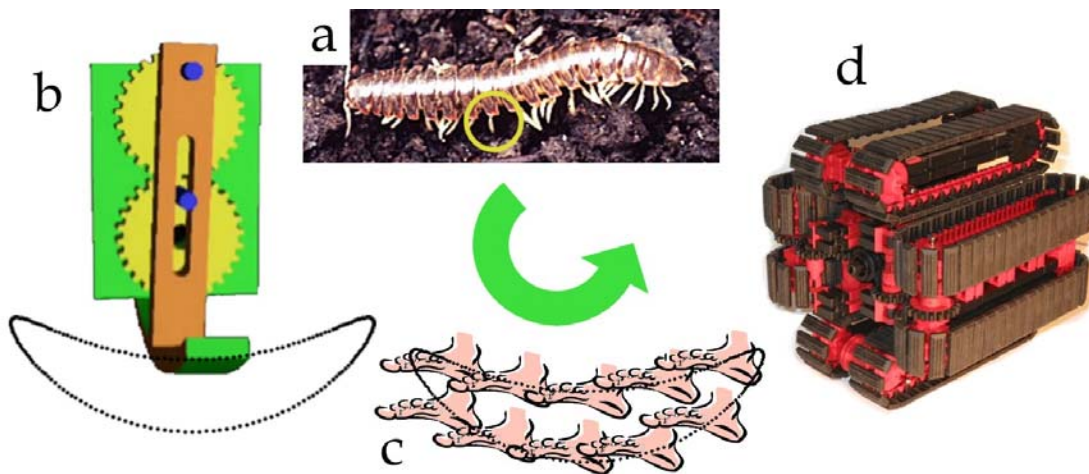
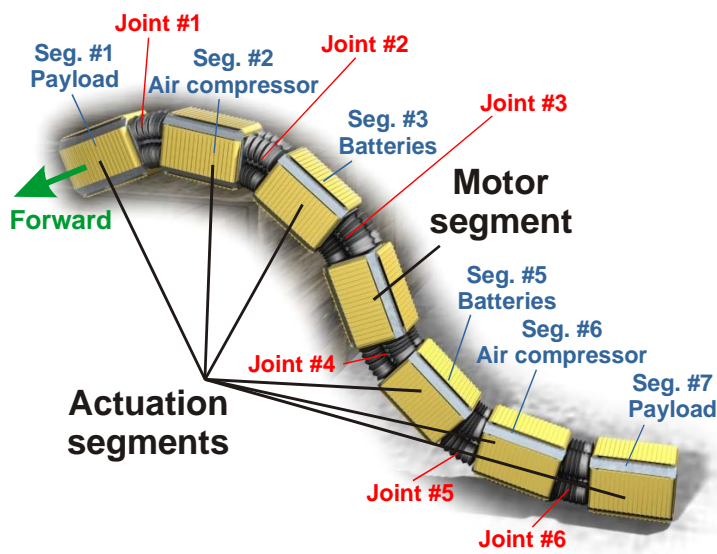

**Fig. 3.** Evolution of driving system: from the legged OmniPede to the tracked OmniTread. a - millipede, b - 1DOF leg of the OmniPede, c - propulsion idea of OmniPede’s foot, d - Proof-of-concept prototype of the OmniTread: In an abstract sense, a moving track with grousers can be seen as a continuous stream of moving legs.

From the study of the OmniPede, and from the observed shortcomings of its legged propulsion system, we derived important insights about the design of serpentine robots. These insights led to the development of the far more practical “OmniTread” serpentine robot, shown in Table 1. This version of the OmniTread, later called “OT-8,” has five segments and four pneumatically actuated 2-DOF joints. The size of each segment is 20×18.6×18.6 cm (length × width × height). Each joint space is 6.8 cm long. The entire robot is 127 cm long and weighs about 13.6 kg. The OmniTread is teleoperated and has off-board power sources (electric and pneumatic).

In May 2004 we began work on the latest and current version of the OmniTread, the OT-4. The number designation comes from its dominant design parameter: the OT-4 can fit through a hole 4 inches (10 cm) in diameter, whereas the OT-8 can fit through an 8-inch diameter hole.

The OmniTread OT-4 comprises seven segments and six 2-DOF joints, as shown in Figure 4. The segment in the centre is called “Motor Segment” because it houses the single drive motor. All other segments are called “Actuation Segments” because they house, among others, the control components for the pneumatic actuators. Segments #1 and #7 are able to hold some payload, such as cameras, microphones, and speakers. Segments #2 and



**Fig. 4.** Nomenclature for segments and joints of OmniTread OT-4.

#6 can hold one micro air-compressor each, for pneumatic power. Segments #3 and #5 hold Li-Polymer batteries. The OT-4 can carry onboard energy resources for up to 75 minutes of continuous, untethered driving on easy terrain.

The OT-8 and OT-4 share these mostly unique features:

1. Tracks-all-around each segment. This design aims at maximizing the coverage of the whole robot body with moving tracks. This feature is tremendously important on rugged terrain since the long, slender body of serpentine robots rolls over easily on such terrain. The disadvantage of this design is the greater complexity (each segment needs four drive systems) and the space needed for four drive systems.
2. The 2-DOF joints are actuated by pneumatic bellows, which produce sufficient torque to lift the three (two in case of OT-8) leading or trailing segments up and over obstacles. More importantly, pneumatic bellows provide natural compliance with the terrain. This feature assures optimal traction in bent pipes and on rugged terrain.
3. A single electric drive/motor in the center segment provides rotary power to each segment through a so called “drive shaft spine” that runs through the whole length of the robot. We believe this design to be more weight and power efficient than individual motors in each segment. The weaknesses of this design are a limit to the maximal bending angle of the joints of  $\sim 40$  degrees, as well as inefficiency when articulating the joints.

### 3.2 Tracks All Around

Our doctrine in the design of both OmniTread models is the maximal coverage of all sides of the robot with moving tracks. This doctrine is based on two reasons:

1. Serpentine robots inevitable roll over when traveling over rugged terrain. Since terrain conditions may not allow the robot to upright itself immediately, only



**Fig. 5.** Tracks all around: As the OmniTreads drive through rockbeds, it becomes apparent that side tracks help provide forward propulsion. a – OT-8; b – OT-4.

coverage of all sides with propulsion elements can assure continuation of the mission after a roll over.

- Any contact between an environmental feature and a robot's inert (i.e., not propelling) surface impedes motion or entirely stops the robot (i.e., the robot gets "stuck"). In contrast, any contact between an environmental feature and a propulsion surface produces motion. On rugged terrain, such as the rubble of a collapsed building, it is quite common that not just the bottom side of the robot, but also its left and right side make contact with terrain features.

To express this relation quantitatively, we define the term "Propulsion Ratio"  $P_r$ .  $P_r$  is measured as the surface area that provides propulsion,  $A_p$ , divided by the total surface area,  $A_p + A_i$

$$P_r = A_p / (A_p + A_i) \quad (1)$$

where  $A_i$  is the inert surface area of the body. To further clarify,  $A_p$  is the sum of all surface areas that could provide propulsion if in contact with the environment, while  $A_i$  is the sum of all surface areas that could not.  $P_r$  is not only a function of the robot's geometry, but also of the application domain. For example, on flat and hard terrain,  $P_r$  for a conventional automobile is 1.0 since only the wheels can be in contact with the terrain. That's because in a car no inert area of the periphery could possibly be in contact with the ground, that is,  $A_i = 0$ . However, on soft terrain the wheels sink into the ground and on rugged terrain obstacles protrude out of the ground, resulting in potential contact between the ground and portions of the inert body periphery. In this case the propulsion ratio  $P_r$  is undesirably low. In practice, serpentine robots with a low propulsion ratio get stuck very easily when trying to move over rugged terrain. In order to increase the propulsion area  $A_p$  and thus the propulsion ratio  $P_r$ , we cover all sides of the OmniTread with extra-wide tracks (as is also advised by Blich, 2003). We also took extensive measures to reduce the space (and thus, the inert area  $A_i$ ) between the segments. Environments, in which robots with high propulsion ratios excel, are dense underbrush, rubble, and rocks (see Fig. 5). In these environments contact can occur anywhere, and robots that have propulsion surfaces only on the bottom are always at risk of being stalled due to excessive, nonpropelling contact. The propulsion ratio for the OT-4 is 0.59 while that of our earlier OmniTread OT-8 is 0.42. ¶



### 3.3 Pneumatic Joint Actuation

During our work with serpentine robots, we spent a significant amount of time on the analysis and formulation of requirements for joint actuators in serpentine robots. Listed here are the four most important ones:

1. By definition, serpentine robots are relatively long compared to their diameter, so that their lead segments can reach up and over a high obstacle while still being able to fit through small openings, as shown in Fig. 6. However, lifting the lead segments requires a significant amount of torque, which is particularly difficult to generate in slender serpentine robots, where the lever arm for a longitudinal lifting force is limited by the robot's small diameter. One key requirement for serpentine robots is thus that they employ joint actuators of sufficient strength to lift up two or more of their lead or tail segments.
2. Another key requirement is that serpentine robots should conform to the terrain compliantly. This assures that as many driving segments as possible are in contact with the ground at all times, thereby providing effective propulsion. Serpentine robots that don't conform compliantly require extremely complex sensor systems to measure contact forces and to command a momentary angle for each non-compliant joint so as to force contact with the ground. Such actively controlled compliance has not yet been successfully demonstrated, and may well be unfeasible for many more years.
3. At times it is necessary to increase the stiffness of a joint, for example to reach over an obstacle, or for crossing a gap (see Fig. 7). Alternatively, it may be necessary to adjust the stiffness to an intermediate level, for example, when the lead segment leans against a vertical wall while being pushed up that wall by the following segments. Thus, serpentine robots should be capable of adjusting the stiffness of every DOF individually and proportionally.

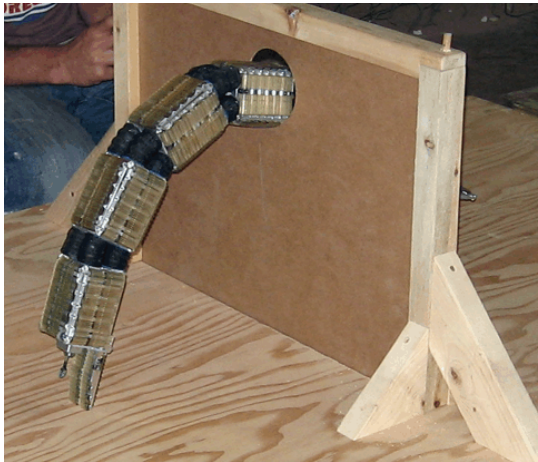

**Fig. 6.** OT-4 passes through a 10-cm (4") diameter hole, high above ground. Extendable "flipper tracks" in the distal segments allows the robot to straddle the hole without having to support its weight on the sharp edges of the hole in this test at SwRI.

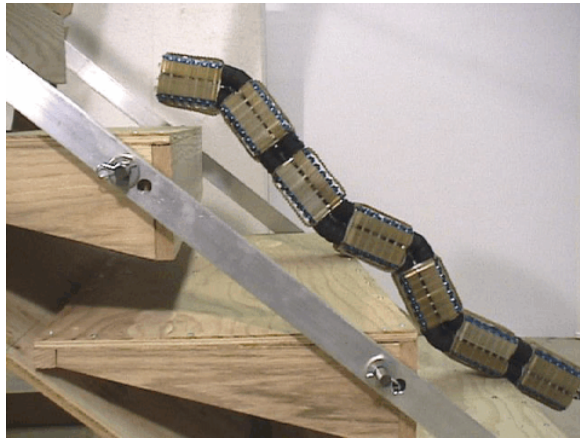
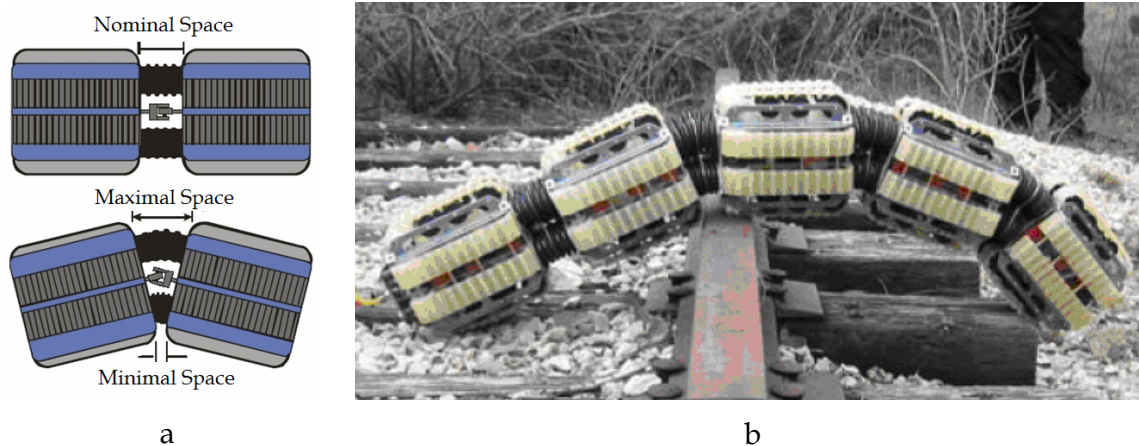

**Fig. 7.** Joint strength and stiffness: OT-4 lifting up three lead segments in order to reach the next step.

4. Large amounts of space dedicated to joints dramatically increase the amount of inert surface area. Therefore, joint actuators should take up as little space as possible, to reduce the size of space occupied by joints (called “Joint Space”).

Moreover, it is obvious that the weight of the actuators should be minimal and joint angles in serpentine robots should be controllable proportionally, to provide full 3D mobility. Extensive studies of these requirements and of joint actuators potentially meeting these requirements led to the second unique design feature of the OmniTread, the use of pneumatic bellows for actuating the joints. Our research (Granosik & Borenstein, 2005) shows that pneumatic bellows meet all four of the above requirements better than any other type of actuator. In particular, pneumatic bellows provide a tremendous force-to-weight ratio, and they fit perfectly into the otherwise unusable (since varying) space between segments.

The latter point is illustrated in Figure 8a, which shows that parts of Joint Space may be small at one moment, and large at the next, depending on the bending of the joint. If we wanted to use Joint Space for housing electronics or other rigid components, then the size of that component would be limited by the dimensions of the “minimal space” shown in Figure 8a. Contrary to rigid components, pneumatic bellows fit into such varying spaces perfectly: bellows expand and contract as part of their intended function, and they happen to be smallest when the available space is minimal and largest when the available space is maximal. From the point of space utilization, pneumatic bellows are thus a superbly elegant solution, because joint actuators take up only Joint Space, and very little of it, for that matter. Therefore, we call our bellows-based pneumatic system “Integrated Joint Actuator” (IJA). In contrast,



**Fig. 8.** Integrated Joint Actuator: a – In serpentine robots the shape of the so-called “Joint Space” varies with the angles of the joint. At extreme angles, there are some regions of Joint Space where there is almost no free space for mounting rigid components. However, the bellows of the OmniTreads conform to the available space. b – In the OT-8, Joint Space is only 6.8 cm long while segments are 20 cm long. This design helps produce a very favorable Propulsion Ratio  $P_r$ . The obvious advantage is the OmniTread’s ability to rest its weight on some obstacle, such as this railroad rail, without getting its Joint Space stuck on it. The sharp edge of the hole in Fig. 6, however, was meant to penetrate joint space, as an additional challenge.

pneumatic cylinders or McKibben muscles, as well as electric or hydraulic actuators, would all require space within the volume of the segments or much larger Joint Space. To further illustrate our point about small versus large Joint Spaces, we included Figure 8b, which shows how the OT-8 successfully traverses a relatively narrow-edged obstacle, thanks to its very short joints. If the joints were longer than the rail's width, then the robot would necessarily get stuck on it.

### 3.4 Motor and Gear Train

In case of OmniTread OT-8 a single 70W drive motor (Model RE36 made by Maxon) located in the central segment provides torque to all tracks on all five segments via the drive shaft spine. The drive shaft spine is an axle that runs longitudinally through all segments. Universal joints let the axle transfer torque at joint angles of up to  $30^\circ$ . Within each segment there is a worm on each driveshaft that drives four worm-gears offset  $90^\circ$  from each other, as shown in Figure 9a. Each worm gear runs two spur gears ending in chain drives to deliver power to the sprocket shafts. The purpose of the spur gears is to bring the chain back to center again so that the two tracks on each side can be of equal width. The chain drive is very slim and therefore minimizes the gap between the tracks. The total gear reduction from the motor to the sprockets is 448:1. The drive system and chain drive is sealed to prevent dirt from entering the mechanism.

A similar drive train mechanism was developed for the OT-4. The drive shaft spine comprises seven rigid shafts that are connected by six universal joints. The universal joints are concentrically located within the gimbal joints that link the segments. On

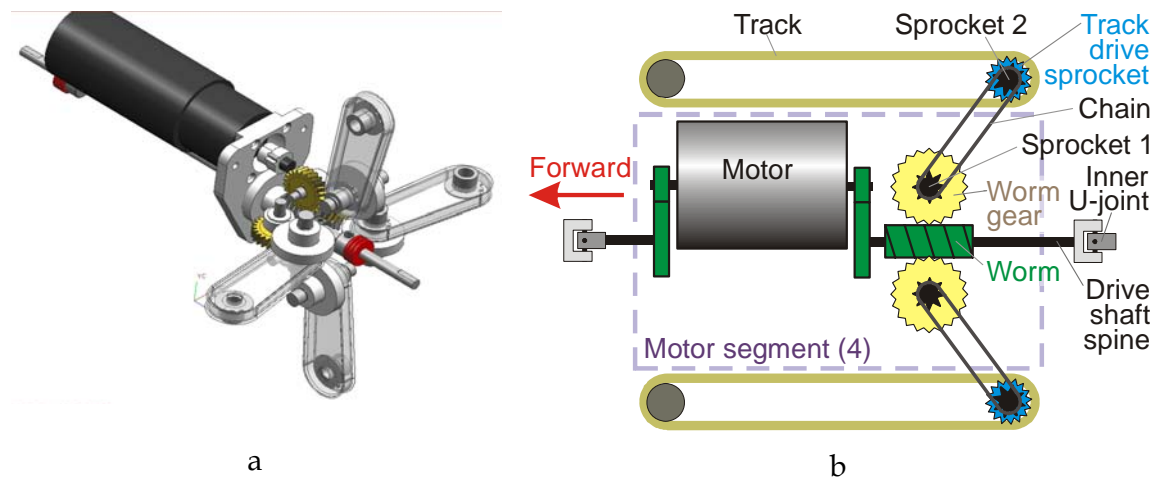

**Fig. 9.** CAD drawings of the OmniTread gearboxes: a - OT-8 gearbox, shown here for the motor segment. b - Schematic of the OT-4 drive system, shown here for the motor segment. c - CAD drawing of the OT-4 motor segment.

each shaft segment is a worm. Four worm gears feed off that worm on the drive shaft as shown in Figure 9b. Each worm gear drives a chain that drives the track sprocket. These worm gears can be engaged with worm or disengages from it by means of electrically actuated bi-stable clutches. The OT-4 has one such a clutch for each of its  $7 \times 4 = 28$  tracks. These clutches allow the operator to engage or disengage each track individually. Thus, tracks not in contact with the environment can be disengaged to reduce drag and waste of energy. If the robot rolls over, the tracks that come into contact with the ground can be reengaged by the operator.

The drive shaft is supported by two ball bearings on each end of the gearbox to retain good tolerances within the gearbox. The other end of the drive shaft is floating and only supported by the universal joint. Not constraining the shaft at three points prevents the driveshaft from flexing too much, if the structure of the segment warps under high loads. The motor has too large a diameter to fit into the segment next to the drive shaft spine (see Figure 9c), as is the case in the OT-8. However, the OT-4 drive motor has two output shafts, so that each drives one half of the now split drive shaft spine.

#### 4. Design Details OT-8 vs. OT-4

In this section we provide details on some the more important components of the OmniTreads. We also compare design features of the OT-8 with those of the newer and more feature-rich OT-4

##### 4.1 Tracks

The OT-8 has 40 tracks and 160 sprockets and rollers. These components make up a significant portion of the overall weight of the system. In order to minimize system weight, we sought tracks that were particularly lightweight. In addition, the tracks had to offer low drag and they had to be able to accommodate debris (especially sand) that could get trapped between the tracks and the drive sprockets.

A solution was found in the form of a slightly elastic urethane material that would stretch to accommodate debris without mechanical tensioners, yet was strong enough not to slip over the sprocket teeth under stress. After testing different tracks designs we selected the section profile shown in Figure 10a. This design is an

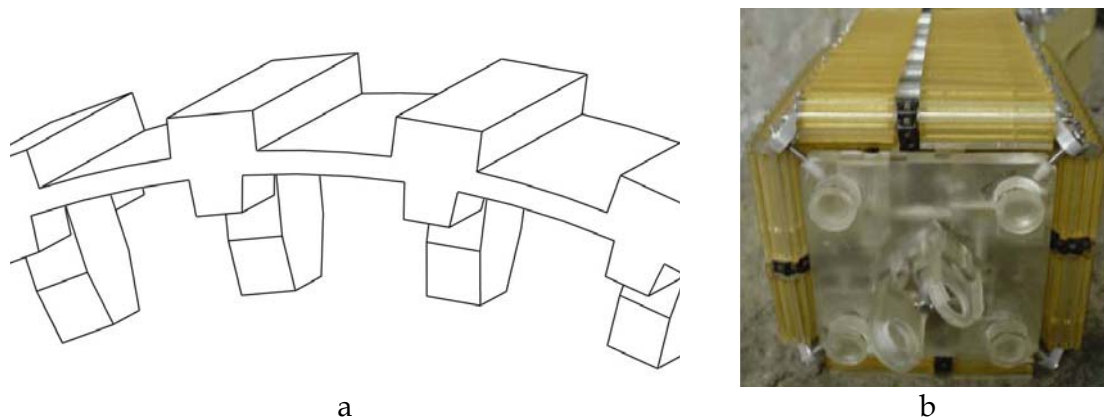

**Fig. 10.** a - Profile of the OT-8's urethane tracks, b - Front view of the OT-4. The extra-wide track areas add stability and reduce the risk of rollovers.



adaptation of the rubber tracks found in the Fast Traxx remote-controlled toy race car made by Tyco. The trapezoidal extrusion on the bottom of the track fits into a groove on the sprocket, ensuring that the track stays aligned on the sprocket. For further testing we rapid-prototyped tracks based on this design using 50 through 90 durometer urethanes.

In the much smaller OT-4 we had to simplify the gearbox; the chain is run off a sprocket mounted directly on the side of the worm gear. The chain drive is therefore off-center with respect to the driveshaft and the two tracks per side are therefore not of equal width (see Figure 10b). The tracks are molded in-house from a silicon mold. That mold is made from a Stereolithographic (SLA) rapid prototype, based on a CAD model, which we also developed in-house. The grousers have twice the pitch of the track teeth to better engage features of the obstacle being scaled. Keeping the grouser pitch a function of the tooth pitch reduces the stiffness of the track as most of the flexibility of the track comes from the thin area between the teeth. In order to increase the stability of the robot to minimize roll-overs, we made the tracks as wide as geometrically possible while still allowing the robot to fit through a 4-inch hole. The track width is especially important considering the large deflection of the center of gravity we can impose on the robot by raising three segments in the air. To meet both goals, we had to minimize the sprocket diameter, as is evident from Fig. 10b.

#### Discussion:

There are several disadvantages to small sprockets: 1. greater roll resistance, 2. reduced ability to transfer torque between the sprocket and the track, and greater sensitivity (i.e., failure rate) when driving over natural terrains such as deep sand and underbrush. On these natural terrains sand and twigs are ingested between the tracks and drive sprocket, forcing the tracks to overstretch. In most industrial environments and urban search and rescue operations, surfaces are man-made and the OT-4 performs very well on them.



**Fig. 11.** The OT-8 outperformed the OT-4 on difficult natural terrains, mostly because of the OT-8 larger track sprocket diameter. a - The OT-8 literally plowed through SwRI's underbrush test area, aided, in part, by its more massive weight and greater power. b- Unaffected by sand, the OT-8 had enough power and traction to drive up a 15° inclined bed of deep sand.

The diameter of the OT-8 track sprockets is much larger than that of the OT-4 track sprockets. Consequently, the OT-8 performed exceedingly well in deep sand and in underbrush. In order to transfer more torque, the tooth profile was kept similar to that of a timing belt, i.e., we maximized the number of engaging teeth.

#### 4.2 Chassis

The chassis of the OT-8 consists of duralumin frame with attached gearbox machined from Delrin, as shown in Fig. 12a. Most of the components including sprockets and rollers were made in house. We spent some time to reduce the weight of metal parts and to optimize their shape. As a result we obtained easy to assemble segments with a lot of spare space inside. This space could be used for energy storage or payload.

Due to the small size of the OT-4, significant efforts had to be made to organize the internal components for space efficiency and accessibility (Borenstein et al., 2006). Cables and pneumatic lines are routed with these goals in mind. For example, the electronic circuit board on each segment has a connector on each end, with the wires coming from the neighboring segments plugging into the closer side. This design eliminated the need for wire runs all the way through the segment. Similarly, instead of using air hoses we integrated all pneumatic pathways into the chassis. This was possible thanks to SLA rapid prototyping techniques, which build the parts in layers and allows for such internal features. The chassis with integrated manifold and “etched-in” pneumatic pathways is shown in Fig. 12b. SLA rapid prototyping allowed us to create very complex, and otherwise difficult to machine structures. The SLA technique also allowed us to design parts for ease of assembly, maintenance, and space savings. However, SLA resins tend to warp with time, which is why they are normally used for prototyping only. In our early OT-4 prototypes, components that were under constant load would creep with time and would cause problems, especially in the case of the seal between the valves and the manifold. Aluminum reinforcements were therefore added to the endwalls, joints and manifold at key

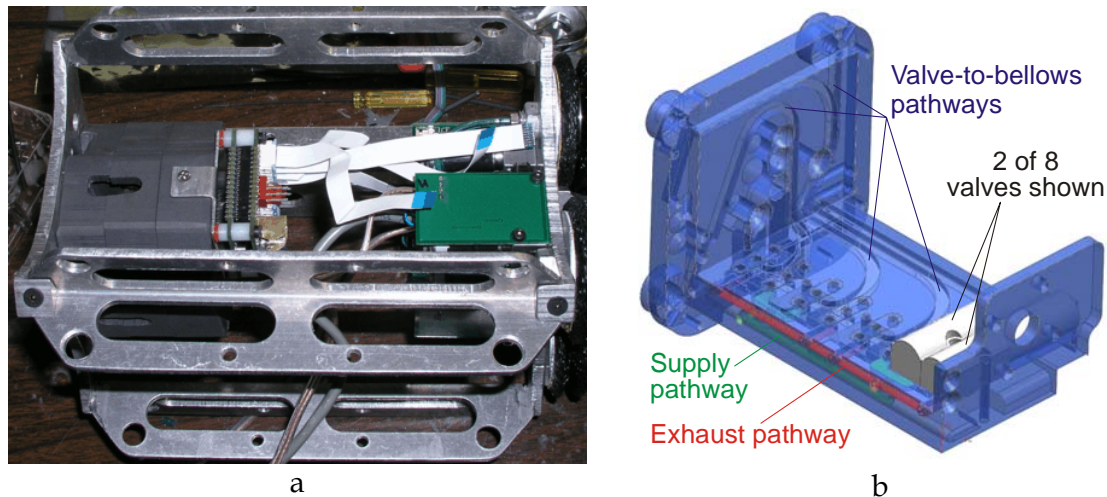

**Fig. 12.** a – Aluminum frame of the OT-8 with gearbox, controller boards and manifolds with white flat cables visible inside, b – Manifold of the OT-4 with two of the eight valves (white) mounted. Exhaust and supply pathways from and to the bellows are shown in red and green, respectively. This manifold is also partially the chassis of the six OT-4 actuation segments.

points where creep and deformation during load was becoming an issue. The endwalls were reinforced with a thin aluminum shell and the manifold was reinforced with a bar screwed on at both ends. The result was a much stiffer segment at a minor (2.5%) weight penalty.

### 4.3 Joints

Between any two segments there are two concentric universal joints referred to as the “outer” and “inner” universal joint. The outer universal joint connects the two adjacent segments. It is made of two forks and a ball bearing-mounted gimbal connecting the two forks, as shown in Figure 13a. The inner universal joint (not shown) connects adjacent segments of the drive shaft spine and is concentrically located inside the gimbal. All components of the outer universal joint are made from aluminum and each fork is screwed onto the adjacent segment endwalls. Two Hall-effect angle sensors are mounted on one arm of each fork, respectively, provide position feedback for the control of the joint angles. The joint can be actuated at least  $33^\circ$  in any direction and up to  $41^\circ$  in the four principal directions (up, down and side to side). Wiring and pneumatic lines between the segments pass through four holes at the corners of the gimbal and the bases of the forks. Each joint is orientated with respect to each other in a way so as to compensate for gimbal error, the angular twisting deviation that occurs between the two ends of a universal joint as it is articulated. Without this, three fully articulated joints would lead to each progressive segment being twisted about the drive spine axis leading to instability and impeding obstacle traversal. It should be noted that the space available for the mechanical joints is extremely limited as it is shared with the bellows of the Integrated Joint Actuator (see Fig. 13b). Moreover, space is limited because we try to dimension the bellows with the largest possible diameter to increase their force capacity, as explained next.

### 4.4 Pneumatic Bellows

Pneumatic bellows develop axial force according to

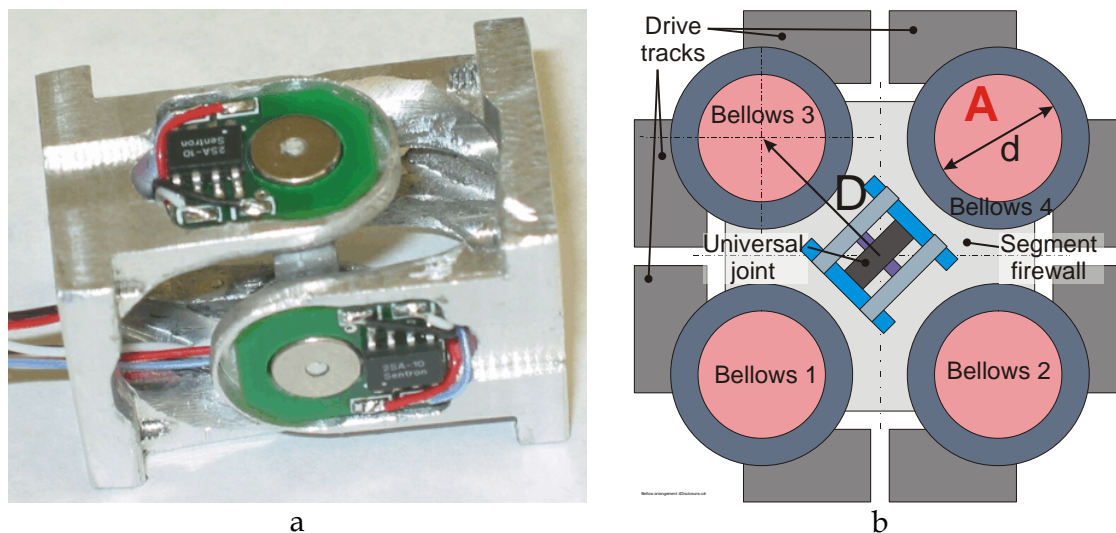

**Fig. 13.** a – Outer universal joint, with Hall-effect joint angle sensor. b – Cross-section of the Integrated Joint Actuator.



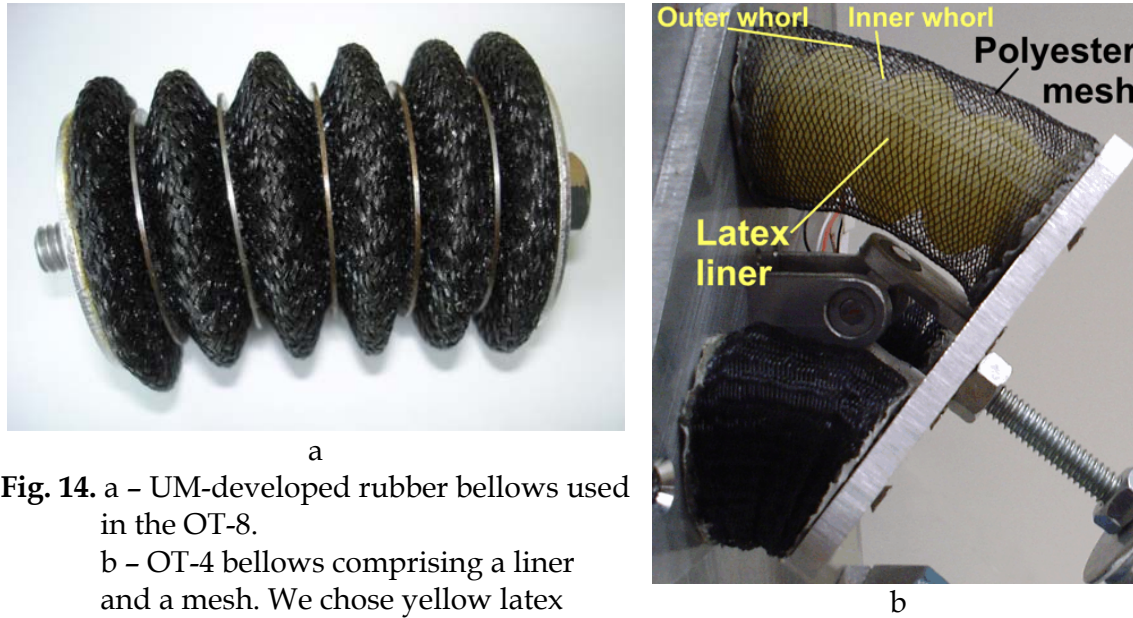

**Fig. 14.** a - UM-developed rubber bellows used in the OT-8.  
 b - OT-4 bellows comprising a liner and a mesh. We chose yellow latex liner material for this photograph because it contrasts better with the black mesh. However the actual OT-4 bellows have neoprene (black) liners.

$$F = PA \quad (2)$$

where  $P$  is the pressure of the compressed air and  $A$  is the area of the bellows surface that is normal to the axial direction, that is, the area of the cross section. One problem with Eq. (2) is the difficulty in determining exactly what the area  $A$  is. For example, in the bellows shown in Figure 14a, the convolutes change the diameter and thus the area of the cross section along the bellows. Of particular concern is the minimal cross section area,  $A_{min}$ , which corresponds to the inner whorl of the convolutes. For a given pressure  $P$ , the axial force that the bellows can apply is limited by the cross section area of the inner whorls,  $A_{min}$ . Yet, the volume of space that the bellows requires is determined by the diameter of its outer whorls. In the relatively large OT-8, the ratio between inner and outer diameter of the whorls (we refer to this ratio as “bellows efficiency”) is fairly close to 1.0. However, in the smaller bellows of the OT-4, the bellows efficiency is much smaller than 1.0. In many conventional bellows the diameter of the inner whorl increases when inflated, thereby improving that bellows’ efficiency. However, our OT-8 bellows design uses a metal ring around the inner whorls to prevent the bellows from ballooning. At the same time, these rings prevent the inner whorls from growing in diameter, thereby keeping the bellows efficiency low. To overcome this problem in the small-sized OT-4 bellows, we abandoned the metal rings altogether. Instead, we encased the OT-4 bellows in a tubular polyester mesh. To distinguish between these parts, we call the airtight, elastic part of the bellows “liner,” and the outer part “mesh.”

The new two-part bellows of the OT-4, shown in Figure 14b, has the significant advantage of allowing the diameter of the inner whorl to grow when pressurized, until the inner whorl is practically flush with the mesh. The result is a bellows that has an efficiency of close to 1.0, when fully pressurized.



There is, however, one problem with all bellows designs: When the bellows extends beyond the natural length of the liner, the axial extension force  $F = PA$  has to work against the elasticity of the liner. Similarly, when a bellows in a joint is compressed beyond a certain limit (e.g., because the bellows on the opposite site is expanding), its liner and mesh develop elastic forces that resist further compression with increasing force.

As a result of these effects, the moment produced by the bellows when installed inside a joint is neither constant nor depending only on the applied pressure differential. Rather, the produced moment is a non-linear function of the joint's momentary angle. For extreme joint angles, the moment produced by the joints may be reduced by as much as 50% compared to the maximal moment that's available when the joint is in its neutral position. In the OT-4, however, we dimensioned the bellows so as to be powerful enough to lift three segments even at near-maximal joint angles.

#### **4.5 Power**

In the OmniTread OT-8 prototype, electric and pneumatic energy, as well as control signals are provided through a tether - a 1 cm thick and 10 m long cable comprising six wires and a pneumatic pipe. Compressed air is supplied from an off-board compressor and distributed to the control valves from a single pipe running through the center of the robot. In the experiments described in the next section the compressor provided variable pressure from 85 to 95 psi but the control system limited the maximum pressure in the bellows to 80 psi.

Of course, a tether is highly undesirable for most inspection and surveillance tasks. That's why, when we designed the OT-4, we incorporated all energy resources onboard, and provided it with wireless communication. The OT-4 has Li-Pol batteries in Segments #3 and #5. Pneumatic energy, that is, compressed air, is produced onboard by two miniature air compressors, one each in Segments #2 and #6. Fully charged Li-Pol batteries allow the OT-4 to drive for 75 minutes on flat terrain. On very difficult terrain the run time is shorter.

A unique means for preserving electric power are the OT-4's micro-clutches, which allow it to engage or disengage each individual track from the main drive shaft. Disengagement of tracks not in contact with the ground results in a significant saving of electric energy. For instance, on flat ground only three tracks need to be engaged: the ones on the bottom of Segments #2, #3 and #6, while the other segments are slightly lifted off the ground. This configuration provides stable, 3-point contact and steering is accomplished by the joint between Segments #2 and #3.

## **5. Control System**

### **5.1 The Simplified Proportional Position and Stiffness Controller**

In our paper (Granosik & Borenstein, 2004) we proposed a control system called "Proportional Position and Stiffness" (PPS) controller. The PPS system is designed to do what its name implies: it allows for the simultaneous and proportional control of position and stiffness of pneumatic actuators. The PPS controller is further optimized for use in mobile robots, where on-board compressed air is a valuable resource. To

this end, the PPS employs a uniquely designed system of valves that assures that compressed air is consumed only during commanded changes of pressure or stiffness, but not while an actuator is held at a constant pressure and stiffness.

However, the PPS controller as described in (Granosik & Borenstein, 2004) is based on an approximated model of cylinders and requires the real-time measurement of certain system parameters. For example, the polar moment of inertia of masses that are being moved by the joint must be known at all times, as well as the torque needed to move the joint. In complex environments where the serpentine robot may be laying on any side, additional sensors would be needed to measure these parameters.

Because of these difficulties we simplified the control system so that these sensors are not needed, while maintaining acceptable performance. In order to distinguish the simplified control system from the proper control system, we call it "Simplified Proportional Position and Stiffness" (SPPS) controller. The SPPS controller uses a PID position controller with a stiffness control subsystem, as shown in Figure 15.

The task of the control system is to control the position of a joint, as well as its stiffness. The controlled parameters are the pressures  $p_A$  and  $p_B$  in the bellows-pair that actuates the joint. In order to control  $p_A$  and  $p_B$ , the PID controller generates the control signal  $u$  as input for the valve control subsystem. This subsystem realizes the stiffness control and air flow minimization by activating the four pneumatic valves according to the flow chart in Figure 16. In every control cycle only one of the four valves is active, i.e. generates airflow to or from one of the bellows.

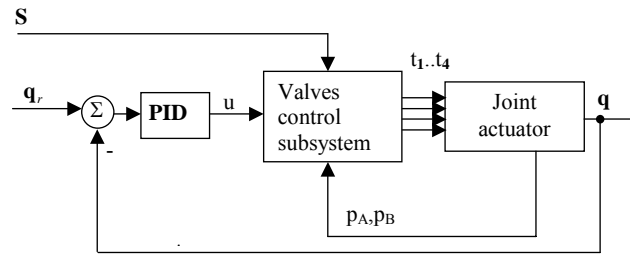

Fig. 15. Block diagram of the Simplified Proportional Position and Stiffness (SPPS) system with zero air consumption at steady state.

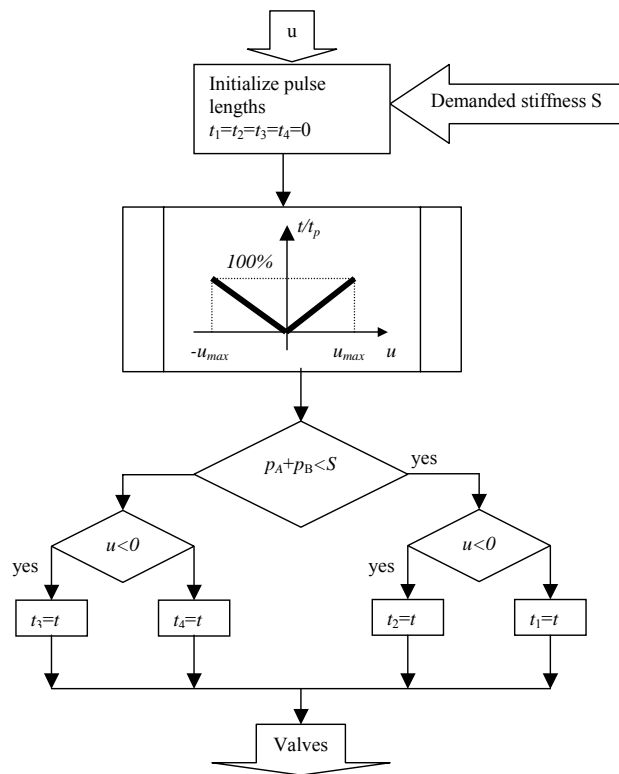

Fig. 16. Flow chart for the valve control subsystem.

The SPPS assigns higher priority to stiffness when conflicts between position control and stiffness control arise. However, the SPPS control system cannot change the stiffness of a joint in steady state because the valve control subsystem is activated by position errors only. As our experiments showed, however, this limitation can easily be accommodated by the teleoperators or by an onboard computer, in future, more advanced OmniTread models.¶

### 5.2 Control System Hardware

The four joints of the OT-8 prototype are actuated by a total of 16 pneumatic bellows. With this design the OT-8 has 25 individually and proportionally controllable parameters, namely:  $4 \times 2$  DOF position,  $16 \times$  pressure, and  $1 \times$  speed forward/backward.

In order to control the OmniTread we developed a microprocessor-based distributed control system consisting of five local controllers – one for each IJA and one for the motor. Each local controller is based on a 16-bit Motorola MC9S12DP256B microcontroller and all five controllers communicate with a master PC via CAN bus. A schematic diagram of the control system is shown in Figure 17.

We used the same structure of control system in case of OT-4. However, as this robot has six joints the number of controllable parameters is even larger than that in the OT-8. To reduce the number of controllable parameters we decided to control the stiffness of each IJA (i.e., a group of four bellows) instead of the stiffness of each individual

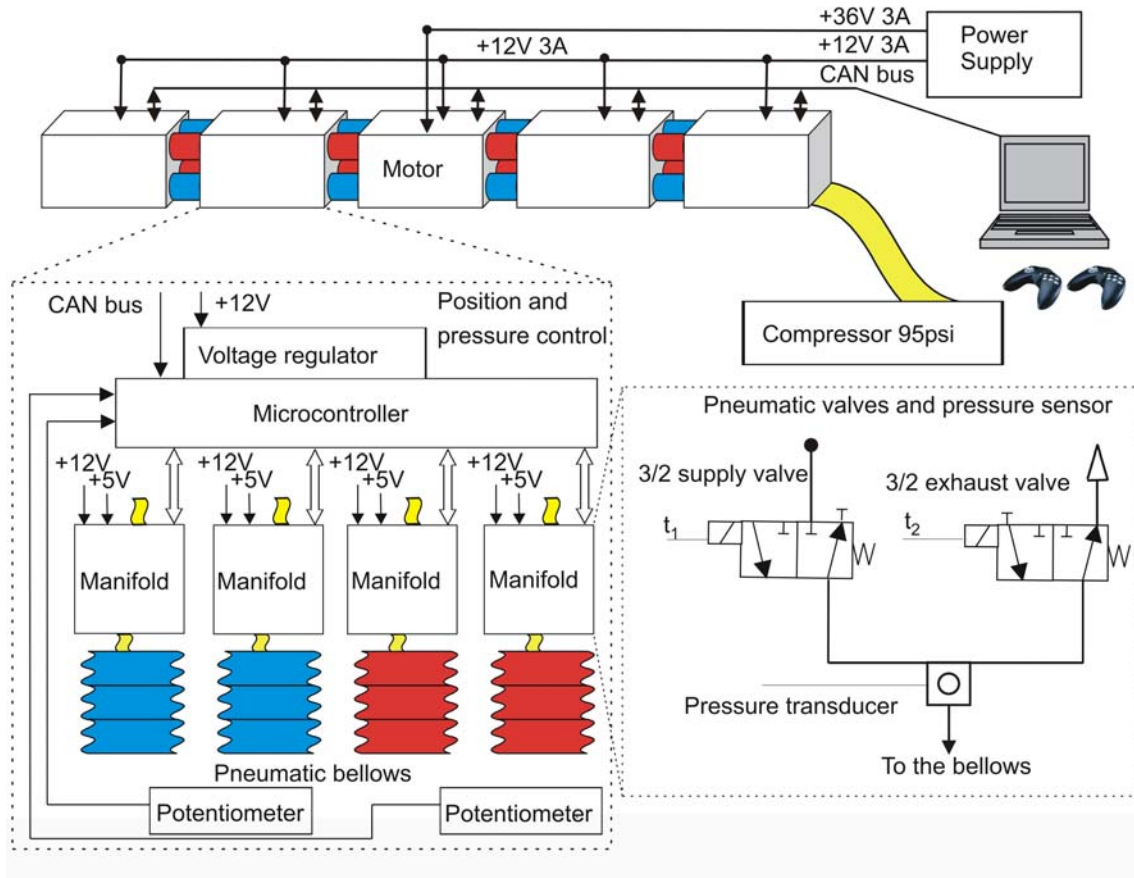
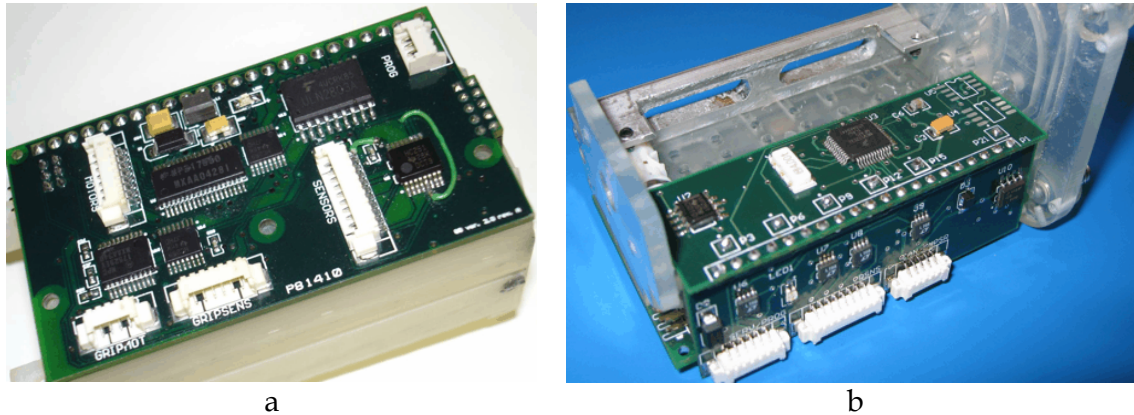

Fig. 17. Schematic diagram of the OmniTread control system, shown for the OT-8.



**Fig. 18.** Electronic control circuit boards in the OT-4.

- a Main Joint Controller board. One each of these double-sided boards is installed in each to of the six Actuation Segments. These boards perform (i) communication via the CAN bus, (ii) PWM control of the eight valves per segment, and (iii) control of the micro-clutches, as well as (iv) measurements of joint angles and bellows pressures.
- b Auxiliary Controller board. One each of these angled PCBs is installed in each of the six Actuation Segments. These boards provide added sensing and control capability, including: System pneumatic pressure sensor, PWM compressor control switch, four (4) force sensor inputs (for future work), PWM servo control output. Not all of the outputs are needed in all of the segments.

bellows. This reduces the number of controlled parameters to  $6 \text{ joints} \times 2 \text{ DOF} + 6 \times \text{stiffness} + 1 \times \text{speed} = 19$  parameters. It was also necessary to fit the controller boards into the very small space of the OT-4 segments. Moreover, additional functions in the OT-4, such as micro-clutches, require additional circuitry.

In order to accommodate all of this circuitry, we split the functions into one Main Controller board and another Auxilliary Controller board, as shown in Fig. 18. Each Main Controller board manages the position and stiffness control for its adjacent 2-DOF joint. The microcontroller can receive new position and stiffness commands and return feedback data (two positions and four pressures) every 10 ms. Each microcontroller sends digital PWM signals to eight on-off pneumatic valves (two for each bellows) to implement the Simplified Proportional Position and Stiffness (SPPS) controller described in detail in Section 5.1. Each microcontroller also reads positions from two Hall-effect angle sensors and pressures from four pressure transducers.

While the electronic circuit boards of the six Actuation Segments are identical, the

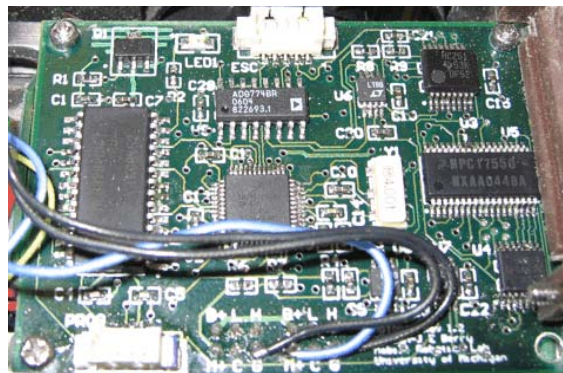

**Fig. 19.** Drive Motor Controller Board.

This board generates the PWM signals for the off-the-shelf digital power amplifier for the OT-4 motor.



Motor Segment has its own unique control board, shown in Fig. 19. The board produces PWM signals needed to as input for the commercial, off-the-shelf electronic speed controller (ESC) (not shown). The Motor Controller board has digital inputs and an analog multiplexer for telemetry sensors. The board reads sensors for battery voltages, motor current, and motor shaft speed, as well as motor and ESC temperatures. Not shown in Fig. 19 is the off-the-shelf speed controller that actually drives the motor.

## 6. Features Found only in the OT-4

Up to this point we discussed mostly features and properties that are common to the OT-8 and the OT-4. However, the OT-4 has several unique features that are not found in the OT-8. We discuss the most salient of these features in this section.

### 6.1 Completely Tetherless Operation

The OT-8 requires three resources to be supplied to the robot through a tether: Electric power, compressed air at 80 psi, and control signals. In order to make the OT-4 entirely tetherless, these resources had to be supplied onboard. We will briefly discuss here how these onboard supplies were implemented.

#### 6.1.1 Electric power

The OT-4 has two electric power circuits: a motor power circuit and a control power circuit.

- a. The motor power circuit powers the drive motor and the two onboard compressors. This power is supplied by two 7.4 V, 2,000 mAh Li-Pol batteries, one each stored in Segments #3 and #5 (Fig. 20). The two batteries are connected in series to provide 14.8 V and their total energy storage capacity is 29.6 Wh. These batteries take up a volume of 84 cm<sup>3</sup> and weigh a total of 160 g.
- b. The control power circuit powers the electronics control boards and pneumatic valves, as well as the wireless communication system. This power is supplied by two 7.4 V, 730 mAh Li-Pol batteries, one in Segments #3 and one in Segment #5. The two batteries are connected in parallel to provide 1,460 mAh at 7.4 V and their total energy storage capacity is 10.8 Wh. These batteries take up a volume of 34 cm<sup>3</sup> and weigh a total of 76 g.

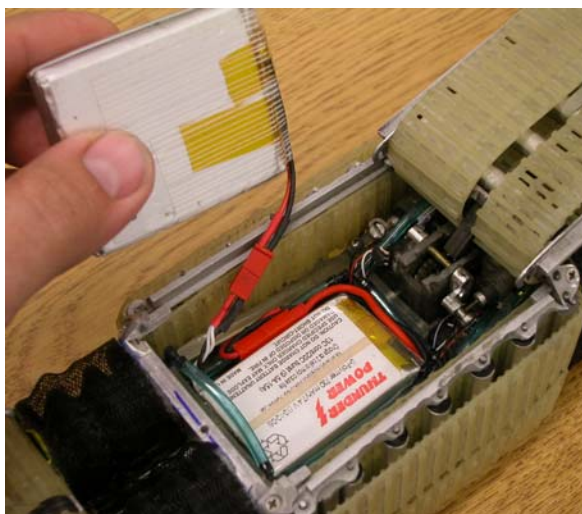

**Fig. 20.** The 730 mAh Li-Pol battery is in its place in Segment #5. The remaining space will be completely filled by the 2,000 mAh Li-Pol battery in the engineer's hand.

In the endurance test (driving as far and long as possible on one charge on flat concrete floor) the motor power and the control power batteries lasted roughly the same time (75 minutes). On extremely difficult obstacles, where joints are actuated a

lot and all tracks are engaged, the motor battery can be depleted in as little as 25 minutes.

### 6.1.2 Pneumatic power

Pneumatic power is supplied by two off-the-shelf Hargraves CTS mini-compressors, shown in Fig. 21. In order to increase the flow rate we added another compressor head to the motor so that in one revolution of the crankshaft, two pistons go through a compression cycle. Since the stock motor was therefore under a larger load the flowrate wasn't doubled but it was increased significantly. We then further modified these compressors by replacing the stock motor by a more powerful one, the Faulhaber Model 2232 012 SR. The Faulhaber motor is coreless, slightly larger (22 mm as opposed to 20 mm) and has a higher power rating. Because of that higher rating, it draws only 1/3 the current of the stock motor, which was somewhat overloaded when running two heads.

In this configuration, the compressor provides about 25 psi (less when flow rates are high). This maximal pressure is sufficient for most ordinary tasks with the OT-4,

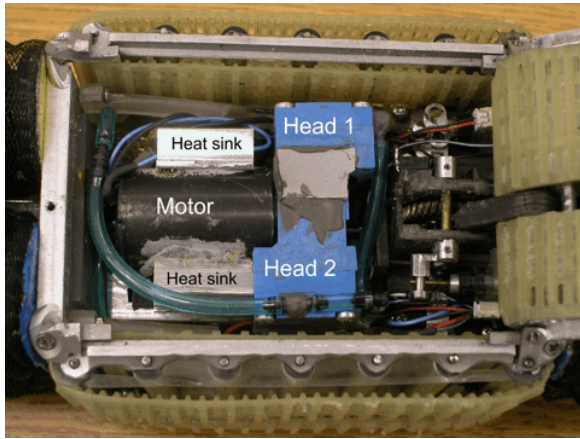

**Fig. 21.** (above) Modified dual-head air compressor installed in Segments #2 and #6.

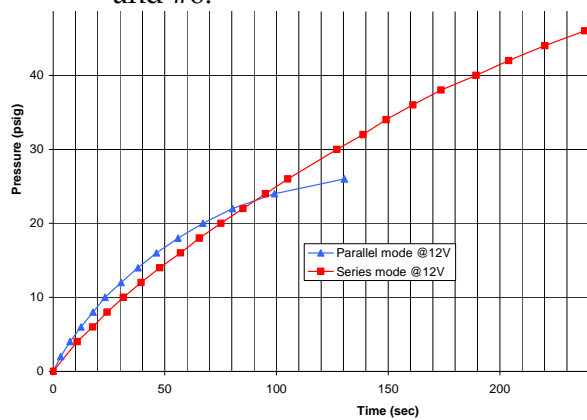

**Fig. 23.** Plot of pressure versus time required to fill a fixed test volume (2.1 liter) with air at different pressures. Comparison of dual-pressure compressor working in series (blue) and parallel (red) mode. This chart is for one compressor, although the OT-4 uses two compressors.

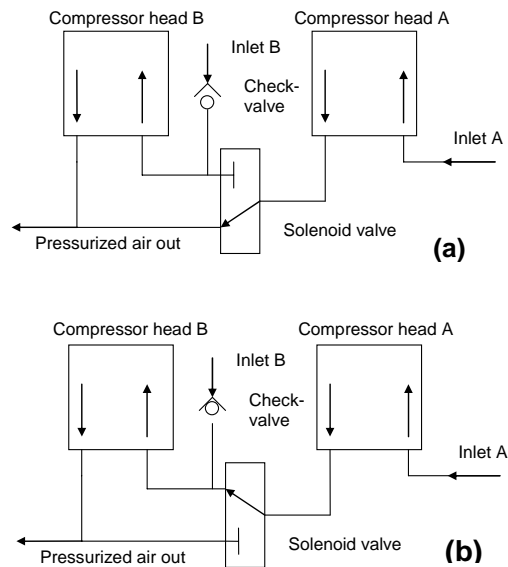

**Fig. 22.** (above) The dual-pressure compressor system. The compressor heads can be switched between (a) Parallel Mode and (b) Series Mode by switching the state of the solenoid valve.

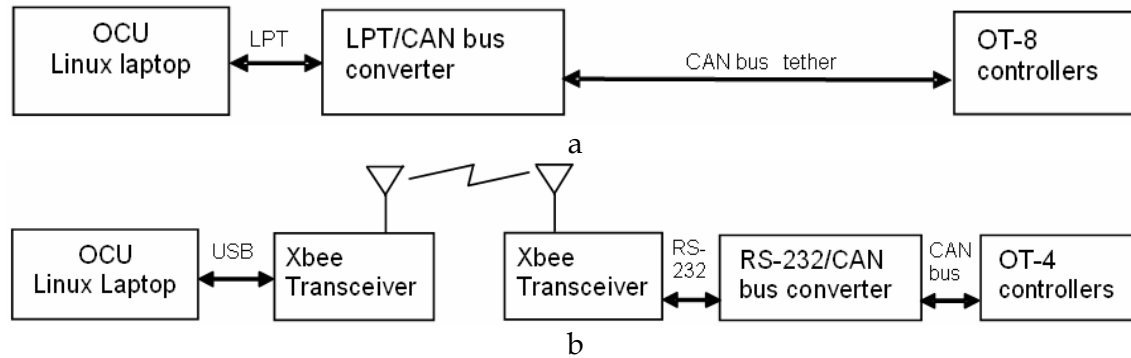

**Fig. 24.** Control communication system components. a – tethered system for OT-8. b – wireless system for OT-4.

since its bellows were specifically designed for a much lower operating pressure than that of the OT-8. However, for extreme task, such as the vertical climb in large-diameter pipes and other tasks with vertical motion requirements, a higher pressure would be desirable. That's because higher pressures translate into proportionally greater joint actuation torques. To achieve this higher pressure we connected the two heads in series, increasing the effective output pressure of one compressor up to 50 psi. Implementing the pneumatic diagram of Fig. 22, it is possible to switch the two compressor heads between series and parallel mode, by means of a single solenoid valve and a check-valve. In principal, switching can be done anytime during operation, without stopping the compressors, but at the time of writing this chapter we have not yet found a small enough solenoid valve with high enough flow rate to make the design beneficial.

We measured the output (pressure and flow rate) of both compressor modes by connecting the outlet of one of the two compressors to a 2.1-liter container and timing how quickly it built pressure. The results are shown in Fig. 23. As can be seen, low pressures up to 15 psi can be built faster in Parallel Mode. Pressures above ~15 psi build up faster in series mode.

### 6.1.3 Wireless Control Communication System

In the OT-8 the communication of control signals from the joysticks (via a laptop) to the robot and sensor signals from the robot to the off-board laptop were sent through the tether, as shown in Fig. 24a. In the OT-4, we implemented the wireless communication system of Fig 24b.

Our solution involved removal of the housing and other components from a Lawicel CAN-to-RS-232 converter to reduce it's volume, and wiring it to a Maxstream Xbee transceiver. Despite the complexity of the multiple-conversions system, we managed to integrate the components into



**Fig. 25.** Onboard components of the OT-4's wireless control communication system.



the OT-4's tail segment such that most of the payload space in that segment remained available. Fig. 25 shows the on-board components of the wireless communication system.

The range of the system is approximately 20 m through two walls with no apparent problems. The CAN message throughput of the wireless system is slightly lower than that of the OT-8's tethered system despite similar transmission baud rates (115.2kB vs. 125kB). This is because the messages are transmitted in the wireless system as ASCII strings rather than as binary ones.

## 6.2 Electrically actuated micro-clutches

One reason for the OT-4's impressive motor battery run time (75 minutes on benign terrain) is a unique feature in the OT-4: all 28 of its tracks can be engaged or disengaged from the drive train individually. To motivate the utility of the clutches, let's consider some figures. A torque of  $T_f = 0.09$  Nm is needed to drive a freely spinning track, that is, a track that is not engaged with any environmental feature. At the other extreme, the largest possible legitimate torque that a track may have to transfer is needed during vertical pipe climbs. During such climbs, one track of the center segment is pressed against the inside wall of the pipe and has to support half the robot's weight. Under this condition the torque required to turn that track is  $T_m = 0.21$  Nm. Comparing these two extreme torque requirements shows a ratio of  $q = T_m/T_f = 2.3$ . The significance of this ratio is that driving 2.3 tracks at the lightest possible load (i.e., spinning freely) requires the same amount of torque as driving one track under the largest possible load condition. Since torque is roughly proportional to power consumption, we conclude that idling 2.3 tracks consumes as much power as driving half the robot's weight vertically. It is thus obvious that *not* driving an idle track will save a substantial amount of onboard electric power.

In practice we implemented the micro-clutches as shown in Fig. 26. To disengage a track, a micro motor moves one link of a four-bar mechanism so that the worm gear is lifted off the worm. Micro-switches (not shown here) stop the micro-motor in two stable, self-locking positions. These positions correspond to the worm gear being fully engaged or disengaged from the worm.

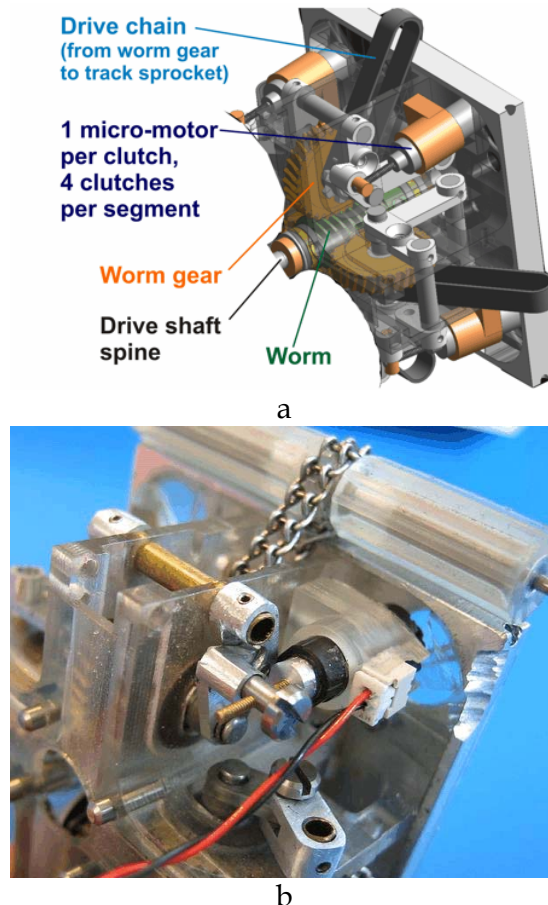
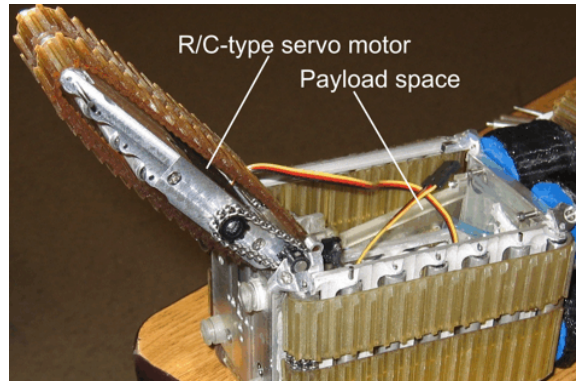

Fig. 26. Gear box and micro-clutches. a - CAD drawing, b - photograph



### 6.3 Flipper tracks

We equipped the OT-4 with two so-called “flipper tracks.” These tracks, located in the lead and tail segments, can be “flipped out” or “flipped in” to extend the reach of the OT-4. The extended reach is useful in two maneuvers: (a) to cross gaps and (b) to reach up and over high obstacles. The flipper track uses a small servo embedded in the track tray to extend the flipper 180° or to retract it. An additional locking actuator locks the track in either position. The servo is slightly wider than the height of the track, resulting in the outward bulge of the track, apparent in Fig. 27. Yet, the bulge does not interfere with the robot’s ability to pass through a 10-cm hole. The new design functioned very well when we used it to overcome the knife-edge hole obstacle (see Fig. 6, back in Section 3.3), as well as in other tests, not documented here.



**Fig. 27.** Flipper track during deployment to its fully extended position.

## 7. Experimental Results

In order to assess the performance of our robots under realistic and objective conditions, the OmniTreads (OT-8 and OT-4) were tested at the Small Robotic Vehicle Test Bed at the Southwest Research Institute (SwRI) in San Antonio, Texas. The OT-8 robot was tested in 2004, while the OT-4 was tested in 2006.

During these tests the OmniTread OT-8 was continuously controlled by two operators who had audio and visual contact with the robot, allowing them to monitor the robot’s behavior at all times. The OT-4 required three trained operators to run. The SwRI test facility is well designed and allows for the objective assessment of vastly different small robot designs. Among the tests were tasks such as climbing over high steps, ascending through the inside of pipes, traversing wide gaps, and many more. A detailed description of all tests and their results would far exceed the scope of this chapter. Rather, we refer the reader to the many photographs in this chapter and point out that in each of the depicted scenarios, the robot successfully completed the run or passing the obstacle. The same is true for the photographs in Figure 28, which shows some more test environments and obstacles (some from SwRI, some from our own lab).

In addition, Table 2 provides some technical specifications and comments on performance. Lastly, video clips are very particularly helpful in conveying a sense of the capabilities of serpentine robots. We therefore refer the reader to our large video library on the web at

[http://www.engin.umich.edu/research/mrl/OmniTread\\_Video.html](http://www.engin.umich.edu/research/mrl/OmniTread_Video.html).

**Table 2.** Comparison of OT-8 and OT-4 parameters and performance

Parameter	OT-8	OT-4
<b>Specifications</b>		
Smallest hole robot can pass through	20 cm (8 inches) diameter	10 cm (4 inches) diameter
Dimensions (length, width, height)	127×18.6×18.6 cm	94×8.2×8.2 cm
Number of segments	5	7
Joint segment length	20 cm	10.3 cm
Motor segment length	20 cm	10.9 cm
Joint length	6.8 cm	3.6 cm
Weight	13.6 kg	(Incl. batteries & flippers) 4.0 kg
Power	Off-board lead-acid batteries and air compressor (80 psi). Both resources brought to robot via tether	On-board: Li-pol batteries (43 Wh), 2 air compressors (45 psi) On-board resources sufficient for 75 minutes driving on smooth terrain
Control	2 operators, 2 gamepads, off-board laptop	3 operators, 2 gamepads, off-board laptop
Controls signals	CAN bus, via tether	Wireless serial link, no tether
<b>Special features</b>		
Common features to both OT-8 and OT-4	Extra-wide tracks on all four sides of robot	
	Pneumatic joint actuation with position & stiffness control	
	Single drive motor, drive shaft spine	
	Requires tether	Completely untethered
	No micro-clutches needed, since electric power “free” with tether	Electrically actuated micro-clutches to engage/disengage each track
		Flipper tracks extend reach of lead & tail segment by 8 cm
	Supply pressure variable since compressor off-board	On-the-fly switchable maximal supply pressures: 30 & 45 psi
	Very strong components, since not optimized for weight & space	Mech. overload protection for each branch of drive train by shear pins
<b>Performance</b>		
Maximal velocity	10 cm/s	15 cm/s
Minimum turning radius (inside)	53 cm	16 cm
Performance on rocks or rubble	Excellent. Never failed a test.	Excellent. Never failed a test.
Performance on stairs	Poor. Can climb only stairs with small slopes, long treads	Excellent. Successfully climbed different combinations of rise/tread, up to 40°
Performance in deep sand	Excellent, able to climb 15° slope can drive indefinitely	Very poor. Cannot climb any slope. Stalled after 5 meters
Performance in underbrush	Excellent, plows through, can drive indefinitely	Poor. Ingests twigs, grass, stalled after 12 meters
Climbing in PCV pipe, diameters	30 cm	10 cm, 15 cm, 20 cm
Maximal inclination of pipe	22°	90° (vertical)
Maximal height of vertical wall climbed	46 cm (2.5× own height)	40 cm (4.9× own height) Higher with flipper (not tested)
Width of largest gap crossed	66 cm (52% of own length)	49 cm (52% of own length)



**Fig. 28.** OmniTread testing in different challenging environments:

a. OT-4 climbing up and over a 40-cm (15.5") high wall (5× the robot's height).

b. OT-4 traversing a gap 49 cm (19.25") wide. This is 52% of its length.

c. OT-4 climbing up inside a 4-inch diameter PVC pipe. Speed: 8 cm/s.

d. OT-4 climbing up inside a 8-inch diameter PVC pipe. Speed: 6 cm/s.

e. OT-4 climbing up steep stairs sloped 40°

f. OT-4 inside an 8-inch diameter pipe, halfway through a 90° elbow

## 8. Conclusion

This paper introduced the Omnis family of serpentine robots. Serpentine robots have the potential to provide hitherto unattainable capabilities, such as climbing over high steps, travel inside horizontal or even vertically pipes, or traversing wide gaps. While individual tasks of this nature have been tackled in the past by special-purpose mobile robots (e.g., pipe crawlers), it appears that only serpentine robots may be able to perform a large variety of difficult tasks.

We started our project with the design of the legged OmniPede. Technical evolution then led to the design of the OmniTread OT-8, and finally to our most advanced model, the OT-4. We believe that the OmniTread robots have a particularly high potential to become truly practical.

Notable in the OmniTread are several innovative features as summarized here:

- Pneumatically actuated 2-DOF joints – The 2 DOF joints of the OmniTread are actuated pneumatically. Pneumatic actuation provides natural compliance with the terrain for optimal traction and shock absorption, as well as a very high force-to-weight ratio.
- Bellows used as pneumatic actuators – Bellows are ideal for serpentine robots because they fit naturally into the space occupied by the joints. This minimizes the need for space, especially space not covered by propulsion elements. In addition, bellows can expand to four times their compressed length. (US Patent #6,870,343).
- Proportional Position and Stiffness Control system – The pneumatic control system, developed at our lab especially for serpentine robots, allows simultaneous, proportional control over position and stiffness of each individual bellows. In addition, the system uses compressed air only when changing the position or the stiffness of a bellows. Thus, during long stretches of straight travel no compressed air is used at all. (US Patent #6,870,343).
- Maximal coverage of robot surface with moving tracks – In this paper we identified and formalized the need for maximizing the so-called “Propulsion Ratio,”  $P_r$ . We implemented this design doctrine by covering all sides of all segments with extra-wide, moving tracks. The cost for this approach is additional complexity. The cost for not using this approach is mission failure when the robot gets stuck on troublesome terrain (US Patent #6,774,597).
- Single drive motor for all segments and drive shaft spine – Our analysis shows that a single drive motor is more energy, weight, and space-efficient than multiple motor configurations (i.e., one motor in each segment). Motor power is transferred to the segments via a drive shaft spine that runs the length of the robot. Within each segment the drive shaft spine is a rigid axle, connected to the axle in neighboring segments via a universal joint (not a flexible shaft). (US Patent #6,512,345).¶

We are currently working on the higher level control system for Serpentine robots. A problem with high-degree-of-freedom (HDOF) serpentine robots is that they often require more than one human operator. In the case of the OT-4, three operators simultaneously control the robot using six individual joysticks as well as auxiliary instrumentation.



In order to reduce the number of operators needed, we developed a "Haptic Operator Console" (HOC), which we call the Joysnake (as in joy-stick.) The premise of the Joysnake is that the fastest and most intuitive method for a human operator to command a pose for a High Degree of Freedom robotic mechanism is to shape an adjustable replica of the mechanism into the desired pose (Baker & Borenstein, 2006). In most simple to moderately difficult task the Joysnake works sufficiently well to replace the three operators by just one. However, in very complex task the three operators perform better.

## **Acknowledgements**

This work was funded by the U.S. Dept. of Energy under Award No. DE FG52 2004 NA25587 as well as by the Intelligence Technology Innovation Center under Grants #F013596 and F013019.

The authors are grateful to the OmniTread OT-4 development team for their full-time efforts: Jack Phan, Russ Miller, Jim Berry, Justin Tesmer, Adam Borrell, Oke Liimatta, Hung Nguyen, and John Baker. We are also grateful to David Thomas, Jenny Weinberg and the many machinists who worked on the OT-4 part-time.

We are also grateful to Dr. William Hutchison who developed the "7G" computerized learning program. This program produced the sophisticated and complex motion strategy used for traversing the steep staircase in Fig. 7 and Fig. 28c.

## **8. References**

- <sup>1</sup> Blitch, J.G. (2003). Adaptive Mobility for Rescue Robots, *Proc. of SPIE. Sensors, and Command, Control, Communications, and Intelligence (C3I) Technologies for Homeland Defense and Law Enforcement II*, vol. 5071, pp. 315-321.
- Brown, H.B., Jr.; Vande Weghe, J.M.; Bererton, C.A.; Khosla, P.K. (2002). Millibot trains for enhanced mobility, *IEEE/ASME Transactions on Mechatronics*, Vol. 7, Issue 4, pp. 452-461.
- Borenstein, J.; Hansen, M.G. & Nguyen, H. (2006). The OmniTread OT-4 Serpentine Robot for Emergencies and Hazardous Environments, *2006 Int. Joint Topical Meeting: "Sharing Solutions for Emergencies and Hazardous Environments,"* February 2006, Salt Lake City, Utah, USA.
- Granosik, G. & Borenstein, J. (2004) Minimizing Air Consumption of Pneumatic Actuators in Mobile Robots, *Proc. IEEE Int. Conference on Robotics and Automation*, New Orleans, pp. 3634-3639.
- Granosik, G. & Borenstein, J. (2005). Integrated Joint Actuator for Serpentine Robots, *IEEE/ASME Transactions on Mechatronics*, Vol. 10, pp. 473-481, October 2005.
- Hirose, S. (1993). *Biologically Inspired Robots (Snake-like Locomotor and Manipulator)*, Oxford University Press.
- Hirose, S. & Morishima, A. (1990). Design and Control of a Mobile Robot With an Articulated Body, *The International Journal of Robotics Research*, Vol. 9, No. 2, pp. 99-113.

- Hirose, S.; Morishima, A.; Tukagosi S.; Tsumaki T.; Monobe, H. (1991). Design of Practical Snake Vehicle: Articulated Body Mobile Robot KR-II, *Fifth Int. Conference on Advanced Robotics, 'Robots in Unstructured Environments'*, Vol. 1, pp 833 -838.
- Kamegawa, T.; Yamasaki, T.; Igarashi, H.; Matsuno, F. (2004). Development of the Snake-like Rescue Robot KOHGA, *Proc. IEEE Int. Conf. on Robotics and Automation*, New Orleans, LA, April, pp. 5081-5086.
- Kimura, H. & Hirose, S. (2002). Development of Genbu: Active wheel passive joint articulated mobile robot, *Proc. IEEE/RSJ Int. Conference on Intelligent Robots and System*, Vol.1, pp. 823 -828.
- Klaassen, B. & Paap, K.L. (1999). GMD-SNAKE2: A Snake-Like Robot Driven by Wheels and a Method for Motion Control, *Proc. IEEE Int. Conference on Robotics and Automation*, Detroit, MI, May 10-15, pp. 3014-3019.
- Long, G.; Anderson, J.; Borenstein, J. (2002). The OmniPede: A New Approach to Obstacle Traversal. *Proc. IEEE Int. Conf. on Robotics and Automation*, USA, pp. 714-719.
- Mori, M. & Hirose, S. (2002). Three-dimensional serpentine motion and lateral rolling by active cord mechanism ACM-R3, *IEEE/RSJ International Conference on Intelligent Robots and System*, pp. 829-834 vol.1.
- Ohno, H. & Hirose, S. (2000). Study on slime robot (proposal of slime robot and design of slim slime robot), *Proc. IEEE/RSJ Int. Conference on Intelligent Robots and Systems, (IROS 2000)*, pp 2218-2223, Vol 3.
- Osuka, K. & Kitajima, H. (2003). Development of Mobile Inspection Robot for Rescue Activities: MOIRA, *Proc. IEEE/RSJ Int. Conference on Intelligent Robots and Systems*, Las Vegas, Nevada, pp. 3373-3377.
- Paap, K.L.; Christaller, T.; Kirchner, F. (2000). A robot snake to inspect broken buildings, *Proc. IEEE/RSJ Int. Conference on Intelligent Robots and Systems*, pp. 2079-2082.
- Schempf H., Mutschler, E., Goltsberg, V. , Skoptsov, G., Gavaert, Vradis, G. (2003). Explorer: Untethered Real-time Gas Main Assessment Robot System, *Proc. of Int. Workshop on Advances in Service Robotics, ASER'03*, Bardolino, Italy.
- Scholl, K.U.; Kepplin, V.; Berns, K.; Dillmann, R. (2000). Controlling a multi-joint robot for autonomous sewer inspection, *Proc. IEEE Int. Conference on Robotics and Automation*, ICRA '00, vol.2, pp. 1701-1706.
- Streich, H. & Adria, O. (2004). Software approach for the autonomous inspection robot MAKRO. *Proc. IEEE Int. Conference on Robotics and Automation*, New Orleans, LA, USA, pp. 3411-3416.
- Takayama, T. & Hirose, S. (2000). Development of Souryu-I connected crawler vehicle for inspection of narrow and winding space, *26th Annual Conference of the IEEE Industrial Electronics Society, IECON 2000*, vol.1, pp 143-148.