

This discussion paper is/has been under review for the journal Biogeosciences (BG).  
Please refer to the corresponding final paper in BG if available.

# Environmental factors regulating winter CO<sub>2</sub> flux in snow-covered boreal forest soil, interior Alaska

Y. Kim<sup>1</sup> and Y. Kodama<sup>2</sup>

<sup>1</sup>International Arctic Research Center, University of Alaska Fairbanks, AK 99775–7335, USA

<sup>2</sup>Institute of Low Temperature Science, Hokkaido University, Sapporo 060–0819, Japan

Received: 22 November 2011 – Accepted: 18 January 2012 – Published: 26 January 2012

Correspondence to: Y. Kim (kimyw@iarc.uaf.edu)

Published by Copernicus Publications on behalf of the European Geosciences Union.

**BGD**

9, 1129–1159, 2012

## Environmental factors regulating winter CO<sub>2</sub> flux

Y. Kim and Y. Kodama

Title Page

Abstract

Introduction

Conclusions

References

Tables

Figures

◀

▶

◀

▶

Back

Close

Full Screen / Esc

Printer-friendly Version

Interactive Discussion



## Abstract

Winter CO<sub>2</sub> flux is an important element to assess when estimating the annual carbon budget on regional and global scales. However, winter observation frequency is limited due to the extreme cold weather in sub-Arctic and Arctic ecosystems. In this study, the continuous monitoring of winter CO<sub>2</sub> flux in black spruce forest soil of interior Alaska was performed using NDIR CO<sub>2</sub> sensors at 10, 20, and 30 cm above the soil surface during the snow-covered period (DOY 357 to 466) of 2006/2007. The atmospheric pressure was divided into four phases: >1000 hPa (HP: high pressure); 985 < *P* < 1000 (IP: intermediate pressure); <986 hPa (LP: low pressure); and a snow-melting period (MP); for the quantification of the effect of the environmental factors determining winter CO<sub>2</sub> flux. The winter CO<sub>2</sub> fluxes were 0.22 ± 0.02, 0.23 ± 0.02, 0.25 ± 0.03, and 0.17 ± 0.02 gCO<sub>2</sub>-C/m<sup>2</sup> d<sup>-1</sup> for the HP, IP, LP, and MP phases, respectively. Winter-time CO<sub>2</sub> emission represents 20 % of the annual CO<sub>2</sub> emissions in this boreal black spruce forest soil. Atmospheric temperature, pressure, and soil temperature correlate at levels of 56, 25, and 31 % to winter CO<sub>2</sub> flux, respectively, during the snow-covered period of 2006/2007, when snow depth experienced one of its lowest totals of the past 80 years. Atmospheric temperature and soil temperature at 5 cm depth, modulated by atmospheric pressure, were found to be significant factors in determining winter CO<sub>2</sub> emission and fluctuation in snowpack. Regional/global process-based carbon cycle models should be reassessed to account for the effect of winter CO<sub>2</sub> emissions, regulated by temperature and soil latent-heat flux, in the snow-covered soils of Arctic and sub-Arctic terrestrial ecosystems of the Northern Hemisphere.

## 1 Introduction

While winter CO<sub>2</sub> flux is an important carbon source in snow-covered sub-Arctic and Arctic ecosystems for the estimation of the annual carbon budget (Zimov et al., 1993, 1996; Oechel et al., 1997; Winston et al., 1997; Fahnestock et al., 1998; Kim et al., 2007), there are few reports on continuous winter CO<sub>2</sub>-flux measurements in high

**BGD**

9, 1129–1159, 2012

### Environmental factors regulating winter CO<sub>2</sub> flux

Y. Kim and Y. Kodama

Title Page

Abstract

Introduction

Conclusions

References

Tables

Figures

◀

▶

◀

▶

Back

Close

Full Screen / Esc

Printer-friendly Version

Interactive Discussion



latitudinal regions. Most studies, rather, have intermittently measured winter CO<sub>2</sub> flux with a static chamber built on the snow surface. These flux measurements are limited due to the extreme cold weather from December to February and issues with static and/or continuous chamber operation at identical sampling points, made difficult by newly accumulated snow in high latitudes. Winter CO<sub>2</sub> emissions, though, correspond to 10–30 % of the annual soil respiration rate in alpine, sub-Arctic, and Arctic regions during the long (>200-day) snow-covered period (Sommerfeld et al., 1993; Zimov et al., 1993, 1996; Brooks et al., 1996; Oechel et al., 1997; Mast et al., 1998; Wickland et al., 2001; Kim et al., 2007), suggesting that the winter carbon contribution should not be overlooked when evaluating the annual carbon budget on regional and global scales. In this study, the monitoring of continuous winter CO<sub>2</sub>-flux measurements was conducted using non-destructive infrared (NDIR) CO<sub>2</sub> sensors, installed before snowfall in black spruce forest soils during the seasonally snow-covered period of 2006/2007. These sensors have been used in temperate forests during winter before (Hirano, 2005; Takagi et al., 2005); however, this study is the first to use these sensors to report on continuous winter CO<sub>2</sub>-flux measurement in the boreal black forest of interior Alaska, under an environment of extreme cold.

The environmental factors influencing winter CO<sub>2</sub> flux are atmospheric pressure and wind speed (Massman et al., 1997; Takagi et al., 2005; Massman and Frank, 2006), atmospheric temperature (Takagi et al., 2005), soil temperature (Zimov et al., 1993, 1996; Oechel et al., 1997; Winston et al., 1997; Hirano, 2005; Monson et al., 2006), soil moisture (Hirano, 2005), and snow depth (Fahnestock et al., 1998; Takagi et al., 2005). Moreover, atmospheric pressure affects wind speed and atmospheric temperature, subsequent wind speed influences CO<sub>2</sub> fluctuation within the snowpack, and the ambient temperature modulates snow/soil temperatures. The soil temperature, depending on snow depth and atmospheric temperature, also governs the strength of microbial activity that terminally establishes the magnitude of CO<sub>2</sub> production in soils. We investigated each of these environmental factors affecting continuous winter CO<sub>2</sub>-flux measurement through the snowpack in this study.

**Environmental factors regulating winter CO<sub>2</sub> flux**

Y. Kim and Y. Kodama

Title Page

Abstract

Introduction

Conclusions

References

Tables

Figures



Back

Close

Full Screen / Esc

Printer-friendly Version

Interactive Discussion



Several process-based ecosystem carbon models (e.g. Biome-BGC, TEM, and Sim-CYCLE) have used atmospheric temperature data as one of the key parameters for the assessment of the cycle and budget of terrestrial carbon on regional and global scales (e.g. Running and Coughlan, 1988; Kimball et al., 1997; McGuire et al., 2000; Ito and Oikawa, 2002; Lagergren et al., 2006). However, the implication of winter carbon emissions in the snow-covered Arctic and sub-Arctic terrain of the Northern Hemisphere upon the regional/global carbon budget is poorly accounted for in these models. Because vegetative photosynthesis and respiration does not occur in environments of extreme cold, soil-originated CO<sub>2</sub> emission through the snowpack represents the only ecosystem respiration during the winter. Therefore, continuous winter CO<sub>2</sub> emission, dependent on environmental factors, is a significant key in the winter carbon contribution to process-based terrestrial ecosystem carbon models, as well as to the assessment of the terrestrial carbon cycle/budget on regional and global scales.

## 2 Materials and methods

### 2.1 Sampling locations and methods

The study site is a typical boreal forest in Fairbanks, in the Alaska interior (64°52' N, 147°51'W; 155 m a.s.l.). The average monthly temperature in Fairbanks between 1971 and 2005 was lowest in January at -23.2 °C, and highest in July at 16.9 °C, with an annual average of -2.9 °C (Shulski and Wendler, 2007). The average annual precipitation was 263 mm, of which approximately 37 % fell as snow, and the rest as rain. The minimum temperatures at 80 cm above the soil surface and in soil 5 cm below the surface were -45.4 °C (DOY 418 to 421) and -11.2 °C (DOY 425 to 430), respectively, during the winter of 2006/2007. The average snow depth during the winter of 2006/2007 was 25 cm; this average was the third lowest since 1929 (Alaska Climate Research Center, 2008).

**BGD**

9, 1129–1159, 2012

## Environmental factors regulating winter CO<sub>2</sub> flux

Y. Kim and Y. Kodama

Title Page

Abstract

Introduction

Conclusions

References

Tables

Figures

◀

▶

◀

▶

Back

Close

Full Screen / Esc

Printer-friendly Version

Interactive Discussion



**Environmental  
factors regulating  
winter CO<sub>2</sub> flux**

Y. Kim and Y. Kodama

Title Page

Abstract

Introduction

Conclusions

References

Tables

Figures



Back

Close

Full Screen / Esc

Printer-friendly Version

Interactive Discussion



Black spruce (*Picea mariana*) is the dominant overstory tree species, with ages from 45 to 120 years (Vogel et al., 2005). The black spruce canopy is sparse. The average canopy height is about 3.5 m, but there are taller trees of up to 6 m, sporadically. Understory vegetation includes typical boreal forest shrubs, such as *Rhododendron groenlandicum*, *Vaccinium uliginosum*, *Vaccinium vitis-idaea*, and *Betula glandulosa*, as well as some *Carex* species. The forest floor is almost completely covered by mosses, such as *Sphagnum capillifolium*, *Sphagnum magellanicum*, *Sphagnum riparium*, *Calliergon stramineum*, *Aulacomnium palustre*, and patchy lichen, such as *Cladonia* species. Discontinuous permafrost is widely distributed 40 cm below the surface, and a thin, silty clay layer exists on the upper-most permafrost (Kim et al., 2007).

The sensor system was built on sphagnum and feather moss layers and was in operation from 6 October 2006 (DOY 280) to 30 April 2007 (DOY 485) for the monitoring of continuous CO<sub>2</sub> concentration in snowpack during the winter of 2006/2007 (Fig. 1). The non-dispersive infrared sensor (NDIR; Vaisala GMD 20; Helsinki, Finland) was set on a length of wooden stick (3 cm diameter, 100 cm long) at four directional levels (10, 20, 30, and 50 cm above the moss surface) for prevention of disturbance (Fig. 1). This sensor is the same type used for prior winter CO<sub>2</sub>-flux measurements (Hirano et al., 2003; Takagi et al., 2005). The installed sensor was covered with a PVC pipe (48 mm OD; 40 mm ID; 170 mm long), open on one end, for water and sensor-window protection. The NDIR-equipped sensor window is 50 mm long with a 4 mm-wide slit on the head, which measures soil CO<sub>2</sub> concentration through the snowpack. The cable from each sensor was connected to a datalogger (CR 1000, Campbell Scientific Inc., USA) within an ice cooler for the storage of CO<sub>2</sub> data. A commercial heating pad was used for operation of the logger during winter. CO<sub>2</sub> concentration measured at the 50 cm level above the surface is not discussed here due to unexpected failure of the sensor in the extremely cold weather.

The calibration of each sensor was conducted using certified EPA protocol for a CO<sub>2</sub> standard cylinder (1000.0 ppm; Airgas Inc., USA) and zero gas (pure N<sub>2</sub> cylinder; Airgas Inc., USA), before and after the monitoring of CO<sub>2</sub> concentration in the laboratory.

The sensor responded to the standard cylinder within 10 s, and repeatedly measured standard CO<sub>2</sub> concentration for 60 min. The precision on each sensor ranged from 0.6 to 4.5 %, and the CO<sub>2</sub> concentration of each sensor was corrected. The CO<sub>2</sub> concentration in the snowpack was calculated at 30 min intervals for each corrected sensor.

5 Temperatures in snow and soil were measured at 10, 20, 30, 40, 50, and 80 cm above, and at 5, 10, 15, 20, 30, 40, and 50 cm below the soil surface, and were monitored at a 1.5 h interval, with sensors (TMC6-HC, Onset Computer Corporation, USA) and 4 external channel-loggers (U-12 HOBO, Onset Computer Corporation, USA). Soil moisture was monitored at 5 and 20 cm below the surface at a 1.5 h interval using  
10 sensors (ML2x, Dynamax Inc, USA) and a 2-channel logger (THLOG-2, Dynamax Inc, USA). The monitoring of temperature and soil moisture was conducted from 12 September 2006 to 6 September 2007. Atmospheric pressure was recorded by barometer (CS100, Campbell Scientific Inc., USA) every 30 min at 8 m at the eddy-covariance tower site. The daily snow-depth data was taken from the Alaska Climate Research  
15 Center of the Geophysical Institute (GI) at the University of Alaska Fairbanks (UAF) during the winter of 2006/2007 (Alaska Climate Research Center, 2008: Fig. 2). Because the snow depth was much lower than in normal years, winter CO<sub>2</sub> flux was estimated between DOY 357 (23 December 2006) to 466 (11 April 2007), when the snow depth was higher than 25 cm at the lowest. While the snow depth was less than 20 cm before  
20 DOY 257, the winter flux could not be estimated. The accumulated snowpack began to melt on DOY 446 (21 March 2007). The snow survey was also conducted at a two-week interval. Two to five snow samples were collected using a snow density sampler (4 cm H × 5 cm W × 5 cm D) and a snow cutter for the estimation of snow porosity (Kim et al., 2007).

## 25 2.2 Estimation of winter CO<sub>2</sub> flux

The winter CO<sub>2</sub> flux through snowpack to the atmosphere was obtained by applying the following equation under a steady-state condition:  $F_{\text{CO}_2} = D \cdot (\partial C / \partial z) \cdot \tau \cdot \theta$  (Kim et al., 2007), where  $D$  is CO<sub>2</sub> diffusivity corrected only for the in-situ temperature within the

**BGD**

9, 1129–1159, 2012

### Environmental factors regulating winter CO<sub>2</sub> flux

Y. Kim and Y. Kodama

Title Page

Abstract

Introduction

Conclusions

References

Tables

Figures

◀

▶

◀

▶

Back

Close

Full Screen / Esc

Printer-friendly Version

Interactive Discussion



snowpack measured in  $\text{cm}^2 \text{sec}^{-1}$  (Sommerfeld et al., 1993; Fahnstock et al, 1999);  $\partial C/\partial z$  is the vertical  $\text{CO}_2$  concentration gradient observed within the snowpack in  $\text{ppmv cm}^{-1}$ ;  $\tau$  is tortuosity; and  $\theta$  is the snow porosity. The  $\text{CO}_2$  concentration gradients from 10 to 30 cm and from 20 to 30 cm were similar, indicating that the gradient is almost linear; the gradient ratios for the 10–30 cm and 20–30 cm ranges varied from 0.87 to 1.22. Porosity was calculated from the density of ice ( $\rho_{\text{ice}} = 0.91$ ) and the water contents of the snowpack over the gradient interval. Tortuosity is difficult to measure and is usually described as a function of porosity, with values ranging from  $\theta^{1/3}$  to  $\theta^{2/3}$  (Striegl, 1993). In this study, the tortuosity of the snowpack was estimated by the theoretical relation  $\tau = \theta^{1/3}$  (Millington, 1959), which yielded values ranging from 0.74 to 0.92. These values are similar to the range of 0.70 to 0.91 for the whole observation period for boreal forest snowpack in interior Alaska. Sommerfeld et al. (1993), Mast et al. (1998), and Kim et al. (2007) reported similar data (0.68 to 0.90) in subalpine snowpack in Wyoming and Colorado, and in boreal forest snowpack in Alaska.

### 2.3 Analysis of soil heat flux

We correlated winter  $\text{CO}_2$  flux with the non-conductive heat flux component of the active layer. The non-conductive heat component,  $r_h$ , is expressed in terms of volumetric heat production in  $\text{W/m}^2$  and is estimated by considering one-dimensional energy conservation as formulated:

$$r_h = c_h \frac{\partial T}{\partial t} - k_h \frac{\partial^2 T}{\partial z^2} \quad (1)$$

where  $c_h$  is the volumetric bulk heat capacity,  $k_h$  is bulk thermal conductivity,  $T$  is temperature,  $t$  is time, and  $z$  is depth. Neglecting energy exchange below the lowest measurement, the total amount of non-conductive heat components,  $R_h$ , is the result

**BGD**

9, 1129–1159, 2012

## Environmental factors regulating winter $\text{CO}_2$ flux

Y. Kim and Y. Kodama

Title Page

Abstract

Introduction

Conclusions

References

Tables

Figures

◀

▶

◀

▶

Back

Close

Full Screen / Esc

Printer-friendly Version

Interactive Discussion



of  $r_h$  multiplied by the thickness of the soil layer,  $d$ :

$$R_h = \sum_i r_h^i d^i \quad (2)$$

where the subscript  $i$  represents the  $i$ -th layer from surface to bottom. We set the mid-depth of the  $i$ -th layer to be at the  $i$ -th measurement depth from the surface. Accordingly, the soil column was divided into three layers, the thicknesses of which were 5, 7.5, and 10 cm from the surface to bottom (25 cm). Finite element formulations to solve equations (1) and (2) are described in Ishikawa et al. (2006).

We assumed  $k_h$  to range from  $5.5 \times 10^{-7}$  to  $8.0 \times 10^{-7}$  J/kg/K, referring to the thermal diffusivity for frozen silty clay shown by Yerшов (1998;  $d_h = 5.5 \times 10^{-7} - 8 \times 10^{-7} \text{ m}^2 \text{ s}^{-1}$ ) and to its heat capacity shown by Roth and Boike (2001;  $c_h = 2.2 \pm 0.2 \times 10^6 \text{ J/m}^3 \text{ K}$ ). These calculations neglected the contribution of soil air because of its very low mass density.

### 3 Results and discussion

During the winter, wind speed and direction have been important factors affecting winter  $\text{CO}_2$  fluxes in temperate and subalpine regions (Massman et al., 1997; Takagi et al., 2005; Massman and Frank, 2006). However, most (>85%) of the wind speed during winter at our location was less than  $1.0 \text{ m sec}^{-1}$ . Thus, winter  $\text{CO}_2$  flux as an effect of wind speed was not considered in our study. We used 6-h averages of  $\text{CO}_2$  concentration, winter  $\text{CO}_2$  flux, atmospheric pressure, temperatures in air and soil, and soil moisture, during the snow-covered period of 2006/2007.

#### 3.1 Environment factors and $\text{CO}_2$ concentration

Soil moisture and the temperatures at 80 cm above the soil surface and at 5 cm below the surface were monitored from DOY 255 to 614 (Fig. 3). Atmospheric temperature

**BGD**

9, 1129–1159, 2012

## Environmental factors regulating winter $\text{CO}_2$ flux

Y. Kim and Y. Kodama

Title Page

Abstract

Introduction

Conclusions

References

Tables

Figures

◀

▶

◀

▶

Back

Close

Full Screen / Esc

Printer-friendly Version

Interactive Discussion





**Environmental factors regulating winter CO<sub>2</sub> flux**

Y. Kim and Y. Kodama

Title Page

Abstract

Introduction

Conclusions

References

Tables

Figures

◀

▶

◀

▶

Back

Close

Full Screen / Esc

Printer-friendly Version

Interactive Discussion



showed a higher daily variation, and the temporal fluctuation of soil temperature was lower. Soil moisture at 5 cm below the surface was affected by low ( $<0^{\circ}\text{C}$ ) atmospheric temperature and soil freezing, and the freezing rate from 5 to 20 cm was  $0.75\text{ cm d}^{-1}$ , suggesting that the time it took the freezing front to reach 20 cm was 20 days. Kim et al. (2007) reported a freezing rate of  $4\text{ cm d}^{-1}$  for 10 to 30 cm below the surface during the winter of 2004/2005 in the same observation area. In our study, the frozen soils began to thaw at 5 cm by DOY 489 (4 May 2007), and at 20 cm by DOY 508 (22 May 2007); the melting rate over these 19 days was  $0.78\text{ cm d}^{-1}$ , similar to the freezing rate in early winter.

Ambient pressure and temperature ranged from 943 to 1020 hPa and from  $-45$  to  $17^{\circ}\text{C}$ , respectively, during the period of DOY 350 to 466. The temporal variation in pressure showed an inverse tendency to the change in temperature. Thus, in order to quantify the effects of pressure and temperature for winter CO<sub>2</sub> flux, the magnitude of pressure during the snow-covered period was divided into four phases: high pressure (HP:  $>1000\text{ hPa}$ ); intermediate pressure (IP:  $985\text{ hPa} < P < 1000\text{ hPa}$ ); low pressure (LP:  $<985\text{ hPa}$ ); and a snow-melting period (MP, after DOY 466); all shown in Fig. 2. Atmospheric temperature was  $-31.9 \pm 11.0^{\circ}\text{C}$  (Coefficient of Variance [CV]: 35%) for HP;  $-22.1 \pm 8.6^{\circ}\text{C}$  (CV: 39%) for IP;  $-21.5 \pm 6.8^{\circ}\text{C}$  for LP; and  $-8.4 \pm 12.4^{\circ}\text{C}$  (CV: 146%) for MP. These air pressure phases, then, correspond to the magnitude of air temperature.

Figure 4 shows the relationship between ambient temperature and temperatures in snow (10, 20, and 40 cm above the soil surface), and soil (5 cm below), in order to demonstrate additional influence on ambient temperature. The ambient temperature indicates correlation coefficients ( $R^2$ ) of 0.995, 0.99, and 0.79 for snow at 40, 20, and 10 cm above the surface, respectively, and 0.08 for soil 5 cm beneath the surface, suggesting that the extent of atmospheric temperature influence reached to 20 cm within the snowpack when the snow depth was less than 40 cm.

CO<sub>2</sub> concentrations at 10, 20, and 30 cm above the soil surface are shown with temporal variations in pressure in Fig. 5. The 6 h average CO<sub>2</sub> concentrations in

the snowpack were  $627 \pm 19$  ppm (CV: 3.0%) for 10 cm,  $532 \pm 18$  ppm (CV: 3.3%) for 20 cm, and  $473 \pm 32$  ppm (CV: 6.7%) for 30 cm. The concentration range of 365 to 692 ppm in sphagnum/feather moss regimes is comparable to the 400 to 740 ppm measured in tussock tundra/sphagnum moss regimes of boreal forest soils (Kim et al., 2007), during which tussock tundra was also found to be one of the carbon sources in boreal forest and Arctic terrestrial ecosystems of the Northern Hemisphere (Oechel et al., 1997; Kim et al., 2007). The temporal variations in CO<sub>2</sub> concentration showed a similar trend at 10, 20, and 30 cm levels, and may be affected by ambient pressure, as is the case in the relationship between pressure and ambient temperature.

### 3.2 Estimation of winter CO<sub>2</sub> flux

Winter CO<sub>2</sub> flux varied from 0.19 to 0.26 gCO<sub>2</sub>-C m<sup>-2</sup> d<sup>-1</sup> for the HP phase (>1000 hPa), from 0.19 to 0.27 gCO<sub>2</sub>-C m<sup>-2</sup> d<sup>-1</sup> for IP (985 < P < 1000), from 0.20 to 0.32 gCO<sub>2</sub>-C m<sup>-2</sup> d<sup>-1</sup> for LP (<985 hPa), and from 0.14 to 0.24 gCO<sub>2</sub>-C m<sup>-2</sup> d<sup>-1</sup> for MP. The average winter CO<sub>2</sub> flux and atmospheric temperature for the four pressure phases are shown in Table 1. Average winter CO<sub>2</sub> flux among the three pressure phases, excluding the snow-melting period, was not significantly different based on a one-way ANOVA with a 95 % confidence level. During the snow-covered period of 109 days, the average CO<sub>2</sub> flux was  $0.22 \pm 0.02$  gCO<sub>2</sub>-C m<sup>-2</sup> d<sup>-1</sup> (CV: 10%), indicating a value corresponding to those measured by concentration profile ( $0.21 \pm 0.06$  gCO<sub>2</sub>-C m<sup>-2</sup> d<sup>-1</sup>) and chamber ( $0.26 \pm 0.06$  gCO<sub>2</sub>-C m<sup>-2</sup> d<sup>-1</sup>) methods during the winter of 2004/2005 in the same black spruce forest soils of interior Alaska (Kim et al., 2007). Furthermore, the snow depth in the winter of 2004/2005 was much deeper (>20 cm) than 2006/2007. Although the snow depth was greater, the minimum soil temperature at 5 cm below the surface was -17 °C, due to an extremely cold ambient temperature of -55 °C (12 January 2005). This suggests that the greater snow depth (68 cm) plays little role in insulating the soil below -50 °C. In the temperate forests and grassland soils of northern Japan, greater snow depth (>80 cm) has kept soil at 5 cm beneath the surface warmer

**Environmental factors regulating winter CO<sub>2</sub> flux**

Y. Kim and Y. Kodama

Title Page

Abstract

Introduction

Conclusions

References

Tables

Figures

◀

▶

◀

▶

Back

Close

Full Screen / Esc

Printer-friendly Version

Interactive Discussion



than zero (Takagi et al., 2005), and an increase in snow depth (35 to 70 cm) caused a temperature jump from  $-0.42$  to  $0.15^{\circ}\text{C}$  at a 5 cm soil depth (Kim and Tanaka, 2002). This kind of change in soil temperature modulates the magnitude of soil  $\text{CO}_2$  production by affecting soil microbial activity in tundra soils during the winter (Oechel et al., 1997; Panikov et al., 2006).

Temporal variations in pressure and ambient temperature for winter  $\text{CO}_2$  flux are shown in Fig. 6. The temporal variation of winter  $\text{CO}_2$  flux shows a tendency that is qualitatively inverse to that of pressure (Fig. 6a) but is similar to that of ambient temperature (Fig. 6b). The winter  $\text{CO}_2$  flux abruptly decreased from  $0.28$  to  $0.17 \text{ gCO}_2\text{-C m}^{-2} \text{ d}^{-1}$  by DOY 446 (21 March 2007), which was the first day of snow melting – when ambient temperature increased to above zero, as shown in Fig. 3. Also, the temperature dropped from  $1.23$  to  $-13.8^{\circ}\text{C}$ , and the pressure increased from  $959$  to  $980 \text{ hPa}$ . Therefore, the atmospheric temperature, modulated by the pressure, is a significant factor in determining winter  $\text{CO}_2$  flux in the seasonally snow-covered boreal forest soil of interior Alaska.

### 3.3 Environmental factors regulating winter $\text{CO}_2$ flux

Winter  $\text{CO}_2$  flux has a direct relationship to atmospheric pressure for HP ( $>1000 \text{ hPa}$ ), LP ( $<985 \text{ hPa}$ ), and MP (snow-melting) days of the snow-covered period (Fig. 7a), indicating an inverse correlation for each pressure phase. The data for the IP ( $985 < P < 1000$ ) phase is virtually excluded in Fig. 7a – the temperatures in air and soil during IP are discussed below. The correlation coefficients ( $R^2$ ) were  $0.25$  for HP,  $0.31$  for LP, and  $0.18$  for MP. Ambient pressure has a lesser effect in determining winter  $\text{CO}_2$  flux through the snowpack to the atmosphere during the winter season.

Winter  $\text{CO}_2$  flux shows a strong exponential relationship to ambient temperature, though, for three pressure phases: the correlation coefficients were  $0.80$  at low temperature for HP,  $0.26$  at high temperature for LP, and  $0.58$  for MP (Fig. 7b). The regression curves in Fig. 7b are  $Y = 0.27e^{(0.0697T)}$  for HP,  $Y = 0.29e^{(0.0077T)}$  for LP, and

**BGD**

9, 1129–1159, 2012

## Environmental factors regulating winter $\text{CO}_2$ flux

Y. Kim and Y. Kodama

Title Page

Abstract

Introduction

Conclusions

References

Tables

Figures

◀

▶

◀

▶

Back

Close

Full Screen / Esc

Printer-friendly Version

Interactive Discussion



$Y = 0.18e^{(0.065T)}$  for MP. Figure 7c shows the relationship between CO<sub>2</sub> flux and ambient temperature for IP (985 < *P* < 1000), which also has strong correlation, suggesting that the air temperature accounted for 58 % of the variability of winter CO<sub>2</sub> emission during IP, with a regression curve of  $Y = 0.27e^{(0.064T)}$ . During the LP phase, the coefficient was less than half the coefficient in either HP, MP, or IP. Winter CO<sub>2</sub> flux during the early days of the snow-covered period was much higher than during the remainder of this period. This may be due to a higher concentration difference between the 10- and 20 cm levels before DOY 368, when the snow depth was less than 27 cm. As a result, we calculated the 6 h average CO<sub>2</sub> concentration gradient before and after DOY 368; the difference in CO<sub>2</sub> flux is likely due in part to warm soil temperature before DOY 368. The soil temperature is dependent on the snow depth and affects the soil microbial physiology and the community composition (Brooks et al., 1996; Oechel et al., 1997; Kim and Tanaka, 2002; Takagi et al., 2005; Monson et al., 2006).

The  $Q_{10}$  is the temperature coefficient of the reaction and is defined as the ratio of reaction rate at an interval of 10 °C. Our  $Q_{10}$  values were 1.22 for HP, 1.25 for LP, 1.26 for MP, and 1.37 for IP. These values are much lower than those of previous studies during the winter (Oechel et al., 1997; Monson et al., 2006). Monson et al. (2005) reported the  $R_T$  (a first-order exponential coefficient analogous to the  $Q_{10}$  coefficient used in biochemical studies) was 105 near trees and  $1.25 \times 10^6$  in the open space of the LTER Niwot Ridge Ameriflux site. These values are several orders of magnitude higher than the range of  $Q_{10}$  values found in previous studies of terrestrial ecosystem soils, demonstrating that higher temperature sensitivity invokes a physical limitation to substrate diffusion—as liquid water disappears below zero (between 0 and -1 °C). Panikov et al. (2006) proved that soil CO<sub>2</sub> production occurred even under the extremely cold soil temperature of -39 °C, with soil core samples (0–30 cm) from Barrow, Siberia, and Sweden; their  $Q_{10}$  values ranged from 2.1 to 8.5.

Estimated soil non-conductive heat flux evolved negatively through the period from DOY 357 to 460, for both upper and lower  $d_h$  and  $c_h$  (Fig. 8a). Assuming that this heat arises from a single phase transition of water, we compared soil moisture

**BGD**

9, 1129–1159, 2012

## Environmental factors regulating winter CO<sub>2</sub> flux

Y. Kim and Y. Kodama

Title Page

Abstract

Introduction

Conclusions

References

Tables

Figures

◀

▶

◀

▶

Back

Close

Full Screen / Esc

Printer-friendly Version

Interactive Discussion



observed, using  $R_h$  divided by the enthalpy of the transition from phases  $\alpha$  to  $\beta$ ,  $L^{\sigma\beta}$  ( $\{L^{sl}, L^{lv}\} = \{0.333, 2.45\} \text{ MJ kg}^{-1}$ , where the superscript s, l and v represent solid, liquid, and vapor, respectively), and found that this heat was mostly from vaporization. As shown in Fig. 8a, winter  $\text{CO}_2$  flux showed a decreasing trend until the end of the snow-covered period, while latent heat flux showed an increasing trend. Also, both fluxes showed significant correlations ( $R^2 = 0.49$  and  $0.52$ , with  $p < 0.001$  in both) before the onset of snow melting (Fig. 9). These findings suggest that the higher upward vapor movement in the soil column occurred in accordance with the smaller, soil-originated  $\text{CO}_2$  flux. We postulate that winter soil-originated  $\text{CO}_2$  is hampered by the reduction of snow pores linked to the atmosphere – due to compaction of the snowpack, vapor condensation in the snow column, and subsequent snow metamorphism. This consideration is supported by the comparison between  $\text{CO}_2$  flux and the snow temperature gradient (Fig. 8b). Winter  $\text{CO}_2$  flux was occasionally greater when the snow temperature profile approached the isotherm and the condensation rate was reduced (e.g. DOY 364, 368, 392–399, 406, 411, 423, 434; Fig. 8a and b). The temperature gradient governed the vapor pressure gradient through the snow and soil column, modulating evaporation, condensation, and vapor movements. This modified the passage of winter  $\text{CO}_2$ .

Figure 10 shows the correlation coefficient percentages (%) for atmospheric pressure, temperature, soil temperature, and winter  $\text{CO}_2$  flux during each pressure phase. During HP, IP, and MP, the strongest environmental factors determining winter  $\text{CO}_2$  flux were atmospheric temperature, soil temperature, and atmospheric pressure, respectively. Takagi et al. (2005) implied that winter  $\text{CO}_2$  flux responded directly to ambient temperature, and not to soil temperature, even beneath a 1 m snowpack of temperate forest soils in Japan. They inferred that the atmospheric temperature affected the root activity of trees through their trunks and that the variation in root respiration strongly affected fluctuation in  $\text{CO}_2$  concentration in soil under the snowpack. Vogel et al. (2005) suggested that the contribution of root respiration in mature black spruce forest soils varied from 81–85 % of total soil respiration during the winter. Moreover, because their

**BGD**

9, 1129–1159, 2012

**Environmental factors regulating winter  $\text{CO}_2$  flux**

Y. Kim and Y. Kodama

Title Page

Abstract

Introduction

Conclusions

References

Tables

Figures

◀

▶

◀

▶

Back

Close

Full Screen / Esc

Printer-friendly Version

Interactive Discussion



site is similar to the study site here, Kim et al. (2007) demonstrated that the  $\delta^{13}\text{CO}_2$  of  $-22.5\%$  originated from root respiration rather than heterotrophic respiration in black spruce forest soils of interior Alaska during the winter. Atmospheric temperature and soil temperature at 5 cm, depending on ambient pressure, therefore, play significant and key factors in regulating winter  $\text{CO}_2$  emission through the snowpack in these forest soils during the snow-covered period.

### 3.4 Implication for regional winter carbon budget

Average wintertime  $\text{CO}_2$  emission was  $24.3 \pm 1.3 \text{ gCO}_2\text{-C m}^{-2}/\text{season}$  (CV: 5%) during the snow-covered period of 109 days. For our four pressure phases, average emissions are shown in Table 2. The cumulative snow depth in 2006/2007 was one of the lowest years in Fairbanks over the past 80 years – the snow depth during the 212-day winter period of 2006/2007 corresponds to merely half of a normal season. However, winter  $\text{CO}_2$  emission has always occurred before DOY 357 and after DOY 466. Thus, winter  $\text{CO}_2$  emission was reevaluated as a half of the average flux ( $0.23 \pm 0.02 \text{ gCO}_2\text{-C m}^{-2} \text{ d}^{-1}$ ) measured before DOY 357 (23 December 2006), and as a half of the flux ( $0.17 \pm 0.02 \text{ gCO}_2\text{-C m}^{-2} \text{ d}^{-1}$ ) measured after DOY 466 (21 March 2007). The wintertime  $\text{CO}_2$  emission was  $36 \pm 1.7 \text{ gCO}_2\text{-C m}^{-2}/\text{season}$  (CV: 5%) during the winter of 2006/2007. This emission corresponds to 20% of the annual  $\text{CO}_2$  emitted from boreal black forest soils in interior Alaska; the  $\text{CO}_2$  emission was  $142 \pm 57 \text{ gCO}_2\text{-C m}^{-2}/\text{season}$  (CV: 40%) in the same study site during the growing period of 2006. Kim et al. (2007) reported that the wintertime  $\text{CO}_2$  emission was  $49 \pm 13 \text{ gCO}_2\text{-C m}^{-2}/\text{season}$  in the same boreal forest during the winter of 2004/2005, a difference due to a longer snow-covered period and greater snow depth than in this study. Also in the boreal forest of interior Alaska, Vogel et al. (2005) measured a winter respiration of 36–54  $\text{gCO}_2\text{-C m}^{-2}/\text{season}$  in three different tree ages (75, 110, and 120 years) of black spruce forests of Bonanza Creek, interior Alaska, representing 8–18% of the annual  $\text{CO}_2$  emission. Further, the winter respiration was

**Environmental factors regulating winter  $\text{CO}_2$  flux**

Y. Kim and Y. Kodama

Title Page

Abstract

Introduction

Conclusions

References

Tables

Figures

◀

▶

◀

▶

Back

Close

Full Screen / Esc

Printer-friendly Version

Interactive Discussion



## Environmental factors regulating winter CO<sub>2</sub> flux

Y. Kim and Y. Kodama

Title Page

Abstract

Introduction

Conclusions

References

Tables

Figures

◀

▶

◀

▶

Back

Close

Full Screen / Esc

Printer-friendly Version

Interactive Discussion



40–55 gCO<sub>2</sub>-C m<sup>-2</sup>/season in black spruce and jack pine forests of the BOREAS study area (Winston et al., 1997) and later 25–35 gCO<sub>2</sub>-C m<sup>-2</sup>/season in the black spruce forest of the BOREAS area (Wang et al., 2003), in which the winter carbon contributions accounted for 5–19% of the annual respiration. The BOREAS study area contained one south-facing and one north-facing vegetation distribution, resulting in a difference of soil drainage that greatly affects the species composition and functions of the boreal forest ecosystem (Wang et al., 2003). The magnitude of soil drainage regulates the decomposition rate of soil organic carbon and the vegetation biophysical conditions.

In snow-covered Arctic tundra ecosystems of the North Slope of Alaska, the winter CO<sub>2</sub> emissions from moist tussock tundra and coastal wet sedge were 70 and 20 gCO<sub>2</sub>-C m<sup>-2</sup>/season, respectively (Oechel et al., 1997). That is the main share of the total annual net carbon emission in Arctic tundra ecosystems. In the same Arctic tundra ecosystems, winter CO<sub>2</sub> emission ranged from 1.3 to 11 gCO<sub>2</sub>-C m<sup>-2</sup>/season (Fahnestock et al., 1998), depending on the vegetation community types, flux that represents up to 17% of the annual carbon flux of Arctic tundra ecosystems.

Considering all the snow-covered tussock and moss regimes in the Northern Hemisphere (6.5 × 10<sup>12</sup> m<sup>2</sup>; Whalen and Reeburgh, 1998), winter carbon emission should not be overlooked when estimating regional and global carbon budgets. Furthermore, regional/global process-based CO<sub>2</sub> cycle models should be sufficiently discussed and modified to include winter CO<sub>2</sub> contribution, considering atmospheric temperature as a key regulating factor and depending on atmospheric pressure, in snow-covered soils of Arctic and sub-Arctic terrestrial ecosystems in the Northern Hemisphere.

## 4 Conclusions

The continuous monitoring of winter CO<sub>2</sub> flux in snowpack was conducted in sphagnum and feather moss regimes of black spruce forest soils of interior Alaska during the winter of 2006/2007. Measurements were taken of key environmental factors that regulate winter CO<sub>2</sub> flux, such as atmospheric pressure and temperatures in air and

soil, during the snow-covered period from DOY 357 (23 December 2006) to 466 (11 March 2007). Atmospheric pressure was divided into four phases: >1000 hPa (HP: high pressure), <986 hPa (LP: low pressure),  $985 < P < 1000$  (IP: intermediate pressure), and the snow-melting period (MP), for the quantification of the effect of atmospheric pressure on temperature-modulated winter CO<sub>2</sub> flux. Winter flux greatly depends on atmospheric temperature, which is governed by these four pressure phases. Pressure is an important factor in indirectly and directly influencing atmospheric temperature and winter CO<sub>2</sub> flux. The transport of CO<sub>2</sub> emissions through soil and snow columns is modified by snow compaction and metamorphism and is modulated by evaporation, condensation, and vapor movements through the columns. Moreover, atmospheric temperature and soil temperature play significant roles in determining winter CO<sub>2</sub> flux, demonstrated by the fact that atmospheric temperature accounted for an average of 56 % of the variability of winter CO<sub>2</sub> emission during the snow-covered period. Because snow-covered tussock and moss regimes are widely distributed in Northern Hemisphere, wintertime carbon emission is of considerable significance when estimating seasonal, regional and global carbon budgets, as this emission represented 20 % of the annual soil carbon emissions in black spruce forest soils in interior Alaska during the cold winter of 2006/2007. Regional/global process-based CO<sub>2</sub> cycle models should be reassessed to consider the effect that atmospheric temperature and soil latent-heat flux have in regulating winter CO<sub>2</sub> emissions in snow-covered soils of Arctic and sub-Arctic terrestrial ecosystems in the Northern Hemisphere.

*Acknowledgements.* This study was jointly funded by the Japan Agency for Marine-Earth Science and Technology (JAMSTEC), the Japan Aerospace Expedition Agency (JAXA) as an IARC-JAXA Information System (IJIS) project, and partly supported by the Korea Ministry of Environment as “The Eco-technopia 21 project”. We thank Y. Harazono and M. Ueyama of the International Arctic Research Center (IARC) at the University of Alaska Fairbanks for providing air pressure data; S. Nakatsubo of the Institute of Low Temperature Science (ILTS) and M. Ishikawa of the Graduate School of Environmental Earth Science, Hokkaido University, Japan for the management of instruments and analysis of soil heat flux; and L. Hinzman of IARC for his funding support and encouragement on this study.

**Environmental factors regulating winter CO<sub>2</sub> flux**

Y. Kim and Y. Kodama

Title Page

Abstract

Introduction

Conclusions

References

Tables

Figures

◀

▶

◀

▶

Back

Close

Full Screen / Esc

Printer-friendly Version

Interactive Discussion





## References

Alaska Climate Research Center: <http://climate.gi.alaska.edu/>, 2008.

Brooks, P. D., Williams, M. W., and Schmid, S. K.: Microbial activity under alpine snowpacks, Niwot Ridge, Colorado, *Biogeochemistry*, 32, 93–113, 1996.

5 Fahnestock, J. T., Jones, M. H., Brooks, P. D., Walker, D. A., and Welker, J. M.: Winter and early spring CO<sub>2</sub> efflux from tundra communities of northern Alaska, *J. Geophys. Res.*, 103, D22, 29023–29027, 1998.

Fahnestock, J. T., Jones, M. H., and Welker, J. M.: Wintertime CO<sub>2</sub> efflux from Arctic soils: Implications for annual carbon budgets, *Global Biogeochem. Cy.*, 13, 3, 775–779, 1999.

10 Hirano, T.: Seasonal and diurnal variations in topsoil and subsoil respiration under snowpack in a temperate deciduous forest, *Global Biogeochem. Cy.*, 19, GB2011, doi:10.1029/2004GB002259, 2005.

Ishikawa, M., Zhang, Y., Kadota, T., and Ohata, T.: Hydrothermal regimes of the dry active layer, *Water Resour. Res.*, 42, W04401, doi:10.1029/2005WR004200, 2006.

15 Ito, A. and Oikawa, T.: A simulated model of the carbon cycle in land ecosystems (Sim-CYCLE): A description based on dry matter theory and plot-scale validation, *Ecol. Model.*, 151, 143–176, 2002.

Kim, Y. and Tanaka, N.: Winter N<sub>2</sub>O emission rate and its production rate in soil underlying the snowpack in a subboreal region, Japan, *J. Geophys. Res.*, 107, D19, 4406, doi:10.1029/2001JD000833, 2002.

20 Kim, Y., Ueyama, M., Nakagawa, F., Tsunogai, U., Tanaka, N., and Harazono, Y.: Assessment of winter fluxes of CO<sub>2</sub> and CH<sub>4</sub> in boreal forest soils of central Alaska estimated by the profile method and the chamber method: A diagnosis of methane emission and implications for the regional carbon budget, *Tellus*, 59B, 223–233, 2007.

25 Kimball, J. S., Thornton, P. E., White, M. A., and Running, S. W.: Simulating forest productivity and surface-atmosphere carbon exchange in the BOREAS study region, *Tree Physiol.*, 17, 589–599, 1997.

Lagergren, F., Grelle, A., Lankreijer, H., Mölder, M., and Lindroth, A.: Current carbon balance of the forested area in Sweden and its sensitivity to global carbon change as simulated by Biome-BGC, *Ecosystems*, 9, 894–908, 2006.

30 Massman, W. J. and Frank, J. M.: Advective transport of CO<sub>2</sub> in permeable media induced by atmospheric pressure fluctuations: 2. Observational evidence under snowpacks, *J. Geophys.*

**BGD**

9, 1129–1159, 2012

---

### Environmental factors regulating winter CO<sub>2</sub> flux

Y. Kim and Y. Kodama

---

Title Page

Abstract

Introduction

Conclusions

References

Tables

Figures

◀

▶

◀

▶

Back

Close

Full Screen / Esc

Printer-friendly Version

Interactive Discussion



## Environmental factors regulating winter CO<sub>2</sub> flux

Y. Kim and Y. Kodama

Title Page

Abstract

Introduction

Conclusions

References

Tables

Figures

◀

▶

◀

▶

Back

Close

Full Screen / Esc

Printer-friendly Version

Interactive Discussion



Res., 111, G03005, doi:10.1029/2006JG000164, 2006.

Massman, W. J., Sommerfeld, R. A., Mosier, A. R., Zeller, K. F., Hehn, T. J., and Rochelle, S. G.: A model investigation of turbulence-driven pressure-pumping effects on the rate of diffusion of CO<sub>2</sub>, N<sub>2</sub>O, and CH<sub>4</sub> through layered snowpack, *J. Geophys. Res.*, 102, 18851–18863, 1997.

Mast, M. A., Wickland, K. P., Striegl, R. T., and Clow, D. W.: Winter fluxes of CO<sub>2</sub> and CH<sub>4</sub> from subalpine soils in Rocky Mountain National Park, Colorado, *Global Biogeochem. Cy.*, 12, 607–620, 1998.

McGuire, A. D., Clein, J. S., Melillo, J. M., Kicklighter, D. W., Meier, R. A., Vorosmaty, C. J., and Serreze, M. C.: Modelling carbon responses of tundra ecosystems to historical and projected climate: Sensitivity of pan-Arctic carbon storage to temporal and spatial variation in climate, *Glob. Change Biol.*, 6, 141–159, 2000.

Millington, R. J.: Gas diffusion in porous media, *Science*, 130, 100–102, 1959.

Monson, R. K., Lipsom, D. L., Burns, S. P., Turipseed, A. A., Delany, A. C., Williams, M. W., and Schmidy, S. K.: Winter forest soil respiration controlled by climate and microbial community composition, *Nature*, 439, 9, doi:10.1038/nature04555, 711–714, 2006.

Oechel, W. C., Vourlitis, G., and Hastings, J.: Cold season CO<sub>2</sub> emission from Arctic soils, *Global Biogeochem. Cy.*, 11, 163–172, 1997.

Panikov, N. S., Flanagan, P. W., Oechel, W. C., Mastepanov, M. A., and Christensen, T. R.: Microbial activity in soils frozen to below -39°C, *Soil Biol. Biochem.*, 38, 785–794, 2006.

Roth, K. and Boike, J.: Quantifying thermal dynamics of a permafrost site near Ny-Ålesund, Svalbard, *Water Resour. Res.*, 37, 2901–2914, 2001.

Running, S. W. and Coughlan, J. C.: A general model of forest ecosystem processes for regional applications I. Hydrologic balance, canopy gas exchange and primary production processes, *Ecol. Model.*, 42, 125–154, 1988.

Solomon, D. K. and Cerling, T. E.: The annual carbon dioxide in a montane soil: Observations, modeling, and implications for weathering, *Water Resour. Res.*, 23, 2257–2265, 1987.

Sommerfeld, R. A., Mosier, A. R., and Musselman, R. C.: CO<sub>2</sub>, CH<sub>4</sub> and N<sub>2</sub>O flux through a Wyoming snowpack and implications for global budgets, *Nature*, 361, 140–142, 1993.

Striegl, R. G.: Diffusional limits to the consumption of atmospheric methane by soils, *Chemosphere*, 26, 715–720, 1993.

Shulski, M. and Wendler, G.: The climate of Alaska, University of Alaska Fairbanks Press, Fairbanks, 216, 2007.

## Environmental factors regulating winter CO<sub>2</sub> flux

Y. Kim and Y. Kodama

Title Page

Abstract

Introduction

Conclusions

References

Tables

Figures

◀

▶

◀

▶

Back

Close

Full Screen / Esc

Printer-friendly Version

Interactive Discussion



- Takagi, K., Nomura, M., Ashiya, D., Takahashi, H., Sasa, K., Fujinuma, Y., Shibata, H., Akibayashi, Y., and Koike, T.: Dynamic carbon dioxide exchange through snowpack by wind-driven mass transfer in a conifer-broadleaf mixed forest in northernmost Japan, *Global Biogeochem. Cycles*, 19, GB2012, doi:10.1029/2004GB002272, 2005.
- 5 Vogel, J. G., Valentine, D. W., and Ruess, R. W.: Soil and root respiration in mature Alaska black spruce forests that vary in soil organic matter decomposition rates, *Can. J. For. Res.*, 35, 161–174, 2005.
- Wang, C., Bond-Lamberty, B., and Gower, S. T.: Soil surface CO<sub>2</sub> flux in a boreal black spruce fire chronosequence, *J. Geophys. Res.*, 108, D3, 8224, doi:10.1029/2001JD000861, 2003.
- 10 Wickland, K. P., Strigel, R. G., Mast, M. A., and Clow, D. W.: Carbon gas exchange at a southern Rocky Mountain wetland, 1996-1998, *Global Biogeochem. Cy.*, 15, 321–335, 2001.
- Winston, G. C., Sundquist, E. T., Stephens, B. B., and Trumbore, S. E.: Winter CO<sub>2</sub> fluxes in a boreal forest, *J. Geophys. Res.*, 102, 28795–28804, 1997.
- Yershov, E. D.: *General Geocryology*, Cambridge Univ. Press, New York, 580, 1998.
- 15 Zimov, S. A., Zimova, G. M., Daviodov, S. P., Daviodova, A. I., Voropaev, Y. V., Voropaeva, Z. V., Prosiannikov, S. F., Prosiannikova, O. V., Semiletova, I. V., and Semiletov, I. P.: Winter biotic activity and production of CO<sub>2</sub> in Siberian soils: A factor in the greenhouse effect, *J. Geophys. Res.*, 98, 5017–5023, 1993.
- Zimov, S. A., Daviodov, S. P., Voropaev, Y. V., Prosiannikov, S. F., Semiletov, I. P., Chapin, M. C., and Chapin, F. S.: Siberian CO<sub>2</sub> efflux in winter as a CO<sub>2</sub> source and cause of seasonality in atmospheric CO<sub>2</sub>, *Climate Change*, 33, 111–120, 1996.
- 20

**Environmental factors regulating winter CO<sub>2</sub> flux**

Y. Kim and Y. Kodama

Title Page

Abstract Introduction

Conclusions References

Tables Figures

◀ ▶

◀ ▶

Back Close

Full Screen / Esc

Printer-friendly Version

Interactive Discussion

**Table 1.** The 6 h averaged air temperature and winter CO<sub>2</sub> fluxes under four phases on air pressure during the snow-covered period of 2007 (DOY 357 to 466)

Pressure (hPa)		Observation	Air Temperature (°C)			Winter CO <sub>2</sub> Flux (gCO <sub>2</sub> -C m <sup>-2</sup> d <sup>-1</sup> )		
Phase	Sign	Number	Mean	Stdev	CV (%)	Mean	Stdev	CV (%)
>1000	HP	116	-31.9	11.0	35	0.22	0.02	9
985 < P < 1000	IP	7132	-22.1	8.6	39	0.23	0.02	7
<985	LP	108	-21.5	6.8	31	0.25	0.03	12
Snow-melting*	MP	80	-8.4	12.4	146	0.17	0.02	11
Average		436**	-21.0	9.7	46	0.22	0.02	10

Stdev and CV denote standard deviation and coefficient of variance.

\* Snow-melting began at DOY 446 (21 March 2008).

\*\* The observation number is in total.



Discussion Paper | Discussion Paper | Discussion Paper | Discussion Paper | Discussion Paper

## Environmental factors regulating winter CO<sub>2</sub> flux

Y. Kim and Y. Kodama

**Table 2.** Winter CO<sub>2</sub> Emissions during the snow-cover period of 2006/2007

Pressure (hPa)	Observation Days	Winter CO <sub>2</sub> Emission (gCO <sub>2</sub> -C m <sup>-2</sup> )		
		Mean	Stdev	CV (%)
HP	29	6.64	0.58	9
IP	33	7.36	0.64	7
LP	27	6.84	0.82	12
MP	20	3.50	0.39	11
Total	109	24.3	1.25	5

Stdev and CV denote standard deviation and coefficient of variance.

Title Page

Abstract

Introduction

Conclusions

References

Tables

Figures

◀

▶

◀

▶

Back

Close

Full Screen / Esc

Printer-friendly Version

Interactive Discussion



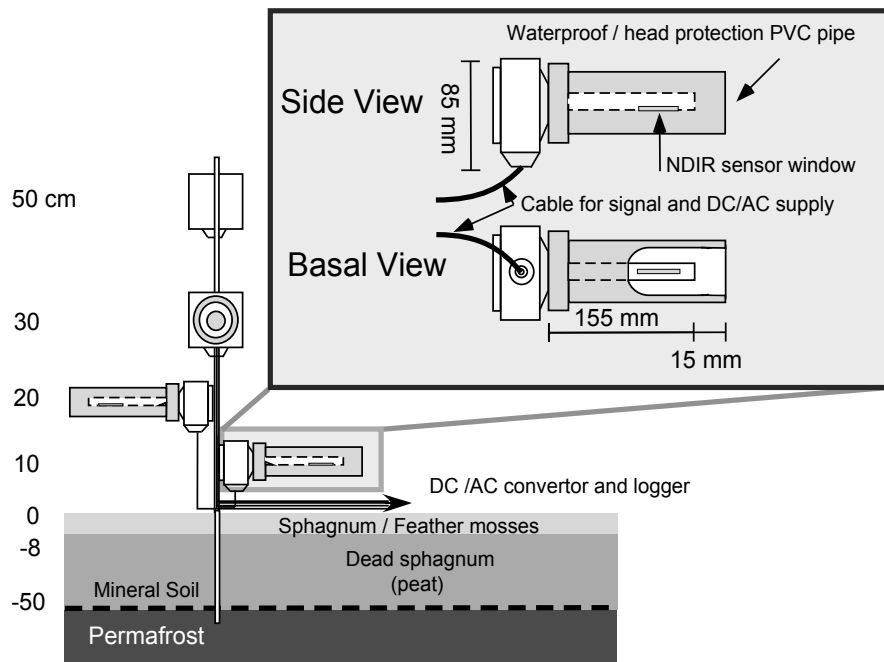

**Fig. 1.** Sampling scheme of observation system in sphagnum and feather moss regimes of black spruce forest, interior Alaska during the winter of 2006/2007.

**Environmental factors regulating winter CO<sub>2</sub> flux**

Y. Kim and Y. Kodama

Title Page

Abstract

Introduction

Conclusions

References

Tables

Figures

◀

▶

◀

▶

Back

Close

Full Screen / Esc

Printer-friendly Version

Interactive Discussion



Discussion Paper | Discussion Paper | Discussion Paper | Discussion Paper | Discussion Paper

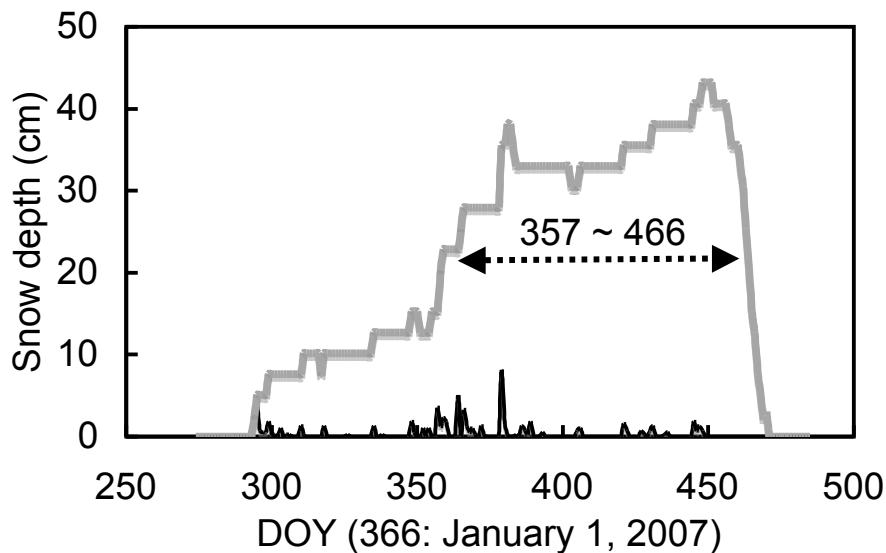

**Fig. 2.** Daily snowfall (black line) and cumulative snowpack (grey line) during the snow-covered period of DOY 357 (23 December 2006) to 466 (11 April 2007). Winter CO<sub>2</sub> flux is estimated when the snow depth is over 30 cm, due to the sensor levels.

**Environmental factors regulating winter CO<sub>2</sub> flux**

Y. Kim and Y. Kodama

Title Page

Abstract

Introduction

Conclusions

References

Tables

Figures

◀

▶

◀

▶

Back

Close

Full Screen / Esc

Printer-friendly Version

Interactive Discussion



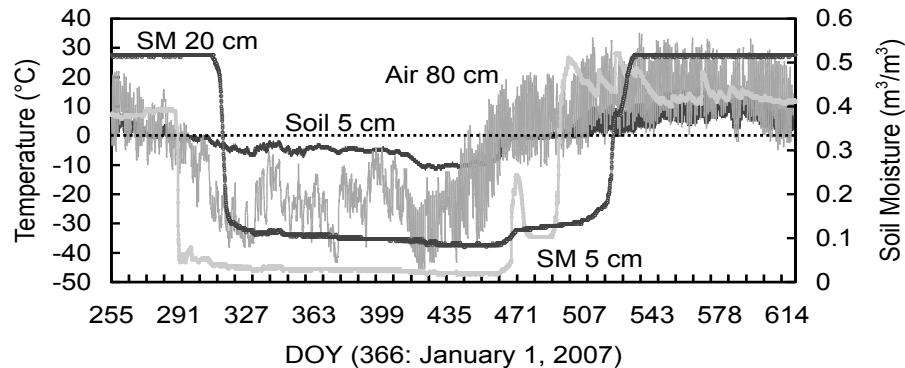

**Fig. 3.** Seasonal variations of 6 h average temperatures at air 80 cm above (grey line) and 5 cm below (black line) soil surface, and soil moistures at 5 cm (grey circles) and 20 cm (black circles) below surface from 12 August 2006 (DOY 254) to 10 September 2007 (DOY 618).

**Environmental factors regulating winter CO<sub>2</sub> flux**

Y. Kim and Y. Kodama

Title Page

Abstract Introduction

Conclusions References

Tables Figures

◀ ▶

◀ ▶

Back Close

Full Screen / Esc

Printer-friendly Version

Interactive Discussion





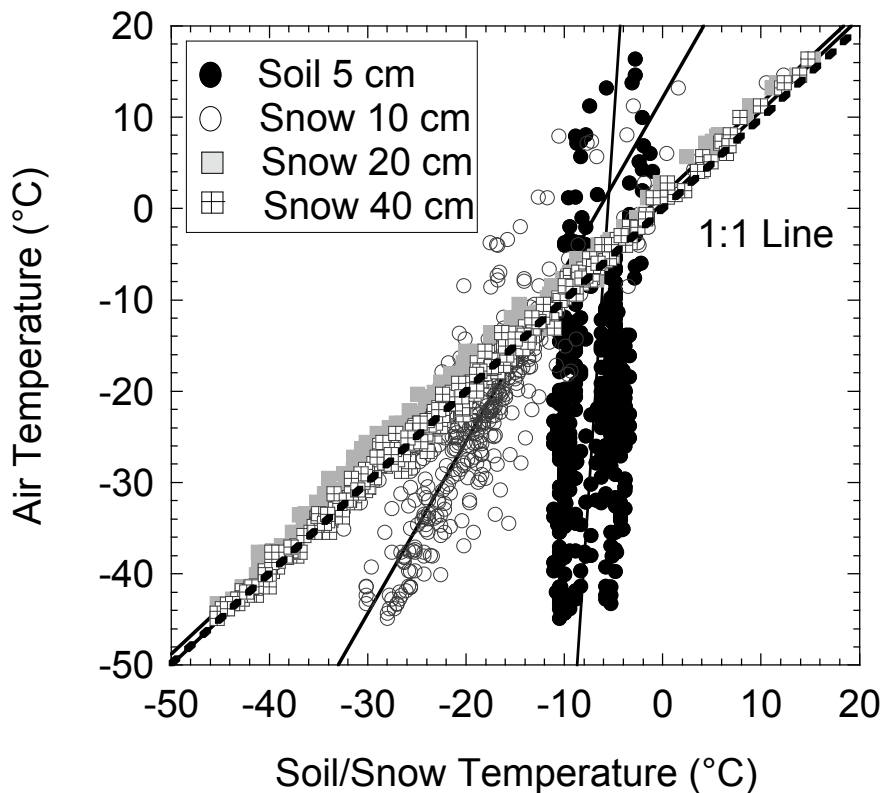

**Fig. 4.** Relationship between ambient temperature and temperatures of soil (5 cm below surface) and snow (10, 20, and 40 cm above surface) from DOY 254 to 618. When the snow depth was over 20 cm, the snow temperatures at 20 and 40 cm above the soil surface depend on the ambient temperature. The symbols indicate solid circles for soil at 5 cm below the surface, open grey circles for snow at 10 cm above, grey squares for snow at 20 cm above, and crossed squares for snow at 40 cm above, respectively. The dotted line is a 1:1 line.

**Environmental factors regulating winter CO<sub>2</sub> flux**

Y. Kim and Y. Kodama

Title Page

Abstract Introduction

Conclusions References

Tables Figures

◀ ▶

◀ ▶

Back Close

Full Screen / Esc

Printer-friendly Version

Interactive Discussion



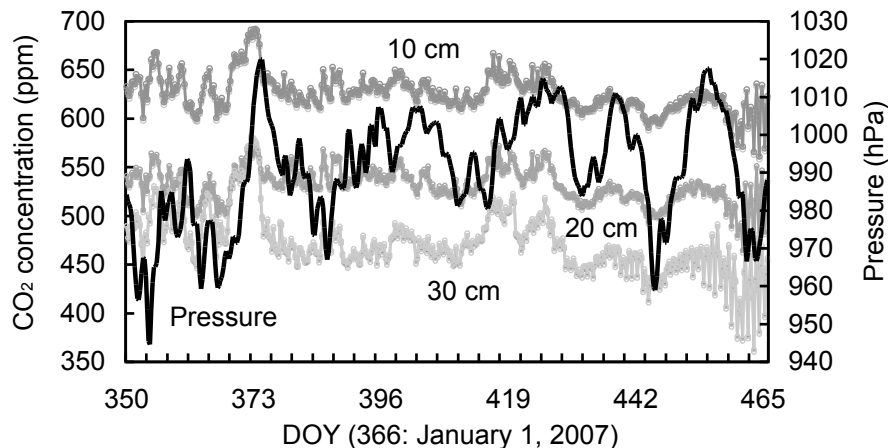

**Fig. 5.** Time series of CO<sub>2</sub> concentrations at 10, 20, and 30 cm above the soil surface within the snowpack, with seasonal change in atmospheric pressure. The concentration data was comparable with measurements from 392 to 742 ppm during the winter of 2004/2005 (Kim et al., 2007).

**Environmental factors regulating winter CO<sub>2</sub> flux**

Y. Kim and Y. Kodama

Title Page

Abstract

Introduction

Conclusions

References

Tables

Figures

◀

▶

◀

▶

Back

Close

Full Screen / Esc

Printer-friendly Version

Interactive Discussion



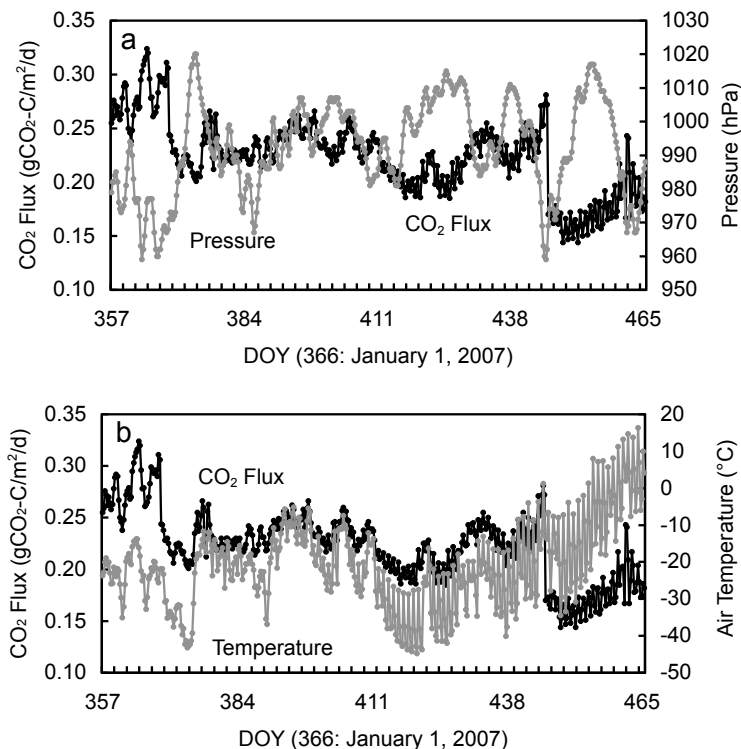

**Fig. 6.** Temporal variations of winter CO<sub>2</sub> flux along with (a) atmospheric pressure and (b) ambient temperature. Atmospheric pressure affects temperature, which regulates the magnitude of winter CO<sub>2</sub> flux. Thus, the pressure is divided into four phases: high pressure (HP: >1000 hPa), low pressure (LP: <985 hPa), intermediate pressure (IP: 985 <  $P$  < 1000), and a snow-melting period (MP: since DOY 446), all shown in Table 1. The temperature was much higher for LP than for HP – a difference of over 10 °C on average.

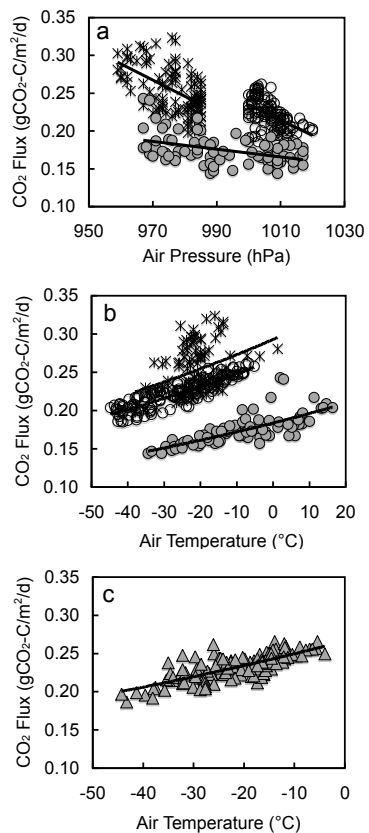

**Fig. 7.** Relationships between winter CO<sub>2</sub> flux and: **(a)** atmospheric pressure during HP, LP, and MP; **(b)** ambient temperature during HP, LP, and MP; **(c)** ambient temperature during IP. The empty area for IP in **(a)** and **(b)** denotes exclusion between 985 and 1000 hPa. Winter CO<sub>2</sub> fluxes show good exponential relations with ambient temperature for four pressure phases. The symbols are open circles for HP, stars for LP, solid circles for MP, and solid triangles for IP.

**Environmental factors regulating winter CO<sub>2</sub> flux**

Y. Kim and Y. Kodama

Title Page

Abstract

Introduction

Conclusions

References

Tables

Figures

◀

▶

◀

▶

Back

Close

Full Screen / Esc

Printer-friendly Version

Interactive Discussion



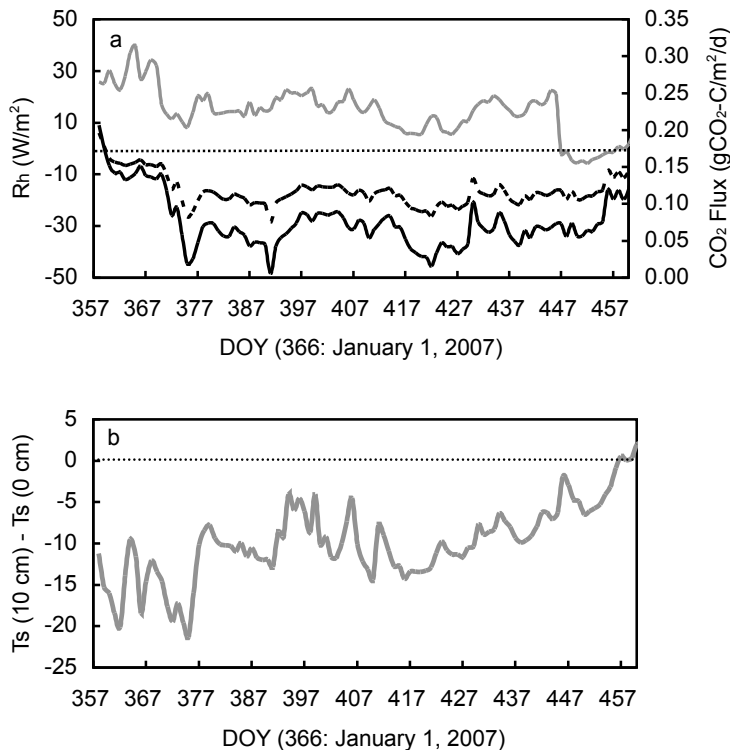

**Fig. 8. (a)** Temporal variations in winter  $CO_2$  flux ( $g\ CO_2-C\ m^{-2}\ d^{-1}$ ;) and soil non-conductive heat flux,  $R_h$  ( $W\ m^{-2}$ ), estimated from equation (1), as written in the text. Both fluxes were averaged on a daily basis.  $CO_2$  flux is represented by a solid grey line.  $R_h$  was estimated for upper bounds (solid black line,  $\{d_h, c_h\} = \{8.0 \times 10^{-7}\ m^2\ s^{-1}$  and  $2.4 \times 10^6\ J/m/K\}$ ) and lower bounds (dashed black line,  $\{d_h, c_h\} = \{5.5 \times 10^{-7}\ m^2\ s^{-1}$ ,  $2.0 \times 10^6\ J/m/K\}$ ). **(b)** Snow temperature gradients between the soil surface and 10 cm above, from DOY 357 to 460.  $T_s(0\ cm)$  and  $T_s(10\ cm)$  denote temperatures at soil surface and at 10 cm above the surface.

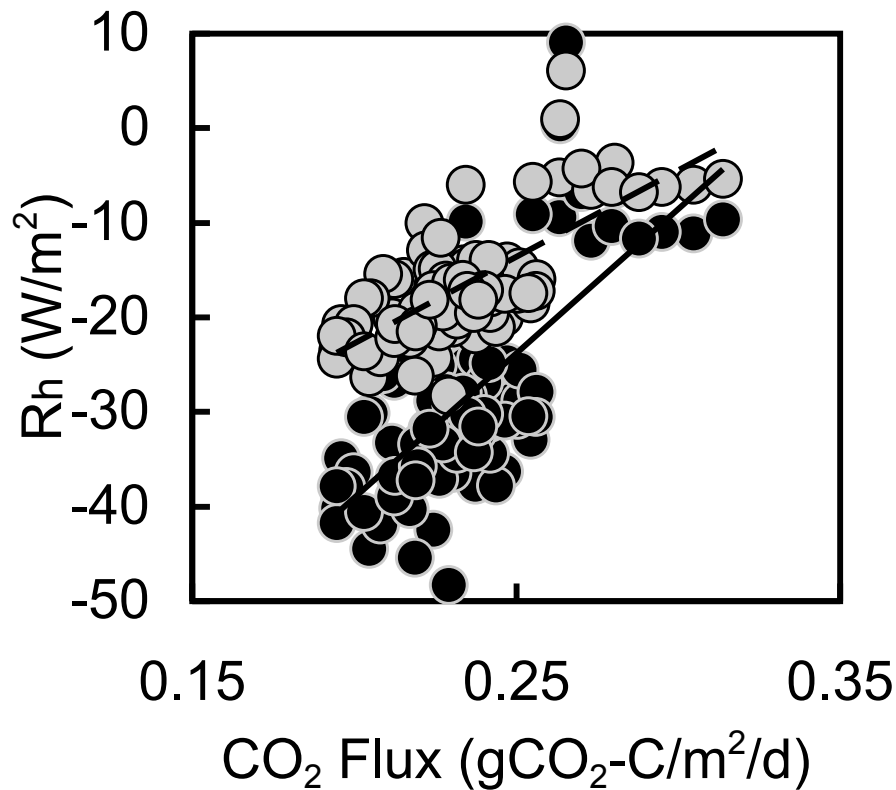

**Fig. 9.** Correlations between non-conductive heat and winter CO<sub>2</sub> flux until DOY 445. Solid and grey circles are maximum and minimum soil heat flux, respectively, as described in Fig. 10. Solid and dashed lines show the relationships between winter CO<sub>2</sub> flux and soil non-conductive heat fluxes at maximum and minimum, respectively.

**Environmental factors regulating winter CO<sub>2</sub> flux**

Y. Kim and Y. Kodama

Title Page

Abstract

Introduction

Conclusions

References

Tables

Figures

◀

▶

◀

▶

Back

Close

Full Screen / Esc

Printer-friendly Version

Interactive Discussion



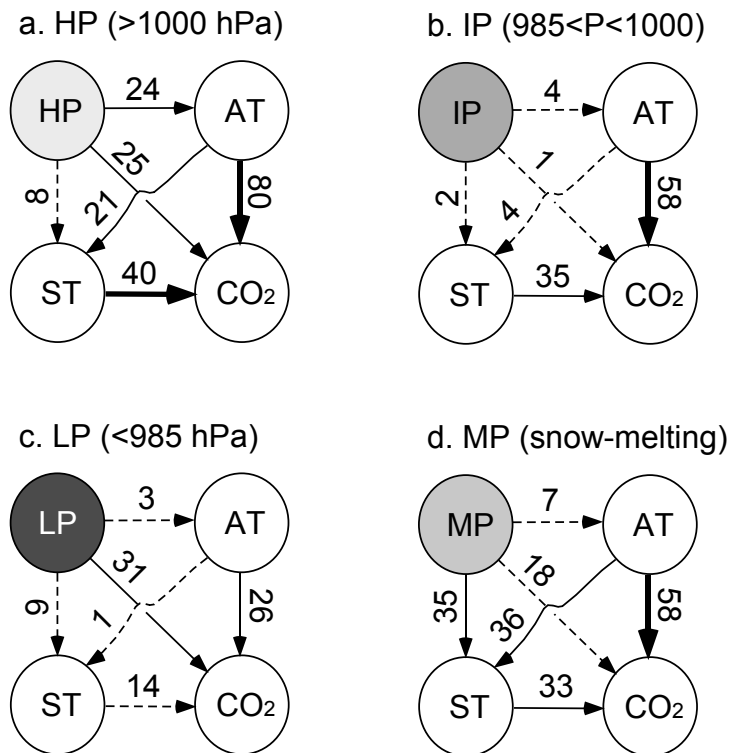

**Fig. 10.** The percentage (%) correlation, measured using the correlation coefficient ( $R^2$ ), between environmental factors and winter CO<sub>2</sub> flux during (a) HP, (b) IP, (c) LP, and (d) MP. The numbers on the lines are the percentages of correlation between both parameters. The dotted, thin solid, and thick solid lines denote  $R^2 < 0.20$ ,  $0.20 < R^2 < 0.40$ , and  $R^2 > 0.40$ , respectively.